



Prices effective February 5, 2018

Published August 2018

Canvas Office Landscape® Storage

Introduction	page 2
Metal Storage	3
Metal Case Lateral Files	5
Metal Case Lateral File Accessories	9
Metal Case Pedestals	13
Metal Case Pedestal Accessories	21
Metal Case Towers	27
Metal Case Credenzas	38
Metal Case Credenza Accessories	108
Metal Case Storage Organizers	112
Wood Storage	115
Wood Case Lateral Files	117
Wood Case Pedestals	121
Wood Case Cabinets and Bookcases	131
Wood Case Cabinets and Bookcases (Legacy Products)	164
Wood Case Credenzas	176
Wood Case Storage Organizers	277
Freestanding and Surface Attached Storage	281
Freestanding Storage	283
Attaching Storage	284
Attaching Storage (Legacy Products)	299
Accessories	307
Accessories (Legacy Products)	309
Indices	313
By Name	313
By Number	315
Appendices	
20-Day or Less/Assigned Lead-Time Order Information	
Keyed-Alike Information	
Vary Easy Program	
Stain-to-Match Program	
Customer's Own Material/Customer's Own Leather Order Information-Cushion Tops	
Proprietary Textiles Application Chart-Seating	
Proprietary Textile Colors-Seating	
Maharam® Application Chart-Seating	
Maharam Colors-Seating	
For the latest materials information, refer to the Materials pages on HermanMiller.com.	

Introduction

A Note on the Organization of This Book

There are a few signals that will help you understand the organization of this book. Once you know them, you should be able to find your way around easily.

Like a newspaper, this book is formatted with columns of text and illustrations that run vertically.

Information wraps from one column to the next and continues for as many pages as it needs to.

Black bars are clues.

A black bar at the top of a page signals the start of information about a product.

This information is divided into two sections, each signaled by a black bar. Product Information includes a description, additional notes, and dimensional drawings. Specification Information, which always begins at the top of a column, includes a series of steps. Each step represents a decision you need to make in order to complete your product number. Steps must be followed sequentially. The number of pages needed to complete information on a product varies; some will be complete in one page; others may fill three or four pages. Just continue going through the steps until you run into the next product, signaled by the black bar at the top of the page.

Black tabs running along the outside edge of the page help you locate what section you are in or what section you want to go to. You can thumb forwards or backwards to find a section; tabs and text appear on both sides of the page.

The additional pages in the back of the book include the appendices and indices. They are signaled by a long black bar running along the outside edge of the page.

The index is presented two ways.

The first index is in alphabetical order by product name. It can be helpful if you are new to the products and numbering scheme or if you are looking for a type of product, such as work chair or round table.

The second index is by product number. It lists, in alphanumeric order, the base product number, typically a five-digit number.

This book is effective February 5, 2018, subject to change without notice. Products may be purchased from authorized Herman Miller dealers who will quote prices upon request. For more information about our products and services or to see a list of dealers, visit www.HermanMiller.com.

All prices are list prices in US Dollars. Additional services, such as planning services, design, storage, and installation, are not included and must be added to these prices when the additional services are requested.

Illustrations, specifications, and prices are based on the latest information at the time of publication. The right is reserved to make changes at any time without notice in prices, fabrics, finishes, materials, specifications, and models, and also to discontinue models and finishes.

Dimensions shown in the drawings are engineering drawing dimensions rounded up to the nearest $\frac{1}{8}$ ". Product is shipped set up or knocked down. Products that include "Shipped knocked down" in the description require some assembly. If this statement does not appear in the description, the product is shipped assembled.

Service problems are normally handled by a Herman Miller authorized dealer. Where this cannot be accomplished on a local level, service problems should be referred to the Customer Care Representative for your region, Herman Miller, Inc., Zeeland, Michigan 49464.

20-Day or Less/Assigned Lead-Time Shipments

All products and options in this price book not designated by an Assigned Program icon  will ship in **20 business days or less** after being acknowledged by Herman Miller.

Products and options designated by an  are on the assigned lead-time program and may ship in 20 days, less than 20 days, or more than 20 days from order acknowledgement.

Metal Case Lateral Files

Metal Case Lateral File Accessories

Metal Case Pedestals

Metal Case Pedestal Accessories

Metal Case Towers

Metal Case Credenzas

Metal Case Credenza Accessories

Metal Case Storage Organizers

Metal Freestanding Lateral File

FM20A.
FM20K.

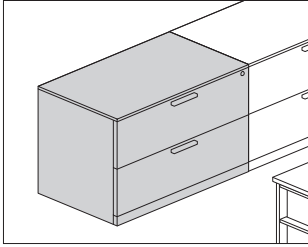

Product Information

Description

This lateral file has a $\frac{3}{8}$ "- or $\frac{1}{4}$ "-high laminate or veneer top and a painted steel case with a painted, laminate, or veneer front. It has a $2\frac{1}{4}$ "-high base with 1" leveling glides and a positive interlock system that permits only 1 drawer to open at a time. Drawers have full-extension ball-bearing slides and accommodate front-to-back filing of letter-, legal, and A4-size hanging files.

Actual file widths are $29\frac{7}{8}$ ", $35\frac{7}{8}$ ", or $41\frac{7}{8}$ "; actual depth is $19\frac{7}{8}$ ".

Notes

For additional product options, see Vary Easy Program in Appendices. Arc pull option (A.) conforms to guidelines of Americans with Disabilities Act (ADA).

File drawers are standard with side-to-side hardware. Order front-to-back rail (FM920.) separately.

Grain direction is vertical on veneer and wood-grain laminate fronts. For information on counterweight option (CB), see Canvas Planning Guide.

For keyed-alike locks, see Keyed-Alike Information in Appendices.

Dimensions

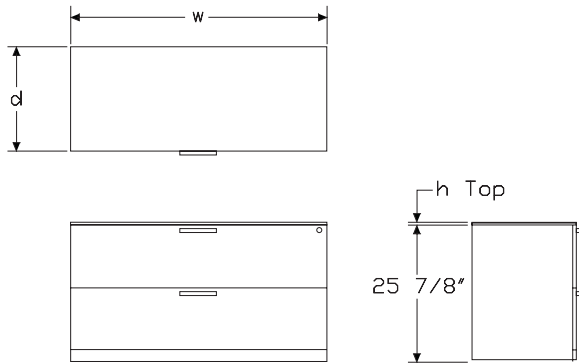

Specification Information

Step 1.

FM20 A

Step 2. Pull Type

A. arc pull A

K. bar pull A

Step 3. Width

30 30" wide A

36 36" wide A

42 42" wide A

Step 4. Depth

20 20" deep A

Step 5. Configuration

FF file/file A

Step 6. Base Height

2 $2\frac{1}{4}$ "-high base A

Step 7. Front Material

P painted metal front A

L laminate front A

W veneer front A

Step 8. Top

For file/file (FF) with painted metal front (P) or laminate front (L)

NT no top A

03 $\frac{3}{8}$ " laminate top A

04 $\frac{3}{8}$ " veneer top A

06 $1\frac{1}{4}$ " laminate top A

07 $1\frac{1}{4}$ " veneer top A

For file/file (FF) with veneer front (W)

NT no top A

04 $\frac{3}{8}$ " veneer top A

07 $1\frac{1}{4}$ " veneer top A

Step 9. Lock

L lock A

Prices for Steps 1-9.

	FF2PNTL	FF2P03L	FF2P04L	FF2P06L	FF2P07L	FF2LNTL
FM20A.30 20	\$1729	1846	2082	1846	2082	1848

Metal Freestanding Lateral File

continued

Canvas Office Landscape® Metal Case Lateral Files

36 20	\$1929	2046	2282	2046	2282	2048
42 20	\$2128	2246	2483	2246	2483	2249

	FF2L03L	FF2L04L	FF2L06L	FF2L07L	FF2WNTL	FF2W04L
FM20A.30 20	\$1967	2203	1967	2203	2512	2866
36 20	\$2168	2401	2168	2401	2702	3054
42 20	\$2368	2602	2368	2602	3148	3254

	FF2PNTL	FF2P03L	FF2P04L	FF2P06L	FF2P07L	FF2LNTL
FM20K.30 20	\$1729	1846	2082	1846	2082	1848
36 20	\$1929	2046	2282	2046	2282	2048
42 20	\$2128	2246	2483	2246	2483	2249

	FF2L03L	FF2L04L	FF2L06L	FF2L07L	FF2WNTL	FF2W04L
FM20K.30 20	\$1967	2203	1967	2203	2512	2866
36 20	\$2168	2401	2168	2401	2702	3054
42 20	\$2368	2602	2368	2602	3148	3254

	FF2W07L
FM20K.30 20	\$2866
36 20	\$3054
42 20	\$3254

Step 10. Paint/Steel Type

SS	smooth paint on smooth steel <input type="checkbox"/>	+\$0
XS	textured paint on smooth steel <input type="checkbox"/>	+\$0

Step 11. Surface Finish

Metallic Paint

For smooth paint on smooth steel (SS)

CN	metallic champagne <input type="checkbox"/>	+\$0
EH	metallic bronze <input type="checkbox"/>	+\$0
MS	metallic silver <input type="checkbox"/>	+\$0

Sand Texture Paint

For textured paint on smooth steel (XS)

8Q	folkstone grey <input type="checkbox"/>	+\$0
98	studio white <input type="checkbox"/>	+\$0
WL	sandstone <input type="checkbox"/>	+\$0

Bright Sand Texture Paint

For textured paint on smooth steel (XS)

91	white <input type="checkbox"/>	+\$0
CL	cool grey neutral <input type="checkbox"/>	+\$0
G1	graphite <input type="checkbox"/>	+\$0
WN	warm grey neutral <input type="checkbox"/>	+\$0

Step 12. Front Finish

Solid-Color Laminate

For laminate front (L)

8Q	folkstone grey <input type="checkbox"/>	+\$0
91	white <input type="checkbox"/>	+\$0
98	studio white	+\$0
CL	cool grey neutral <input type="checkbox"/>	+\$0
LU	soft white <input type="checkbox"/>	+\$0
WL	sandstone <input type="checkbox"/>	+\$0
WN	warm grey neutral <input type="checkbox"/>	+\$0

Linen Laminate

For laminate front (L)

LBM	crisp linen	+\$0
LBN	classic linen	+\$0
LBP	casual linen	+\$0

Mesh Laminate

For laminate front (L)

LBK	pewter mesh	+\$0
LBL	steel mesh	+\$0

Twill Laminate

For laminate front (L)

LBF	neutral twill	+\$0
LBG	sarum twill	+\$0
LBH	earthen twill	+\$0
LBJ	graphite twill	+\$0
LBQ	white twill	+\$0

Metal Freestanding Lateral File

continued

Wood-Grain Laminate		
<i>For laminate front (L)</i>		
HM	natural maple <input type="checkbox"/>	+\$0
HP	light anigre <input type="checkbox"/>	+\$0
LBA	clear on ash	+\$0
LBR	phantom ecru	+\$0
LBS	phantom cocoa	+\$0
LBU	medium matte walnut	+\$0
LBV	warm grey teak	+\$0
LBB	oak on ash	+\$0
LBC	walnut on ash	+\$0
LBD	dark brown walnut	+\$0
LBE	medium red walnut	+\$0
76	light brown walnut <input type="checkbox"/>	+\$0
HX	aged cherry <input type="checkbox"/>	+\$0
HY	walnut on cherry <input type="checkbox"/>	+\$0

Wood Veneer		
<i>For veneer front (W)</i>		
2U	light brown walnut <input type="checkbox"/>	+\$0
40	dark brown walnut <input type="checkbox"/>	+\$0
ED	aged cherry <input type="checkbox"/>	+\$0
EK	medium red walnut <input type="checkbox"/>	+\$0
EW	medium matte walnut <input type="checkbox"/>	+\$0
ET	clear on ash <input type="checkbox"/>	+\$0
EU	oak on ash <input type="checkbox"/>	+\$0
EV	walnut on ash <input type="checkbox"/>	+\$0
UL	natural maple <input type="checkbox"/>	+\$0
UX	walnut on cherry <input type="checkbox"/>	+\$0

Step 13. Top Finish

Solid-Color Laminate		
<i>For 3/8" laminate top (03) or 1 1/4" laminate top (06)</i>		
8Q	folkstone grey <input type="checkbox"/>	+\$0
91	white <input type="checkbox"/>	+\$0
98	studio white	+\$0
CL	cool grey neutral <input type="checkbox"/>	+\$0
LU	soft white <input type="checkbox"/>	+\$0
WL	sandstone <input type="checkbox"/>	+\$0
WN	warm grey neutral <input type="checkbox"/>	+\$0

Linen Laminate		
<i>For 3/8" laminate top (03) or 1 1/4" laminate top (06)</i>		
LBM	crisp linen	+\$0
LBN	classic linen	+\$0
LBP	casual linen	+\$0

Mesh Laminate		
<i>For 3/8" laminate top (03) or 1 1/4" laminate top (06)</i>		
LBK	pewter mesh	+\$0
LBL	steel mesh	+\$0

Twill Laminate		
<i>For 3/8" laminate top (03) or 1 1/4" laminate top (06)</i>		
LBF	neutral twill	+\$0
LBG	sarum twill	+\$0
LBH	earthen twill	+\$0
LBJ	graphite twill	+\$0
LBQ	white twill	+\$0

Wood-Grain Laminate		
<i>For 3/8" laminate top (03) or 1 1/4" laminate top (06)</i>		
HM	natural maple <input type="checkbox"/>	+\$0
HP	light anigre <input type="checkbox"/>	+\$0
LBA	clear on ash	+\$0
LBR	phantom ecru	+\$0
LBS	phantom cocoa	+\$0
LBU	medium matte walnut	+\$0
LBV	warm grey teak	+\$0
LBB	oak on ash	+\$0
LBC	walnut on ash	+\$0
LBD	dark brown walnut	+\$0
LBE	medium red walnut	+\$0
76	light brown walnut <input type="checkbox"/>	+\$0
HX	aged cherry <input type="checkbox"/>	+\$0
HY	walnut on cherry <input type="checkbox"/>	+\$0

Wood Veneer		
<i>For 3/8" veneer top (04) or 1 1/4" veneer top (07)</i>		
2U	light brown walnut <input type="checkbox"/>	+\$0
40	dark brown walnut <input type="checkbox"/>	+\$0
ED	aged cherry <input type="checkbox"/>	+\$0
EK	medium red walnut <input type="checkbox"/>	+\$0
EW	medium matte walnut <input type="checkbox"/>	+\$0
ET	clear on ash <input type="checkbox"/>	+\$0
EU	oak on ash <input type="checkbox"/>	+\$0
EV	walnut on ash <input type="checkbox"/>	+\$0
UL	natural maple <input type="checkbox"/>	+\$0
UX	walnut on cherry <input type="checkbox"/>	+\$0

Metal Freestanding Lateral File

continued

Canvas Office Landscape® Metal Case Lateral Files

Step 14. Pull Finish

For arc pull (A.)

NH	brushed nickel <input type="checkbox"/>	+\$0
NK	black nickel <input type="checkbox"/>	+\$0

For bar pull (K.)

8Q	folkstone grey	+\$0
91	white	+\$0
98	studio white <input type="checkbox"/>	+\$0
G1	graphite <input type="checkbox"/>	+\$0
WL	sandstone <input type="checkbox"/>	+\$0
CN	metallic champagne <input type="checkbox"/>	+\$0
MS	metallic silver <input type="checkbox"/>	+\$0
79	green apple <input type="checkbox"/>	+\$15
MY3	yellow oxide <input type="checkbox"/>	+\$15
RO	red <input type="checkbox"/>	+\$15
TRQ	turquoise <input type="checkbox"/>	+\$15

Step 15. Counterweight

NO	no counterweight <input type="checkbox"/>	+\$0
CB	counterweight <input type="checkbox"/>	+\$115

Step 16. Lock Option

KA	keyed alike, black <input type="checkbox"/>	-\$10
KC	keyed differently, chrome <input type="checkbox"/>	+\$0
KD	keyed differently, black <input type="checkbox"/>	+\$0

Front-to-Back Filing Rail

FM920.

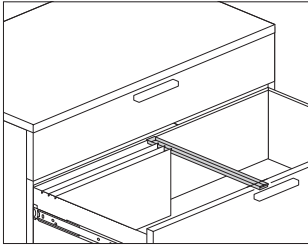

Product Information

Description

This filing rail holds letter-size files for front-to-back filing. The 18"-deep rail is used in a metal low credenza. The 20"-deep rail is used in a metal lateral file. Finish is black umber.

Dimensions

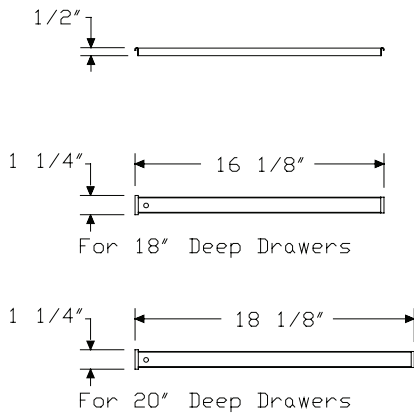

Specification Information

Step 1.

FM920.

Step 2. Width

- 00** for 30"- or 42"-wide drawers
- 36** for 36"-wide drawers

Step 3. Depth

- 18** for 18"-deep low credenza file drawer
- 20** for 20"-deep 2-high lateral file drawer

Prices for Steps 1-3.

	18	20
FM920.00	\$33	33
36	\$33	33

Side-to-Side Filing Rail

FM921.

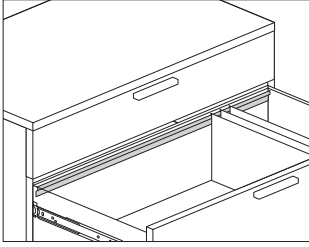

Canvas Office Landscape® Metal Case Lateral File Accessories

Product Information

Description
 This filing rail holds letter- or legal-sized hanging folder for side-to-side filing in a metal low credenza or lateral file. Finish is black umber.

Dimensions

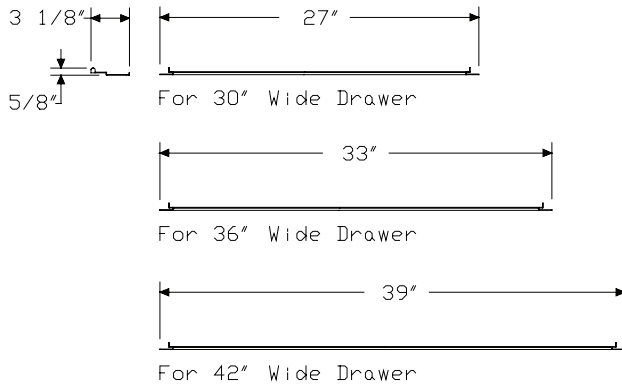

Specification Information

Step 1.

FM921.

Step 2. Quantity

- 1** 1 filing rail
- 2** 2 filing rails

Step 3. Width

- 30** for 30"-wide drawers
- 36** for 36"-wide drawers
- 42** for 42"-wide drawers

Prices for Steps 1-3.

	30	36	42
FM921. 1	\$24	24	24
2	\$47	47	47

Movable Divider

FM922.
FM929.

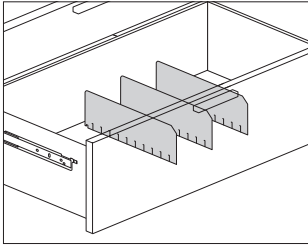

Product Information

Description

This adjustable metal divider fits into slots of a metal low credenza or lateral file drawer. The 18"-deep divider is used in a metal low credenza. The 20"-deep divider is used in a metal lateral file. Finish is black umber.

Dimensions

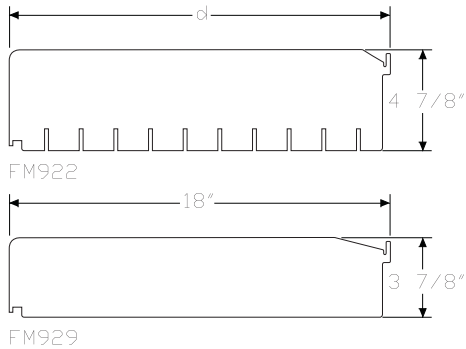

Specification Information

Step 1.

FM92

Step 2. Type

- 2. file drawer divider
- 9. credenza box drawer divider

Step 3. Quantity

- 1 1 divider
- 3 3 dividers

Step 4. Depth

For file drawer divider (2.)

- 18 for 18"-deep low credenza
- 20 for 20"-deep 2-high lateral file

For credenza box drawer divider (9.)

- 18 for 18"-deep low credenza

Prices for Steps 1-4.

	18	20
FM922. 1	\$34	34
3	\$85	85
FM929. 1	\$34	—
3	\$85	—

File Drawer Organizer

FM923.

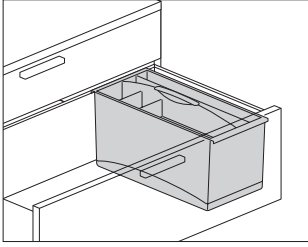

Product Information

Description

This 2-piece plastic organizer fits into any file drawer configured for letter-size filing. It has a removable top tray with sections for storing small items, and a bottom bin that can hold larger items or be divided into 3 sections; 2 vertical dividers included. Finish is black umber.

Dimensions

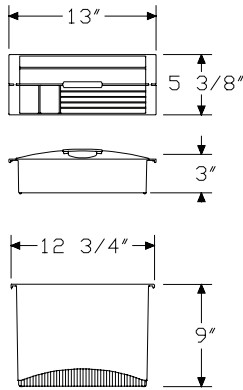

Specification Information

Step 1.

FM923.

\$85

Metal Freestanding Pedestal

FM10A.
FM10K.

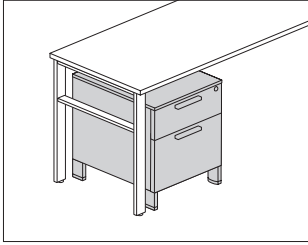

Product Information

Description

This pedestal has a $\frac{3}{8}$ "- or $1\frac{1}{4}$ "-high laminate or veneer top and a painted steel case with a painted, laminate, or veneer front. It is available with $\frac{1}{4}$ "-high architectural feet or a $2\frac{1}{4}$ "-high base with leveling glides. Architectural feet and glides have 1" adjustment range. The drawers have full-extension ball-bearing slides. File drawers accommodate front-to-back filing of letter-size hanging files. Actual pedestal depths are $17\frac{7}{8}$ ", $21\frac{7}{8}$ ", or $27\frac{7}{8}$ ".

Notes

For additional product options, see Vary Easy Program in Appendices.
Arc pull option (A.) conforms to guidelines of Americans with Disabilities Act (ADA).
Grain direction is vertical on veneer and wood-grain laminate fronts.
For additional stability, specify counterweight option (CB).
For keyed-alike locks, see Keyed-Alike Information in Appendices.

Dimensions

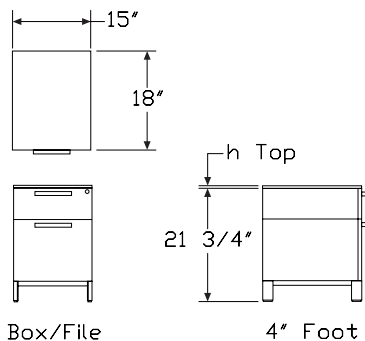
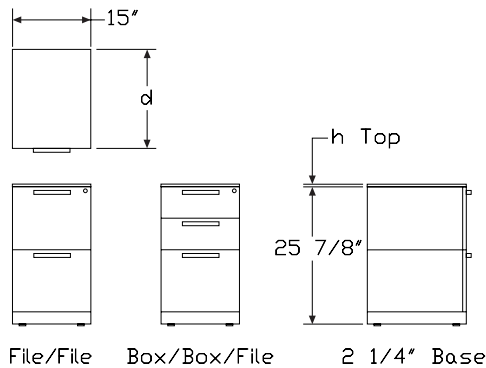

Specification Information

Step 1.

FM10

Step 2. Pull Type

- A.** arc pull
- K.** bar pull

Step 3. Depth

- 18** 18" deep
- 22** 22" deep A
- 28** 28" deep A

Step 4. Configuration

For 18" deep (18)

- BBF** box/box/file
- BF** box/file
- FF** file/file

For 22" deep (22) or 28" deep (28)

- BBF** box/box/file
- FF** file/file

Step 5. Base/Foot Height

For box/box/file (BBF) or file/file (FF)

- 2** $2\frac{1}{4}$ "-high base

For box/file (BF)

- 2** $2\frac{1}{4}$ "-high base
- 4** 4"-high foot

Step 6. Front Material

- P** painted metal front
- L** laminate front
- W** veneer front A

Step 7. Top

For box/file (BF) with painted metal front (P) or laminate front (L)

- 03** $\frac{3}{8}$ " laminate top
- 04** $\frac{3}{8}$ " veneer top A

For box/file (BF) with veneer front (W)

- 04** $\frac{3}{8}$ " veneer top A

Metal Freestanding Pedestal

continued

Canvas Office Landscape® Metal Case Pedestals

For box/box/file (BBF) or file/file (FF) with painted metal front (P) or laminate front (L)

03	3/8" laminate top
04	3/8" veneer top <input type="checkbox"/> A
06	1 1/4" laminate top
07	1 1/4" veneer top <input type="checkbox"/> A

For box/box/file (BBF) or file/file (FF) with veneer front (W)

04	3/8" veneer top <input type="checkbox"/> A
07	1 1/4" veneer top <input type="checkbox"/> A

Step 8. Lock

L	lock
----------	------

Prices for Steps 1-8.

	2P03L	2P06L	2P04L	2P07L	2L03L	2L06L
FM10A.18 BBF	\$1141	1141	1258	1258	1208	1208
BF	\$1063	—	1182	—	1128	—
FF	\$1110	1110	1228	1228	1177	1177
22 BBF	\$1341	1341	1475	1475	1418	1418
FF	\$1304	1304	1440	1440	1384	1384
28 BBF	\$1372	1372	1506	1506	1447	1447
FF	\$1335	1335	1486	1486	1412	1412

	2L04L	2L07L	2W04L	2W07L	4P03L	4P04L
FM10A.18 BBF	\$1326	1326	1726	1726	—	—
BF	\$1245	—	1637	—	1324	1459
FF	\$1295	1295	1587	1587	—	—
22 BBF	\$1554	1554	1961	1961	—	—
FF	\$1519	1519	1823	1823	—	—
28 BBF	\$1584	1584	2183	2183	—	—
FF	\$1548	1548	2058	2058	—	—

	4L03L	4L04L	4W04L
FM10A.18 BF	\$1399	1534	1983

	2P03L	2P06L	2P04L	2P07L	2L03L	2L06L
FM10K.18 BBF	\$1141	1141	1258	1258	1208	1208
BF	\$1063	—	1182	—	1128	—
FF	\$1110	1110	1228	1228	1177	1177
22 BBF	\$1341	1341	1475	1475	1418	1418
FF	\$1304	1304	1440	1440	1384	1384
28 BBF	\$1372	1372	1506	1506	1447	1447
FF	\$1335	1335	1486	1486	1412	1412

	2L04L	2L07L	2W04L	2W07L	4P03L	4P04L
FM10K.18 BBF	\$1326	1326	1726	1726	—	—
BF	\$1245	—	1637	—	1324	1459
FF	\$1295	1295	1587	1587	—	—
22 BBF	\$1554	1554	1961	1961	—	—
FF	\$1519	1519	1823	1823	—	—
28 BBF	\$1584	1584	2183	2183	—	—
FF	\$1548	1548	2058	2058	—	—

	4L03L	4L04L	4W04L
FM10K.18 BF	\$1399	1534	1726

Step 9. Paint/Steel Type

SS	smooth paint on smooth steel	+\$0
XS	textured paint on smooth steel	+\$0

Step 10. Surface Finish

Metallic Paint

For smooth paint on smooth steel (SS)

CN	metallic champagne	+\$0
EH	metallic bronze	+\$0
MS	metallic silver	+\$0

Sand Texture Paint

For textured paint on smooth steel (XS)

98	studio white <input type="checkbox"/> A	+\$0
8Q	folkstone grey <input type="checkbox"/> A	+\$0
WL	sandstone <input type="checkbox"/> A	+\$0

Bright Sand Texture Paint

For textured paint on smooth steel (XS)

91	white	+\$0
CL	cool grey neutral <input type="checkbox"/> A	+\$0
G1	graphite <input type="checkbox"/> A	+\$0
WN	warm grey neutral	+\$0

Metal Freestanding Pedestal

continued

Step 11. Front Finish

Solid-Color Laminate

For laminate front (L)

8Q	folkstone grey <input type="checkbox"/>	+\$0
91	white	+\$0
98	studio white	+\$0
CL	cool grey neutral <input type="checkbox"/>	+\$0
LU	soft white <input type="checkbox"/>	+\$0
WL	sandstone <input type="checkbox"/>	+\$0
WN	warm grey neutral	+\$0

Linen Laminate

For laminate front (L)

LBM	crisp linen	+\$0
LBN	classic linen	+\$0
LBP	casual linen	+\$0

Mesh Laminate

For laminate front (L)

LBK	pewter mesh	+\$0
LBL	steel mesh	+\$0

Twill Laminate

For laminate front (L)

LBF	neutral twill	+\$0
LBG	sarum twill	+\$0
LBH	earthen twill	+\$0
LBJ	graphite twill	+\$0
LBQ	white twill	+\$0

Wood-Grain Laminate

For laminate front (L)

HM	natural maple	+\$0
HP	light anigre <input type="checkbox"/>	+\$0
LBA	clear on ash	+\$0
LBR	phantom ecru	+\$0
LBS	phantom cocoa	+\$0
LBU	medium matte walnut	+\$0
LBV	warm grey teak	+\$0
LBB	oak on ash	+\$0
LBC	walnut on ash	+\$0
LBD	dark brown walnut	+\$0
LBE	medium red walnut	+\$0
76	light brown walnut <input type="checkbox"/>	+\$0
HX	aged cherry	+\$0
HY	walnut on cherry <input type="checkbox"/>	+\$0

Wood Veneer

For veneer front (W)

2U	light brown walnut <input type="checkbox"/>	+\$0
40	dark brown walnut <input type="checkbox"/>	+\$0
ED	aged cherry <input type="checkbox"/>	+\$0
EK	medium red walnut <input type="checkbox"/>	+\$0
EW	medium matte walnut <input type="checkbox"/>	+\$0
ET	clear on ash <input type="checkbox"/>	+\$0
EU	oak on ash <input type="checkbox"/>	+\$0
EV	walnut on ash <input type="checkbox"/>	+\$0
UL	natural maple <input type="checkbox"/>	+\$0
UX	walnut on cherry <input type="checkbox"/>	+\$0

Step 12. Top Finish

Solid-Color Laminate

For 3/8" laminate top (o3) or 1 1/4" laminate top (o6)

8Q	folkstone grey <input type="checkbox"/>	+\$0
91	white	+\$0
98	studio white	+\$0
CL	cool grey neutral <input type="checkbox"/>	+\$0
LU	soft white <input type="checkbox"/>	+\$0
WL	sandstone <input type="checkbox"/>	+\$0
WN	warm grey neutral	+\$0

Linen Laminate

For 3/8" laminate top (o3) or 1 1/4" laminate top (o6)

LBM	crisp linen	+\$0
LBN	classic linen	+\$0
LBP	casual linen	+\$0

Mesh Laminate

For 3/8" laminate top (o3) or 1 1/4" laminate top (o6)

LBK	pewter mesh	+\$0
LBL	steel mesh	+\$0

Twill Laminate

For 3/8" laminate top (o3) or 1 1/4" laminate top (o6)

LBF	neutral twill	+\$0
LBG	sarum twill	+\$0
LBH	earthen twill	+\$0
LBJ	graphite twill	+\$0
LBQ	white twill	+\$0

Metal Freestanding Pedestal

continued

Canvas Office Landscape® Metal Case Pedestals

Wood-Grain Laminate

For 3/8" laminate top (03) or 1 1/4" laminate top (06)

HM	natural maple	+\$0
HP	light anigre <input type="checkbox"/>	+\$0
LBA	clear on ash	+\$0
LBR	phantom ecru	+\$0
LBS	phantom cocoa	+\$0
LBU	medium matte walnut	+\$0
LBV	warm grey teak	+\$0
LBB	oak on ash	+\$0
LBC	walnut on ash	+\$0
LBD	dark brown walnut	+\$0
LBE	medium red walnut	+\$0
76	light brown walnut <input type="checkbox"/>	+\$0
HX	aged cherry	+\$0
HY	walnut on cherry <input type="checkbox"/>	+\$0

Wood Veneer

For 3/8" veneer top (04) or 1 1/4" veneer top (07)

2U	light brown walnut <input type="checkbox"/>	+\$0
40	dark brown walnut <input type="checkbox"/>	+\$0
ED	aged cherry <input type="checkbox"/>	+\$0
EK	medium red walnut <input type="checkbox"/>	+\$0
EW	medium matte walnut <input type="checkbox"/>	+\$0
ET	clear on ash <input type="checkbox"/>	+\$0
EU	oak on ash <input type="checkbox"/>	+\$0
EV	walnut on ash <input type="checkbox"/>	+\$0
UL	natural maple <input type="checkbox"/>	+\$0
UX	walnut on cherry <input type="checkbox"/>	+\$0

Step 13. Base Finish

For 4"-high foot (4)

8Q	folkstone grey <input type="checkbox"/>	+\$0
98	studio white <input type="checkbox"/>	+\$0
WL	sandstone <input type="checkbox"/>	+\$0

Bright Sand Texture Paint

91	white	+\$0
CL	cool grey neutral <input type="checkbox"/>	+\$0
G1	graphite <input type="checkbox"/>	+\$0
WN	warm grey neutral	+\$0

Metallic Paint

CN	metallic champagne	+\$0
EH	metallic bronze	+\$0
MS	metallic silver	+\$0

Step 14. Pull Finish

For arc pull (A.)

NH	brushed nickel	+\$0
NK	black nickel <input type="checkbox"/>	+\$0

For bar pull (K.)

8Q	folkstone grey	+\$0
91	white	+\$0
98	studio white	+\$0
G1	graphite <input type="checkbox"/>	+\$0
WL	sandstone <input type="checkbox"/>	+\$0
CN	metallic champagne <input type="checkbox"/>	+\$0
MS	metallic silver	+\$0
79	green apple <input type="checkbox"/>	+\$15
MY3	yellow oxide <input type="checkbox"/>	+\$15
RO	red <input type="checkbox"/>	+\$15
TRQ	turquoise <input type="checkbox"/>	+\$15

Step 15. Counterweight

NO	no counterweight	+\$0
CB	counterweight	+\$88

Step 16. Lock Option

KA	keyed alike	-\$10
KC	keyed differently, chrome	+\$0
KD	keyed differently, black	+\$0

Metal Mobile Pedestal

FM11A.
FM11K.

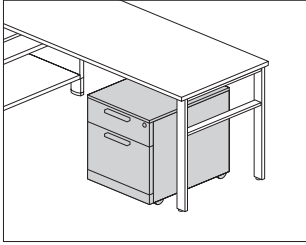

Product Information

Description

This pedestal has a $\frac{3}{8}$ "-high laminate or veneer top and a painted steel case with a painted, laminate, or veneer front. It has concealed casters and full-extension ball-bearing slides on the drawers. File drawers accommodate front-to-back filing of letter-size hanging files. Actual pedestal depth is $17\frac{7}{8}$ ".

Notes

For additional product options, see Vary Easy Program in Appendices. Arc pull option (A.) conforms to guidelines of Americans with Disabilities Act (ADA). Grain direction is vertical on veneer and wood-grain laminate fronts. For keyed-alike locks, see Keyed-Alike Information in Appendices.

Dimensions

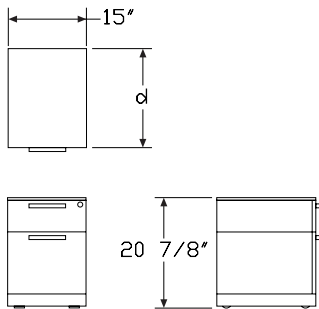

Specification Information

Step 1.

FM11

Step 2. Pull Type

- A.** arc pull
- K.** bar pull

Step 3. Depth

18 18" deep

Step 4. Configuration

BF box/file

Step 5. Front Material

- P** painted metal front
- L** laminate front
- W** veneer front A

Step 6. Top

For box/file (BF) with painted metal front (P) or laminate front (L)

- 03** $\frac{3}{8}$ " laminate top
- 04** $\frac{3}{8}$ " veneer top A

For box/file (BF) with veneer front (W)

- 04** $\frac{3}{8}$ " veneer top A

Step 7. Lock

- L** lock

Prices for Steps 1-7.

	P03L	P04L	L03L	L04L	W04L
FM11A. 18 BF	\$1125	1243	1190	1307	1700
FM11K. 18 BF	\$1125	1243	1190	1307	1700

Step 8. Paint/Steel Type

- SS** smooth paint on smooth steel +\$0
- XS** textured paint on smooth steel +\$0

Metal Mobile Pedestal *continued*

Step 9. Surface Finish

Metallic Paint		
<i>For smooth paint on smooth steel (SS)</i>		
CN	metallic champagne	+\$0
EH	metallic bronze	+\$0
MS	metallic silver	+\$0

Sand Texture Paint		
<i>For textured paint on smooth steel (XS)</i>		
8Q	folkstone grey A	+\$0
98	studio white A	+\$0
WL	sandstone A	+\$0

Bright Sand Texture Paint		
<i>For textured paint on smooth steel (XS)</i>		
91	white	+\$0
CL	cool grey neutral A	+\$0
G1	graphite A	+\$0
WN	warm grey neutral	+\$0

Step 10. Front Finish

Solid-Color Laminate		
<i>For laminate front (L)</i>		
8Q	folkstone grey A	+\$0
91	white	+\$0
98	studio white	+\$0
CL	cool grey neutral A	+\$0
LU	soft white A	+\$0
WL	sandstone A	+\$0
WN	warm grey neutral	+\$0

Linen Laminate		
<i>For laminate front (L)</i>		
LBM	crisp linen	+\$0
LBN	classic linen	+\$0
LBP	casual linen	+\$0

Mesh Laminate		
<i>For laminate front (L)</i>		
LBK	pewter mesh	+\$0
LBL	steel mesh	+\$0

Twill Laminate		
<i>For laminate front (L)</i>		
LBF	neutral twill	+\$0
LBG	sarum twill	+\$0
LBH	earthen twill	+\$0
LBJ	graphite twill	+\$0
LBQ	white twill	+\$0

Wood-Grain Laminate		
<i>For laminate front (L)</i>		
HM	natural maple	+\$0
HP	light anigre A	+\$0
LBA	clear on ash	+\$0
LBR	phantom ecru	+\$0
LBS	phantom cocoa	+\$0
LBU	medium matte walnut	+\$0
LBV	warm grey teak	+\$0
LBB	oak on ash	+\$0
LBC	walnut on ash	+\$0
LBD	dark brown walnut	+\$0
LBE	medium red walnut	+\$0
76	light brown walnut A	+\$0
HX	aged cherry	+\$0
HY	walnut on cherry A	+\$0

Wood Veneer		
<i>For veneer front (W)</i>		
2U	light brown walnut A	+\$0
40	dark brown walnut A	+\$0
ED	aged cherry A	+\$0
EK	medium red walnut A	+\$0
EW	medium matte walnut A	+\$0
ET	clear on ash A	+\$0
EU	oak on ash A	+\$0
EV	walnut on ash A	+\$0
UL	natural maple A	+\$0
UX	walnut on cherry A	+\$0

Metal Mobile Pedestal *continued*

Step 11. Top Finish

Solid-Color Laminate

For 3/8" laminate top (03)

8Q	folkstone grey <input type="checkbox"/>	+\$0
91	white	+\$0
98	studio white	+\$0
CL	cool grey neutral <input type="checkbox"/>	+\$0
LU	soft white <input type="checkbox"/>	+\$0
WL	sandstone <input type="checkbox"/>	+\$0
WN	warm grey neutral	+\$0

Linen Laminate

For 3/8" laminate top (03)

LBM	crisp linen	+\$0
LBN	classic linen	+\$0
LBP	casual linen	+\$0

Mesh Laminate

For 3/8" laminate top (03)

LBK	pewter mesh	+\$0
LBL	steel mesh	+\$0

Twill Laminate

For 3/8" laminate top (03)

LBF	neutral twill	+\$0
LBG	sarum twill	+\$0
LBH	earthen twill	+\$0
LBJ	graphite twill	+\$0
LBQ	white twill	+\$0

Wood-Grain Laminate

For 3/8" laminate top (03)

HM	natural maple	+\$0
HP	light anigre <input type="checkbox"/>	+\$0
LBA	clear on ash	+\$0
LBR	phantom ecru	+\$0
LBS	phantom cocoa	+\$0
LBU	medium matte walnut	+\$0
LBV	warm grey teak	+\$0
LBB	oak on ash	+\$0
LBC	walnut on ash	+\$0
LBD	dark brown walnut	+\$0
LBE	medium red walnut	+\$0
76	light brown walnut <input type="checkbox"/>	+\$0
HX	aged cherry	+\$0
HY	walnut on cherry <input type="checkbox"/>	+\$0

Wood Veneer

For 3/8" veneer top (04)

2U	light brown walnut <input type="checkbox"/>	+\$0
40	dark brown walnut <input type="checkbox"/>	+\$0
ED	aged cherry <input type="checkbox"/>	+\$0
EK	medium red walnut <input type="checkbox"/>	+\$0
EW	medium matte walnut <input type="checkbox"/>	+\$0
ET	clear on ash <input type="checkbox"/>	+\$0
EU	oak on ash <input type="checkbox"/>	+\$0
EV	walnut on ash <input type="checkbox"/>	+\$0
UL	natural maple <input type="checkbox"/>	+\$0
UX	walnut on cherry <input type="checkbox"/>	+\$0

Step 12. Pull Finish

For arc pull (A.)

NH	brushed nickel	+\$0
NK	black nickel <input type="checkbox"/>	+\$0

For bar pull (K.)

8Q	folkstone grey	+\$0
91	white	+\$0
98	studio white	+\$0
G1	graphite <input type="checkbox"/>	+\$0
WL	sandstone <input type="checkbox"/>	+\$0
CN	metallic champagne <input type="checkbox"/>	+\$0
MS	metallic silver	+\$0
79	green apple <input type="checkbox"/>	+\$15
MY3	yellow oxide <input type="checkbox"/>	+\$15
RO	red <input type="checkbox"/>	+\$15
TRQ	turquoise <input type="checkbox"/>	+\$15

Step 13. Lock Option

KA	keyed alike	-\$10
KC	keyed differently, chrome	+\$0
KD	keyed differently, black	+\$0

Pedestal Cushion Top

FM893.

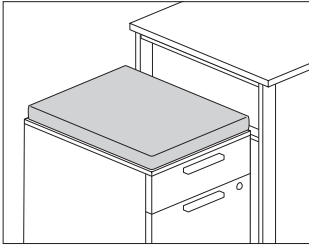

Canvas Office Landscape® Metal Case Pedestals

Product Information

Description
This cushion attaches to the top of a freestanding or mobile pedestal to provide temporary guest seating. Attachment hardware included.

Notes
Pedestal cushion accepts Customer's Own Material (COM). Yardage is estimated for nondirectional, 54"-wide fabrics. Order 1/2 yard of fabric per cushion. For odd number of cushions, round up to next full yard. For information on multiple quantities or directional fabrics, contact COM Department. See Order Information in Appendices.

Dimensions

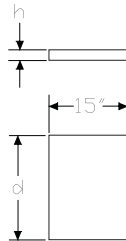

Specification Information

Step 1.

FM893. [A]

Step 2. Height

- 01** 1" high [A]
- 02** 2" high [A]

Step 3. Depth

- 18** 18" deep [A]

Prices for Steps 1-3.

	18
FM893. 01	\$153
02	\$173

Step 4. Fabric

See application chart and textiles list for fabric usage and numbers. First 2 digits of number indicate fabric line; remaining digit(s) indicate fabric color.

Price Category 1	+\$0
Price Category 2	+\$43
Price Category 3	+\$60
Price Category 4	+\$79
Price Category 5	+\$103
Price Category 7	+\$144
Price Category 8	+\$146
Price Category 9	+\$956
Price Category (Geiger) 10	+\$1050
Price Category B	+\$29
Price Category C	+\$39
Price Category D	+\$51
Price Category E	+\$61
Price Category F	+\$79
Price Category G	+\$103
Price Category H	+\$125
Price Category I	+\$147
Price Category J	+\$169
Price Category K	+\$310

Pencil Tray for Box Drawer

FM924.

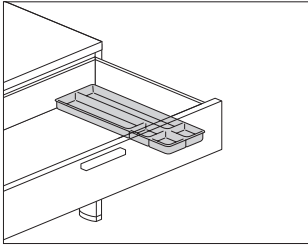

Product Information

Description

This plastic tray provides storage for pencils and other small items in a pedestal or credenza box drawer. Finish is black umber.

Dimensions

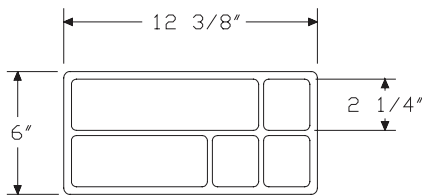
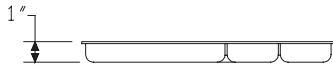

For 15" Wide Drawers

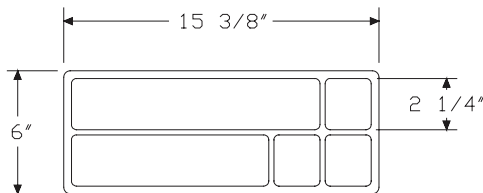

For 30", 36", or 42" Wide Drawers

Specification Information

Step 1.

FM924.

Step 2. Width

P for 15"-wide pedestal drawer

C for 30", 36", or 42"-wide low credenza drawer

Prices for Steps 1-2.

FM924. P	\$26
C	\$31

Step 3. Finish

BU black umber	+\$0
-----------------------	------

Drawer Divider for Box Drawer

FM925.

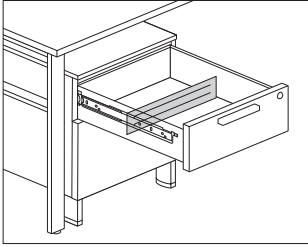

Product Information

Description
This adjustable divider fits into a metal pedestal box drawer to provide separation of items. Finish is black umber.

Dimensions

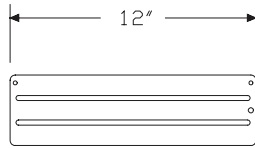
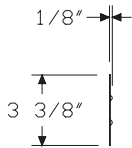

For 15" Wide Drawer

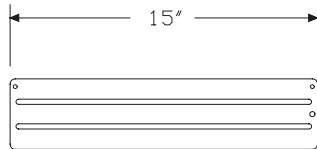

For 18" Wide Drawer

Specification Information

Step 1.
FM925. \$19

Drawer Organizer Kit

FM926.

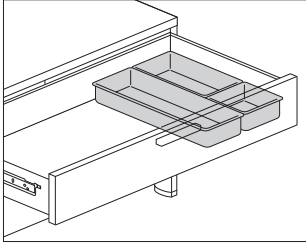

Product Information

Description

This kit has 3 plastic bins that fit into the upper drawer of a metal low credenza to provide organization and small item storage.

Notes

Kit contains 1 each of the following:

- 4⁹/₁₆" x 4⁹/₁₆" container
- 4⁹/₁₆" x 9³/₁₆" container
- 4⁹/₁₆" x 13¹³/₁₆" container

Dimensions

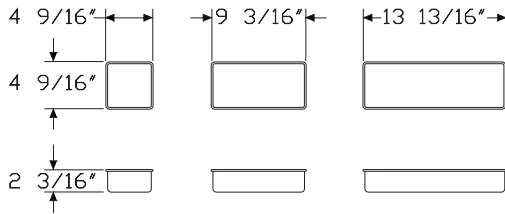

Specification Information

Step 1.

FM926. \$84

Step 2. Finish

91 white +\$0

Stationary Tray for Box Drawer FM927.

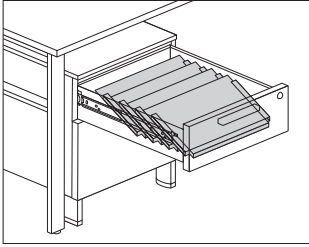

Product Information

Description
This sectioned tray stores envelopes, stationary, and forms in a metal pedestal box drawer. Finish is black umber.

Dimensions

Specification Information

Step 1.
FM927. \$133

Canvas Office Landscape® Metal Case Pedestal Accessories

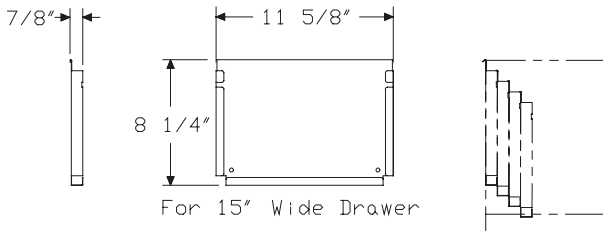

File Compressor

FM928.

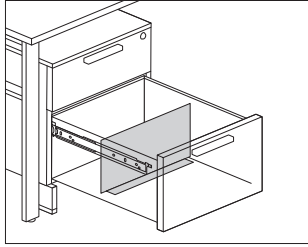

Product Information

Description

This compressor fits into a metal pedestal file drawer. Finish is black umber.

Dimensions

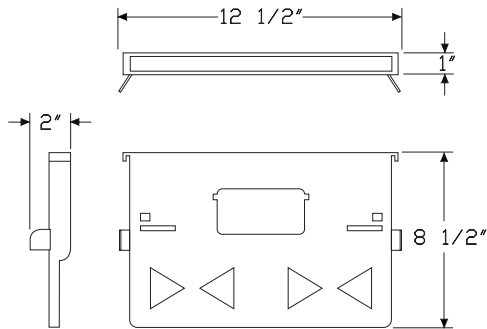

Specification Information

Step 1.

FM928.

\$39

File Drawer Organizer

FM923.

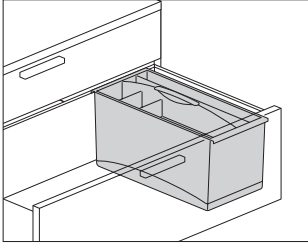

Product Information

Description

This 2-piece plastic organizer fits into any file drawer configured for letter-size filing. It has a removable top tray with sections for storing small items, and a bottom bin that can hold larger items or be divided into 3 sections; 2 vertical dividers included. Finish is black umber.

Dimensions

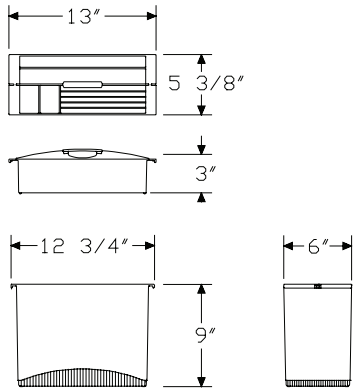

Specification Information

Step 1.

FM923. \$85

Canvas Office Landscape® Metal Case Pedestal Accessories

Metal Vertical Tower, Thin Top

FM90A.
FM90K.

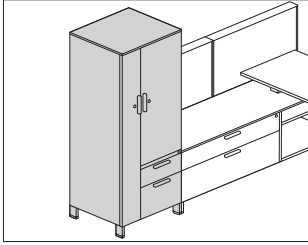

Product Information

Description

This freestanding tower has a 3/8"-high laminate or veneer top and a painted steel case with a painted, laminate, or veneer front. It has a wardrobe on 1 side and a storage case over pedestal drawers on the other side. The tower is available with 4"-high architectural feet or a 2 1/4"-high base with leveling glides. Architectural feet and glides have 1" adjustment range.

The wardrobe includes a coat rod.

The storage case has 1 or 2 adjustable shelves that adjust in 1 1/4" increments.

The pedestal has 1 lock that secures all drawers. It includes a positive interlock system that permits only 1 drawer to open at a time. Drawers have full-extension ball-bearing slides. File drawers accommodate front-to-back filing of letter-size hanging files.

Notes

For additional product options, see Vary Easy Program in Appendices. Arc pull option (A.) conforms to guidelines of Americans with Disabilities Act (ADA).

Grain direction is vertical on veneer and wood-grain laminate fronts.

Dimensional illustrations do not include all possible configurations.

For keyed-alike locks, see Keyed-Alike Information in Appendices.

Dimensions

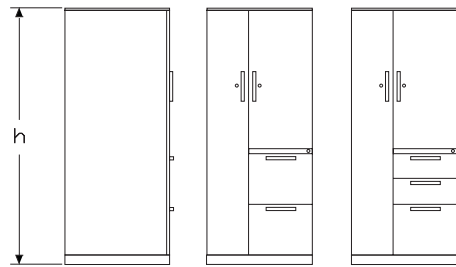
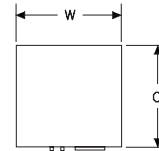

2 1/4" Base File/File Box/Box/File

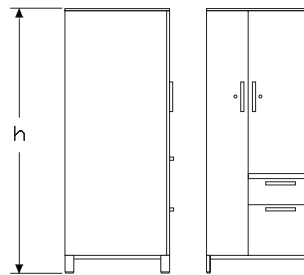

4" Foot Box/File

Metal Vertical Tower, Thin Top

continued

Canvas Office Landscape® Metal Case Towers

Specification Information	
Step 1.	
FM90	<input type="checkbox"/> A
Step 2. Pull Type	
A.	arc pull <input type="checkbox"/> A
K.	bar pull <input type="checkbox"/> A
Step 3. Height	
4	42" high <input type="checkbox"/> A
5	46" high <input type="checkbox"/> A
6	57" high <input type="checkbox"/> A
7	68" high <input type="checkbox"/> A
Step 4. Width	
24	24" wide <input type="checkbox"/> A
Step 5. Depth	
24	24" deep <input type="checkbox"/> A
Step 6. Base/Foot Height	
2	2 1/4"-high base <input type="checkbox"/> A
4	4"-high foot <input type="checkbox"/> A
Step 7. Configuration	
<i>For 2 1/4"-high base (2)</i>	
BR	file/file, wardrobe right <input type="checkbox"/> A
BL	file/file, wardrobe left <input type="checkbox"/> A
CR	box/box/file, wardrobe right <input type="checkbox"/> A
CL	box/box/file, wardrobe left <input type="checkbox"/> A
<i>For 4"-high foot (4)</i>	
HR	box/file, wardrobe right <input type="checkbox"/> A
HL	box/file, wardrobe left <input type="checkbox"/> A
Step 8. Front Material	
P	painted metal front <input type="checkbox"/> A
L	laminate front <input type="checkbox"/> A
W	vener front <input type="checkbox"/> A
Step 9. Top	
3	3/8" laminate top <input type="checkbox"/> A
4	3/8" veneer top <input type="checkbox"/> A
Step 10. Lock	
L	lock <input type="checkbox"/> A

Prices for Steps 1-10.		242BRP3L	242BRP4L	242BRL3L	242BRL4L	242BRW3L	242BRW4L
FM90A. 4	24	\$2809	3044	2957	3191	3451	3686
5	24	\$2921	3155	3075	3309	3568	3803
6	24	\$3033	3268	3191	3426	3686	3921
7	24	\$3144	3380	3309	3545	3803	4039
		242BLP3L	242BLP4L	242BLL3L	242BLL4L	242BLW3L	242BLW4L
FM90A. 4	24	\$2809	3044	2957	3191	3451	3686
5	24	\$2921	3155	3075	3309	3568	3803
6	24	\$3033	3268	3191	3426	3686	3921
7	24	\$3144	3380	3309	3545	3803	4039
		242CRP3L	242CRP4L	242CRL3L	242CRL4L	242CRW3L	242CRW4L
FM90A. 4	24	\$2867	3103	3014	3249	3509	3744
5	24	\$2978	3213	3133	3368	3625	3861
6	24	\$2867	3103	3133	3368	3744	3978
7	24	\$3202	3438	3368	3602	3861	4096
		242CLP3L	242CLP4L	242CLL3L	242CLL4L	242CLW3L	242CLW4L
FM90A. 4	24	\$2867	3103	3014	3249	3509	3744
5	24	\$2978	3213	3133	3368	3625	3861
6	24	\$2867	3103	3133	3368	3744	3978
7	24	\$3202	3438	3368	3602	3861	4096
		244HRP3L	244HRP4L	244HRL3L	244HRL4L	244HRW3L	244HRW4L
FM90A. 4	24	\$2809	3044	2957	3191	3451	3686
5	24	\$2921	3155	3075	3309	3568	3803
6	24	\$3033	3268	3191	3426	3686	3921
7	24	\$3144	3380	3309	3545	3803	4039
		244HLP3L	244HLP4L	244HLL3L	244HLL4L	244HLW3L	244HLW4L
FM90A. 4	24	\$2809	3044	2957	3191	3451	3686
5	24	\$2921	3155	3075	3309	3568	3803
6	24	\$3033	3268	3191	3426	3686	3921
7	24	\$3144	3380	3309	3545	3803	4039
		242BRP3L	242BRP4L	242BRL3L	242BRL4L	242BRW3L	242BRW4L
FM90K. 4	24	\$2809	3044	2957	3191	3451	3686
5	24	\$2921	3155	3075	3309	3568	3803
6	24	\$3033	3268	3191	3426	3686	3921
7	24	\$3144	3380	3309	3545	3803	4039
		242BLP3L	242BLP4L	242BLL3L	242BLL4L	242BLW3L	242BLW4L
FM90K. 4	24	\$2809	3044	2957	3191	3451	3686
5	24	\$2921	3155	3075	3309	3568	3803
6	24	\$3033	3268	3191	3426	3686	3921
7	24	\$3144	3380	3309	3545	3803	4039

Metal Vertical Tower, Thin Top

continued

7 24	\$3144	3380	3309	3545	3803	4039
	242CRP3L	242CRP4L	242CRL3L	242CRL4L	242CRW3L	242CRW4L
FM90K.4 24	\$2867	3103	3014	3249	3509	3744
5 24	\$2978	3213	3133	3368	3625	3861
6 24	\$2867	3103	3133	3368	3744	3978
7 24	\$3202	3438	3368	3602	3861	4096
	242CLP3L	242CLP4L	242CLL3L	242CLL4L	242CLW3L	242CLW4L
FM90K.4 24	\$2867	3103	3014	3249	3509	3744
5 24	\$2978	3213	3133	3368	3625	3861
6 24	\$2867	3103	3133	3368	3744	3978
7 24	\$3202	3438	3368	3602	3861	4096
	244HRP3L	244HRP4L	244HRL3L	244HRL4L	244HRW3L	244HRW4L
FM90K.4 24	\$2809	3044	2957	3191	3451	3686
5 24	\$2921	3155	3075	3309	3568	3803
6 24	\$3033	3268	3191	3426	3686	3921
7 24	\$3144	3380	3309	3545	3803	4039
	244HLP3L	244HLP4L	244HLL3L	244HLL4L	244HLW3L	244HLW4L
FM90K.4 24	\$2809	3044	2957	3191	3451	3686
5 24	\$2921	3155	3075	3309	3568	3803
6 24	\$3033	3268	3191	3426	3686	3921
7 24	\$3144	3380	3309	3545	3803	4039

Step 11. Paint/Steel Type

SS	smooth paint on smooth steel <input type="checkbox"/>	+\$0
XS	textured paint on smooth steel <input type="checkbox"/>	+\$0

Step 12. Surface Finish

Metallic Paint

For smooth paint on smooth steel (SS)

CN	metallic champagne <input type="checkbox"/>	+\$0
EH	metallic bronze <input type="checkbox"/>	+\$0
MS	metallic silver <input type="checkbox"/>	+\$0

For textured paint on smooth steel (XS)

8Q	folkstone grey <input type="checkbox"/>	+\$0
98	studio white <input type="checkbox"/>	+\$0
WL	sandstone <input type="checkbox"/>	+\$0

For textured paint on smooth steel (XS)

91	white <input type="checkbox"/>	+\$0
CL	cool grey neutral <input type="checkbox"/>	+\$0
G1	graphite <input type="checkbox"/>	+\$0
WN	warm grey neutral <input type="checkbox"/>	+\$0

Step 13. Front Finish

Solid-Color Laminate

For laminate front (L)

8Q	folkstone grey <input type="checkbox"/>	+\$0
91	white <input type="checkbox"/>	+\$0
98	studio white	+\$0
CL	cool grey neutral <input type="checkbox"/>	+\$0
LU	soft white <input type="checkbox"/>	+\$0
WL	sandstone <input type="checkbox"/>	+\$0
WN	warm grey neutral <input type="checkbox"/>	+\$0

Linen Laminate

For laminate front (L)

LBM	crisp linen	+\$0
LBN	classic linen	+\$0
LBP	casual linen	+\$0

Mesh Laminate

For laminate front (L)

LBK	pewter mesh	+\$0
LBL	steel mesh	+\$0

Twill Laminate

For laminate front (L)

LBF	neutral twill	+\$0
LBG	sarum twill	+\$0
LBH	earthen twill	+\$0
LBJ	graphite twill	+\$0
LBQ	white twill	+\$0

Metal Vertical Tower, Thin Top

continued

Wood-Grain Laminate

For laminate front (L)

HM	natural maple A	+\$0
HP	light anigre A	+\$0
LBA	clear on ash	+\$0
LBR	phantom ecru	+\$0
LBS	phantom cocoa	+\$0
LBU	medium matte walnut	+\$0
LBV	warm grey teak	+\$0
LBB	oak on ash	+\$0
LBC	walnut on ash	+\$0
LBD	dark brown walnut	+\$0
LBE	medium red walnut	+\$0
76	light brown walnut A	+\$0
HX	aged cherry A	+\$0
HY	walnut on cherry A	+\$0

Wood Veneer

For veneer front (W)

2U	light brown walnut A	+\$0
40	dark brown walnut A	+\$0
ED	aged cherry A	+\$0
EK	medium red walnut A	+\$0
EW	medium matte walnut A	+\$0
ET	clear on ash A	+\$0
EU	oak on ash A	+\$0
EV	walnut on ash A	+\$0
UL	natural maple A	+\$0
UX	walnut on cherry A	+\$0

Step 14. Top Finish

Solid-Color Laminate

For $\frac{3}{8}$ " laminate top (3)

8Q	folkstone grey A	+\$0
91	white A	+\$0
98	studio white	+\$0
CL	cool grey neutral A	+\$0
LU	soft white A	+\$0
WL	sandstone A	+\$0
WN	warm grey neutral A	+\$0

Linen Laminate

For $\frac{3}{8}$ " laminate top (3)

LBM	crisp linen	+\$0
LBN	classic linen	+\$0
LBP	casual linen	+\$0

Mesh Laminate

For $\frac{3}{8}$ " laminate top (3)

LBK	pewter mesh	+\$0
LBL	steel mesh	+\$0

Twill Laminate

For $\frac{3}{8}$ " laminate top (3)

LBF	neutral twill	+\$0
LBG	sarum twill	+\$0
LBH	earthen twill	+\$0
LBJ	graphite twill	+\$0
LBQ	white twill	+\$0

Wood-Grain Laminate

For $\frac{3}{8}$ " laminate top (3)

HM	natural maple A	+\$0
HP	light anigre A	+\$0
LBA	clear on ash	+\$0
LBR	phantom ecru	+\$0
LBS	phantom cocoa	+\$0
LBU	medium matte walnut	+\$0
LBV	warm grey teak	+\$0
LBB	oak on ash	+\$0
LBC	walnut on ash	+\$0
LBD	dark brown walnut	+\$0
LBE	medium red walnut	+\$0
76	light brown walnut A	+\$0
HX	aged cherry A	+\$0
HY	walnut on cherry A	+\$0

Wood Veneer

For $\frac{3}{8}$ " veneer top (4)

2U	light brown walnut A	+\$0
40	dark brown walnut A	+\$0
ED	aged cherry A	+\$0
EK	medium red walnut A	+\$0
EW	medium matte walnut A	+\$0
ET	clear on ash A	+\$0
EU	oak on ash A	+\$0
EV	walnut on ash A	+\$0
UL	natural maple A	+\$0
UX	walnut on cherry A	+\$0

Metal Vertical Tower, Thin Top

continued

Step 15. Base Finish

For 4"-high foot (4)

8Q	folkstone grey <input type="checkbox"/>	+\$0
98	studio white <input type="checkbox"/>	+\$0
WL	sandstone <input type="checkbox"/>	+\$0

Bright Sand Texture Paint

91	white <input type="checkbox"/>	+\$0
CL	cool grey neutral <input type="checkbox"/>	+\$0
G1	graphite <input type="checkbox"/>	+\$0
WN	warm grey neutral <input type="checkbox"/>	+\$0

Metallic Paint

CN	metallic champagne <input type="checkbox"/>	+\$0
EH	metallic bronze <input type="checkbox"/>	+\$0
MS	metallic silver <input type="checkbox"/>	+\$0

Step 16. Pull Finish

For arc pull (A.)

NH	brushed nickel <input type="checkbox"/>	+\$0
NK	black nickel <input type="checkbox"/>	+\$0

For bar pull (K.)

8Q	folkstone grey <input type="checkbox"/>	+\$0
91	white <input type="checkbox"/>	+\$0
98	studio white <input type="checkbox"/>	+\$0
G1	graphite <input type="checkbox"/>	+\$0
WL	sandstone <input type="checkbox"/>	+\$0
CN	metallic champagne <input type="checkbox"/>	+\$0
MS	metallic silver <input type="checkbox"/>	+\$0
79	green apple <input type="checkbox"/>	+\$15
MY3	yellow oxide <input type="checkbox"/>	+\$15
RO	red <input type="checkbox"/>	+\$15
TRQ	turquoise <input type="checkbox"/>	+\$15

Step 17. Lock Option

KA	keyed alike <input type="checkbox"/>	-\$10
KC	keyed differently, chrome <input type="checkbox"/>	+\$0
KD	keyed differently, black <input type="checkbox"/>	+\$0

Metal Vertical Tower, Thin Top Side Facing Bookcase

FM91A.
FM91K.

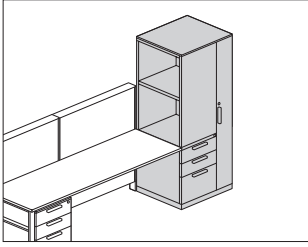

Canvas Office Landscape® Metal Case Towers

Product Information

Description

This freestanding tower has a $\frac{3}{8}$ "-high laminate or veneer top and a steel case with a painted front. It has a wardrobe on 1 side and a side-facing bookcase over pedestal drawers on the other side. The tower has a $2\frac{1}{4}$ "-high base 1" leveling glides.

Actual tower heights are 41 $\frac{1}{2}$ ", 45 $\frac{1}{2}$ ", 56 $\frac{1}{2}$ ", or 67 $\frac{1}{2}$ "; actual width is 23 $\frac{7}{8}$ "; actual depth is 23 $\frac{7}{8}$ ".

The wardrobe includes a coat rod.

The bookcase has 1 or 2 adjustable shelves that adjust in $\frac{1}{4}$ " increments.

The pedestal has 1 lock that secures all drawers. It includes a positive interlock system that permits only 1 drawer to open at a time. Drawers have full-extension ball-bearing slides. File drawers accommodate front-to-back filing of letter-size hanging files.

Notes

For additional product options, see Vary Easy Program in Appendices. Arc pull option (A.) conforms to guidelines of Americans with Disabilities Act (ADA).

Grain direction is vertical on veneer and wood-grain laminate fronts.

Dimensional illustrations do not include all possible configurations.

For keyed-alike locks, see Keyed-Alike Information in Appendices.

Dimensions

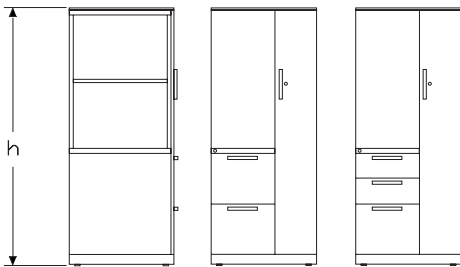
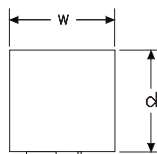

File/File Box/Box/File

Specification Information

Step 1.

FM91 A

Step 2. Pull Type

A. arc pull A

K. bar pull A

Step 3. Height

4 42" high A

5 46" high A

6 57" high A

7 68" high A

Step 4. Width

24 24" wide A

Step 5. Depth

24 24" deep A

Step 6. Base/Foot Height

2 $2\frac{1}{4}$ "-high base A

Step 7. Configuration

BR file/file, wardrobe right A

BL file/file, wardrobe left A

CR box/box/file, wardrobe right A

CL box/box/file, wardrobe left A

Step 8. Front Material

P painted metal front A

Step 9. Top

3 $\frac{3}{8}$ " laminate top A

4 $\frac{3}{8}$ " veneer top A

Step 10. Lock

L lock A

Prices for Steps 1-10.

		242BRP3L	242BRP4L	242BLP3L	242BLP4L	242CRP3L	242CRP4L
FM91A. 4	24	\$2957	3191	2957	3191	3014	3249
5	24	\$3075	3309	3075	3309	3133	3368
6	24	\$3191	3426	3191	3426	3249	3484
7	24	\$3309	3545	3309	3545	3368	3602

Metal Vertical Tower, Thin Top Side Facing Bookcase *continued*

		242CLP3L	242CLP4L
FM91A.4	24	\$3014	3249
5	24	\$3133	3368
6	24	\$3249	3484
7	24	\$3368	3602

		242BRP3L	242BRP4L	242BLP3L	242BLP4L	242CRP3L	242CRP4L
FM91K.4	24	\$2957	3191	2957	3191	3014	3249
5	24	\$3075	3309	3075	3309	3133	3368
6	24	\$3191	3426	3191	3426	3249	3484
7	24	\$3309	3545	3309	3545	3368	3602

		242CLP3L	242CLP4L
FM91K.4	24	\$3014	3249
5	24	\$3133	3368
6	24	\$3249	3484
7	24	\$3368	3602

Step 11. Paint/Steel Type

SS	smooth paint on smooth steel <input type="checkbox"/>	+\$0
XS	textured paint on smooth steel <input type="checkbox"/>	+\$0

Step 12. Surface Finish

Metallic Paint

For smooth paint on smooth steel (SS)

CN	metallic champagne <input type="checkbox"/>	+\$0
EH	metallic bronze <input type="checkbox"/>	+\$0
MS	metallic silver <input type="checkbox"/>	+\$0

For textured paint on smooth steel (XS)

8Q	folkstone grey <input type="checkbox"/>	+\$0
98	studio white <input type="checkbox"/>	+\$0
WL	sandstone <input type="checkbox"/>	+\$0

For textured paint on smooth steel (XS)

91	white <input type="checkbox"/>	+\$0
CL	cool grey neutral <input type="checkbox"/>	+\$0
G1	graphite <input type="checkbox"/>	+\$0
WN	warm grey neutral <input type="checkbox"/>	+\$0

Step 13. Top Finish

Solid-Color Laminate

For 3/8" laminate top (3)

8Q	folkstone grey <input type="checkbox"/>	+\$0
91	white <input type="checkbox"/>	+\$0
98	studio white	+\$0
CL	cool grey neutral <input type="checkbox"/>	+\$0
LU	soft white <input type="checkbox"/>	+\$0
WL	sandstone <input type="checkbox"/>	+\$0
WN	warm grey neutral <input type="checkbox"/>	+\$0

Linen Laminate

For 3/8" laminate top (3)

LBM	crisp linen	+\$0
LBN	classic linen	+\$0
LBP	casual linen	+\$0

Mesh Laminate

For 3/8" laminate top (3)

LBK	pewter mesh	+\$0
LBL	steel mesh	+\$0

Twill Laminate

For 3/8" laminate top (3)

LBF	neutral twill	+\$0
LBG	sarum twill	+\$0
LBH	earthen twill	+\$0
LBJ	graphite twill	+\$0
LBQ	white twill	+\$0

Wood-Grain Laminate

For 3/8" laminate top (3)

76	light brown walnut <input type="checkbox"/>	+\$0
HM	natural maple <input type="checkbox"/>	+\$0
HP	light anigre <input type="checkbox"/>	+\$0
HX	aged cherry <input type="checkbox"/>	+\$0
HY	walnut on cherry <input type="checkbox"/>	+\$0
LBA	clear on ash	+\$0
LBR	phantom ecru	+\$0
LBS	phantom cocoa	+\$0
LBU	medium matte walnut	+\$0
LBV	warm grey teak	+\$0
LBB	oak on ash	+\$0
LBC	walnut on ash	+\$0
LBD	dark brown walnut	+\$0
LBE	medium red walnut	+\$0

Metal Vertical Tower, Thin Top Side Facing Bookcase *continued*

Wood Veneer

For 3/8" veneer top (4)

2U	light brown walnut <input type="checkbox"/> A	+\$0
40	dark brown walnut <input type="checkbox"/> A	+\$0
ED	aged cherry <input type="checkbox"/> A	+\$0
EK	medium red walnut <input type="checkbox"/> A	+\$0
EW	medium matte walnut <input type="checkbox"/> A	+\$0
ET	clear on ash <input type="checkbox"/> A	+\$0
EU	oak on ash <input type="checkbox"/> A	+\$0
EV	walnut on ash <input type="checkbox"/> A	+\$0
UL	natural maple <input type="checkbox"/> A	+\$0
UX	walnut on cherry <input type="checkbox"/> A	+\$0

Step 14. Pull Finish

For arc pull (A.)

NH	brushed nickel <input type="checkbox"/> A	+\$0
NK	black nickel <input type="checkbox"/> A	+\$0

For bar pull (K.)

8Q	folkstone grey	+\$0
91	white	+\$0
98	studio white <input type="checkbox"/> A	+\$0
G1	graphite <input type="checkbox"/> A	+\$0
WL	sandstone <input type="checkbox"/> A	+\$0
CN	metallic champagne <input type="checkbox"/> A	+\$0
MS	metallic silver <input type="checkbox"/> A	+\$0
79	green apple <input type="checkbox"/> A	+\$15
MY3	yellow oxide <input type="checkbox"/> A	+\$15
RO	red <input type="checkbox"/> A	+\$15
TRQ	turquoise <input type="checkbox"/> A	+\$15

Step 15. Lock Option

KA	keyed alike <input type="checkbox"/> A	-\$10
KC	keyed differently, chrome <input type="checkbox"/> A	+\$0
KD	keyed differently, black <input type="checkbox"/> A	+\$0

Canvas Vertical Tower Attachment Bracket FM930.

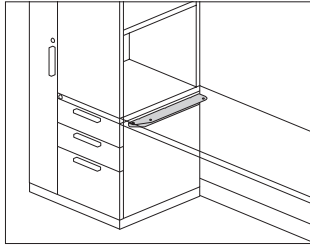

Product Information

Description

This bracket attaches to the side of a Canvas metal vertical storage tower to support 1 end of a 24" deep surface, eliminating the need for a support leg or cantilever. Finish is black. Attachment hardware included.

Notes

Bracket must attach to the pedestal side of storage tower.
Bracket does not provide support for a panel or frame.

Dimensions

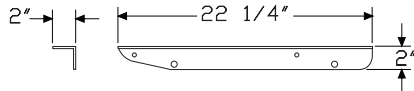

Specification Information

Step 1.

FM930.

\$43

Tu® Storage Tower Attachment Bracket LG692

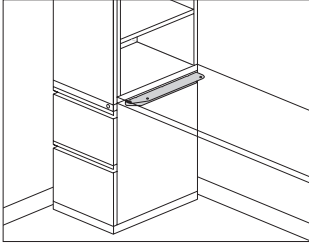

Product Information

Description
 This bracket attaches to the side of a Tu Metal storage tower to support 1 end of a 24" deep surface, eliminating the need for a support leg or cantilever. Finish is black. Attachment hardware included.

Notes

Bracket must attach to the pedestal side of a metal storage tower.
 Bracket does not provide support for a panel or frame.

Dimensions

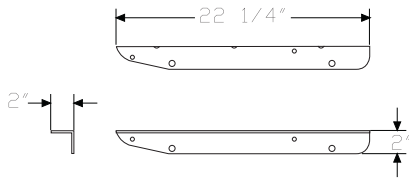

Specification Information

Step 1.
LG692 \$43

Meridian® Vertical Tower Attachment Bracket

MTAB.

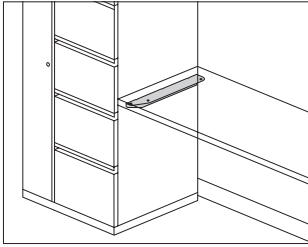

Product Information

Description

This bracket attaches to the side of a Meridian vertical storage tower to support 1 end of a 24" deep surface, eliminating the need for a support leg or cantilever. Finish is black. Attachment hardware included.

Notes

Bracket must attach to the pedestal side of storage tower.
Bracket does not provide support for a panel or frame.

Dimensions

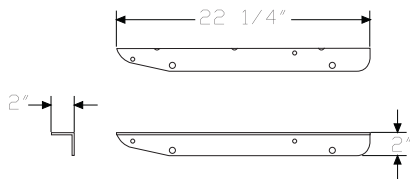

Specification Information

Step 1.

MTAB.

\$41

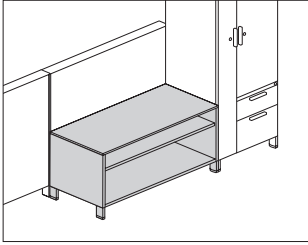

Product Information

Description

This credenza provides open storage and can be used freestanding or attached to a Canvas wall-based frame to support a frame run. It can also be used to support 1 end of a surface. The credenza has a 3/8"-high or 1 1/4"-high laminate or veneer top and a painted steel case. It is available with 4"-high architectural feet, 4"-high sleeveless architectural feet or a 2 1/4"-high base with 1" leveling glides.

Actual credenza widths are 29 7/8", 35 7/8", 41 7/8", 47 3/4", or 59 3/4"; actual depth is 19 7/8".

Notes

For additional product options, see Vary Easy Program in Appendices.

30"-, 36"-, and 42"-wide credenzas have no center divider and include 1 adjustable shelf. 48"- and 60"-wide credenzas have a center divider and include 2 adjustable shelves. Shelves adjust in 1 1/4" increments.

Order optional metal credenza shelf (FM892.) separately.

Credenza with 4"-high foot option (4) and 3/8" thin top can be used to support a Canvas wall-based frame. Order support bracket, low credenza-to-frame (FT292.) separately.

When using credenza to support 1 end of a surface, order 1 of the following products separately:

- Surface support, low credenza, adjustable height (FT299.)
- Surface support, low credenza, fixed height (FT298.)

To cover adjacent credenzas with a single top, specify credenzas with no top option (NT) and order credenza top (FM890.) separately.

1 1/4" top (o6 and o7) is not removable and cannot be used to support a Canvas wall-based frame. The 1 1/4" top will add 5/8" to overall height of unit.

Please note that on the 4" sleeveless architectural foot (5) glides will be more visible.

To provide temporary guest seating on a credenza, order cushion top (FF891.) separately.

Dimensions

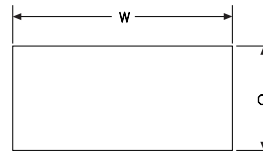

24", 30", 36", 42" Wide

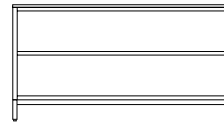

48", 60" Wide

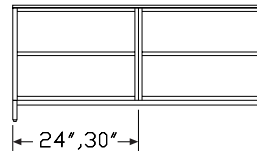

24", 30"

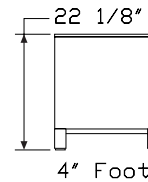

4" Foot

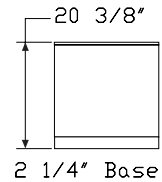

2 1/4" Base

Metal Low Credenza, Open *continued*

Specification Information

Step 1.

FM700.

Step 2. Width

30	30" wide
36	36" wide
42	42" wide
48	48" wide A
60	60" wide A

Step 3. Depth

20	20" deep
-----------	----------

Step 4. Base/Foot Height

2	2 1/4"-high base
4	4"-high foot
5	4" -high foot sleeveless A

Step 5. Top

NT	no top
03	3/8" laminate top
04	3/8" veneer top A
06	1 1/4" laminate top
07	1 1/4" veneer top A

Prices for Steps 1-5.

	2NT	203	204	206	207	4NT
FM700. 30 20	\$1093	1212	1446	1097	1332	1276
36 20	\$1178	1296	1531	1183	1417	1366
42 20	\$1307	1427	1661	1312	1514	1397
48 20	\$1412	1696	2003	1326	1612	1696
60 20	\$1834	1970	2238	1709	1978	2003
	403	404	406	407	5NT	503
FM700. 30 20	\$1401	1655	1279	1532	1213	1341
36 20	\$1493	1747	1370	1501	1306	1432
42 20	\$1514	1748	1400	1635	1339	1457
48 20	\$1866	2173	1601	1908	1629	1800
60 20	\$2136	2407	1877	2147	1938	2071
		504	506	507		
FM700. 30 20		\$1593	1218	1470		
36 20		\$1686	1310	1439		
42 20		\$1692	1344	1578		
48 20		\$2107	1535	1842		
60 20		\$2341	1811	2081		

Step 6. Paint/Steel Type

SS	smooth paint on smooth steel	+\$0
XS	textured paint on smooth steel	+\$0

Step 7. Surface Finish

Metallic Paint

For smooth paint on smooth steel (SS)

CN	metallic champagne	+\$0
EH	metallic bronze	+\$0
MS	metallic silver	+\$0

Sand Texture Paint

For textured paint on smooth steel (XS)

8Q	folkstone grey A	+\$0
98	studio white A	+\$0
WL	sandstone A	+\$0

Bright Sand Texture Paint

For textured paint on smooth steel (XS)

91	white	+\$0
CL	cool grey neutral A	+\$0
G1	graphite A	+\$0
WN	warm grey neutral	+\$0

Step 8. Top Finish

Solid-Color Laminate

For 3/8" laminate top (03) or 1 1/4" laminate top (06)

8Q	folkstone grey A	+\$0
91	white	+\$0
98	studio white	+\$0
CL	cool grey neutral A	+\$0
LU	soft white A	+\$0
WL	sandstone A	+\$0
WN	warm grey neutral	+\$0

Linen Laminate

For 3/8" laminate top (03) or 1 1/4" laminate top (06)

LBM	crisp linen	+\$0
LBN	classic linen	+\$0
LBP	casual linen	+\$0

Mesh Laminate

For 3/8" laminate top (03) or 1 1/4" laminate top (06)

LBK	pewter mesh	+\$0
LBL	steel mesh	+\$0

Metal Low Credenza, Open *continued*

Twill Laminate

For 3/8" laminate top (03) or 1/4" laminate top (06)

LBF	neutral twill	+\$0
LBG	sarum twill	+\$0
LBH	earthen twill	+\$0
LBJ	graphite twill	+\$0
LBQ	white twill	+\$0

Wood-Grain Laminate

For 3/8" laminate top (03) or 1/4" laminate top (06)

HM	natural maple	+\$0
HP	light anigre <input type="checkbox"/>	+\$0
LBA	clear on ash	+\$0
LBR	phantom ecru	+\$0
LBS	phantom cocoa	+\$0
LBU	medium matte walnut	+\$0
LBV	warm grey teak	+\$0
LBB	oak on ash	+\$0
LBC	walnut on ash	+\$0
LBD	dark brown walnut	+\$0
LBE	medium red walnut	+\$0
76	light brown walnut <input type="checkbox"/>	+\$0
HX	aged cherry	+\$0
HY	walnut on cherry <input type="checkbox"/>	+\$0

Wood Veneer

For 3/8" veneer top (04) or 1/4" veneer top (07)

2U	light brown walnut <input type="checkbox"/>	+\$0
40	dark brown walnut <input type="checkbox"/>	+\$0
ED	aged cherry <input type="checkbox"/>	+\$0
EK	medium red walnut <input type="checkbox"/>	+\$0
EW	medium matte walnut <input type="checkbox"/>	+\$0
ET	clear on ash <input type="checkbox"/>	+\$0
EU	oak on ash <input type="checkbox"/>	+\$0
EV	walnut on ash <input type="checkbox"/>	+\$0
UL	natural maple <input type="checkbox"/>	+\$0
UX	walnut on cherry <input type="checkbox"/>	+\$0

Step 9. Base Finish

For 4"-high foot (4) or 4"-high foot sleeveless (5)

8Q	folkstone grey <input type="checkbox"/>	+\$0
98	studio white <input type="checkbox"/>	+\$0
WL	sandstone <input type="checkbox"/>	+\$0
91	white	+\$0
CL	cool grey neutral <input type="checkbox"/>	+\$0
G1	graphite <input type="checkbox"/>	+\$0
WN	warm grey neutral	+\$0

Metallic Paint

CN	metallic champagne	+\$0
EH	metallic bronze	+\$0
MS	metallic silver	+\$0

Metal Low Credenza, with Doors

FM71A.
FM71K.

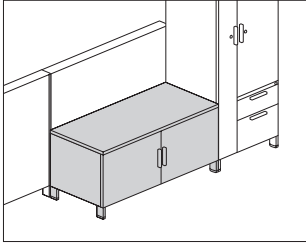

Product Information

Description

This credenza provides enclosed storage and can be used freestanding or attached to a Canvas wall-based frame to support a frame run. It can also be used to support 1 end of a surface. The credenza has a 3/8"-high or 1 1/4"-high laminate or veneer top and a painted steel case. It is available with 4"-high architectural feet, 4"-high sleeveless architectural feet or a 2 1/4"-high base with 1" leveling glides.

Actual credenza widths are 29 7/8", 35 7/8", 41 7/8", 47 3/4", or 59 3/4"; actual depth is 19 7/8".

Notes

For additional product options, see Vary Easy Program in Appendices. Arc pull option (A.) conforms to guidelines of Americans with Disabilities Act (ADA).

Grain direction is vertical on veneer and wood-grain laminate fronts. 30"-, 36"-, and 42"-wide credenzas have no center divider and include 1 adjustable shelf. 48"- and 60"-wide credenzas have a center divider and include 2 adjustable shelves. Shelves adjust in 1 1/4" increments.

Order optional metal credenza shelf (FM892.) separately.

Credenza with 4"-high foot option (4) and 3/8" thin top can be used to support a Canvas wall-based frame. Order support bracket, low credenza-to-frame (FT292.) separately.

When using credenza to support 1 end of a surface, order 1 of the following products separately:

- Surface support, low credenza, adjustable height (FT299.)
- Surface support, low credenza, fixed height (FT298.)

To cover adjacent credenzas with a single top, specify credenzas with no top option (NT) and order credenza top (FM890.) separately.

1 1/4" top (o6 and o7) is not removable and cannot be used to support a Canvas wall-based frame. The 1 1/4" top will add 5/8" to overall height of unit.

Please note that on the 4" sleeveless architectural foot (5) glides will be more visible.

To provide temporary guest seating on a credenza, order cushion top (FF891.) separately.

For keyed-alike locks, see Keyed-Alike Information in Appendices.

Dimensions

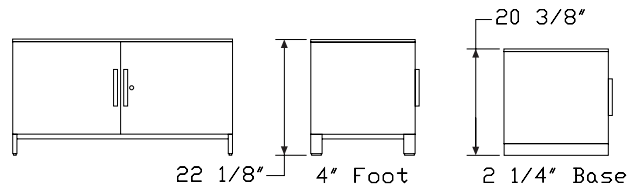
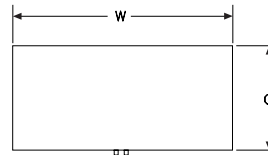

Metal Low Credenza, with Doors

continued

Canvas Office Landscape® Metal Case Credenzas

Specification Information

Step 1.

FM71

Step 2. Pull Type

A. arc pull

K. bar pull

Step 3. Width

30 30" wide

36 36" wide

42 42" wide

Step 4. Depth

20 20" deep

Step 5. Base/Foot Height

2 2 1/4"-high base

4 4"-high foot

5 4"-high foot sleeveless

Step 6. Front Material

P painted metal front

L laminate front

W veneer front

Step 7. Top

For painted metal front (P) or laminate front (L)

NT no top

03 3/8" laminate top

04 3/8" veneer top

06 1 1/4" laminate top

07 1 1/4" veneer top

For veneer front (W)

NT no top

04 3/8" veneer top

07 1 1/4" veneer top

Step 8. Lock

L lock

Prices for Steps 1-8.

	2PNTL	2P03L	2P04L	2P06L	2P07L	2LNTL
FM71A.30 20	\$1295	1421	1670	1301	1550	1440
36 20	\$1389	1506	1742	1392	1628	1543

42 20	\$1584	1701	1937	1587	1823	1759
--------------	--------	------	------	------	------	------

	2L03L	2L04L	2L06L	2L07L	2WNTL	2W04L
--	-------	-------	-------	-------	-------	-------

FM71A.30 20	\$1564	1813	1444	1693	2116	2490
--------------------	--------	------	------	------	------	------

36 20	\$1661	1897	1548	1782	2269	2620
--------------	--------	------	------	------	------	------

42 20	\$1875	2112	1762	1999	2586	2938
--------------	--------	------	------	------	------	------

	2W07L	4PNTL	4P03L	4P04L	4P06L	4P07L
--	-------	-------	-------	-------	-------	-------

FM71A.30 20	\$2368	1371	1496	1744	1375	1623
--------------------	--------	------	------	------	------	------

36 20	\$2506	1512	1633	1876	1517	1760
--------------	--------	------	------	------	------	------

42 20	\$2825	1671	1790	2025	1675	1911
--------------	--------	------	------	------	------	------

	4LNTL	4L03L	4L04L	4L06L	4L07L	4WNTL
--	-------	-------	-------	-------	-------	-------

FM71A.30 20	\$1522	1646	1896	1526	1776	2196
--------------------	--------	------	------	------	------	------

36 20	\$1679	1800	2042	1682	1925	2425
--------------	--------	------	------	------	------	------

42 20	\$1860	1977	2213	1864	2099	2687
--------------	--------	------	------	------	------	------

	4W04L	4W07L	5PNTL	5P03L	5P04L	5P06L
--	-------	-------	-------	-------	-------	-------

FM71A.30 20	\$2571	2452	1311	1434	1684	1314
--------------------	--------	------	------	------	------	------

36 20	\$2789	2672	1454	1574	1817	1458
--------------	--------	------	------	------	------	------

42 20	\$3038	2925	1615	1732	1968	1619
--------------	--------	------	------	------	------	------

	5P07L	5LNTL	5L03L	5L04L	5L06L	5L07L
--	-------	-------	-------	-------	-------	-------

FM71A.30 20	\$1564	1461	1587	1836	1466	1715
--------------------	--------	------	------	------	------	------

36 20	\$1701	1621	1741	1983	1625	1867
--------------	--------	------	------	------	------	------

42 20	\$1854	1803	1920	2156	1807	2042
--------------	--------	------	------	------	------	------

	5WNTL	5W04L	5W07L
--	-------	-------	-------

FM71A.30 20	\$2137	2513	2392
--------------------	--------	------	------

36 20	\$2366	2731	2614
--------------	--------	------	------

42 20	\$2630	2981	2868
--------------	--------	------	------

	2PNTL	2P03L	2P04L	2P06L	2P07L	2LNTL
--	-------	-------	-------	-------	-------	-------

FM71K.30 20	\$1295	1421	1670	1301	1550	1440
--------------------	--------	------	------	------	------	------

36 20	\$1389	1506	1742	1392	1628	1543
--------------	--------	------	------	------	------	------

42 20	\$1584	1701	1937	1587	1823	1759
--------------	--------	------	------	------	------	------

	2L03L	2L04L	2L06L	2L07L	2WNTL	2W04L
--	-------	-------	-------	-------	-------	-------

FM71K.30 20	\$1564	1813	1444	1693	2116	2490
--------------------	--------	------	------	------	------	------

36 20	\$1661	1897	1548	1782	2269	2620
--------------	--------	------	------	------	------	------

42 20	\$1875	2112	1762	1999	2586	2938
--------------	--------	------	------	------	------	------

	2W07L	4PNTL	4P03L	4P04L	4P06L	4P07L
--	-------	-------	-------	-------	-------	-------

FM71K.30 20	\$2368	1371	1496	1744	1375	1623
--------------------	--------	------	------	------	------	------

36 20	\$2506	1512	1633	1876	1517	1760
--------------	--------	------	------	------	------	------

42 20	\$2825	1671	1790	2025	1675	1911
--------------	--------	------	------	------	------	------

Metal Low Credenza, with Doors

continued

	4LN7L	4L03L	4L04L	4L06L	4L07L	4WN7L
FM71K.30 20	\$1522	1646	1896	1526	1776	2196
36 20	\$1679	1800	2042	1682	1925	2425
42 20	\$1860	1977	2213	1864	2099	2687

	4W04L	4W07L	5PNTL	5P03L	5P04L	5P06L
FM71K.30 20	\$2571	2452	1311	1434	1684	1314
36 20	\$2789	2672	1454	1574	1817	1458
42 20	\$3038	2925	1615	1732	1968	1619

	5P07L	5LN7L	5L03L	5L04L	5L06L	5L07L
FM71K.30 20	\$1564	1461	1587	1836	1346	1715
36 20	\$1701	1621	1741	1983	1625	1867
42 20	\$1854	1803	1920	2156	1807	2042

		5WN7L	5W04L	5W07L
FM71K.30 20		\$2137	2513	2392
36 20		\$2366	2731	2614
42 20		\$2630	2981	2868

Step 9. Paint/Steel Type

SS	smooth paint on smooth steel <input type="checkbox"/>	+\$0
XS	textured paint on smooth steel <input type="checkbox"/>	+\$0

Step 10. Surface Finish

Metallic Paint

For smooth paint on smooth steel (SS)

CN	metallic champagne <input type="checkbox"/>	+\$0
EH	metallic bronze <input type="checkbox"/>	+\$0
MS	metallic silver <input type="checkbox"/>	+\$0

Sand Texture Paint

For textured paint on smooth steel (XS)

98	studio white <input type="checkbox"/>	+\$0
8Q	folkstone grey <input type="checkbox"/>	+\$0
WL	sandstone <input type="checkbox"/>	+\$0

Bright Sand Texture Paint

For textured paint on smooth steel (XS)

91	white <input type="checkbox"/>	+\$0
CL	cool grey neutral <input type="checkbox"/>	+\$0
G1	graphite <input type="checkbox"/>	+\$0
WN	warm grey neutral <input type="checkbox"/>	+\$0

Step 11. Front Finish

Solid-Color Laminate

For laminate front (L)

8Q	folkstone grey <input type="checkbox"/>	+\$0
91	white <input type="checkbox"/>	+\$0
98	studio white	+\$0
CL	cool grey neutral <input type="checkbox"/>	+\$0
LU	soft white <input type="checkbox"/>	+\$0
WL	sandstone <input type="checkbox"/>	+\$0
WN	warm grey neutral <input type="checkbox"/>	+\$0

Linon Laminate

For laminate front (L)

LBM	crisp linon	+\$0
LBN	classic linon	+\$0
LBP	casual linon	+\$0

Mesh Laminate

For laminate front (L)

LBK	pewter mesh	+\$0
LBL	steel mesh	+\$0

Twill Laminate

For laminate front (L)

LBF	neutral twill	+\$0
LBG	sarum twill	+\$0
LBH	earthen twill	+\$0
LBJ	graphite twill	+\$0
LBQ	white twill	+\$0

Wood-Grain Laminate

For laminate front (L)

HM	natural maple <input type="checkbox"/>	+\$0
HP	light anigre <input type="checkbox"/>	+\$0
LBA	clear on ash	+\$0
LBR	phantom ecru	+\$0
LBS	phantom cocoa	+\$0
LBU	medium matte walnut	+\$0
LBV	warm grey teak	+\$0
LBB	oak on ash	+\$0
LBC	walnut on ash	+\$0
LBD	dark brown walnut	+\$0
LBE	medium red walnut	+\$0
76	light brown walnut <input type="checkbox"/>	+\$0
HX	aged cherry <input type="checkbox"/>	+\$0
HY	walnut on cherry <input type="checkbox"/>	+\$0

Metal Low Credenza, with Doors

continued

Canvas Office Landscape® Metal Case Credenzas

Wood Veneer

For veneer front (W)

2U	light brown walnut <input type="checkbox"/>	+\$0
40	dark brown walnut <input type="checkbox"/>	+\$0
ED	aged cherry <input type="checkbox"/>	+\$0
EK	medium red walnut <input type="checkbox"/>	+\$0
EW	medium matte walnut <input type="checkbox"/>	+\$0
ET	clear on ash <input type="checkbox"/>	+\$0
EU	oak on ash <input type="checkbox"/>	+\$0
EV	walnut on ash <input type="checkbox"/>	+\$0
UL	natural maple <input type="checkbox"/>	+\$0
UX	walnut on cherry <input type="checkbox"/>	+\$0

Step 12. Top Finish

Solid-Color Laminate

For $\frac{3}{8}$ " laminate top (03) or $1\frac{1}{4}$ " laminate top (06)

8Q	folkstone grey <input type="checkbox"/>	+\$0
91	white <input type="checkbox"/>	+\$0
98	studio white	+\$0
CL	cool grey neutral <input type="checkbox"/>	+\$0
LU	soft white <input type="checkbox"/>	+\$0
WL	sandstone <input type="checkbox"/>	+\$0
WN	warm grey neutral <input type="checkbox"/>	+\$0

Linen Laminate

For $\frac{3}{8}$ " laminate top (03) or $1\frac{1}{4}$ " laminate top (06)

LBM	crisp linen	+\$0
LBN	classic linen	+\$0
LBP	casual linen	+\$0

Mesh Laminate

For $\frac{3}{8}$ " laminate top (03) or $1\frac{1}{4}$ " laminate top (06)

LBK	pewter mesh	+\$0
LBL	steel mesh	+\$0

Twill Laminate

For $\frac{3}{8}$ " laminate top (03) or $1\frac{1}{4}$ " laminate top (06)

LBF	neutral twill	+\$0
LBG	sarum twill	+\$0
LBH	earthen twill	+\$0
LBJ	graphite twill	+\$0
LBQ	white twill	+\$0

Wood-Grain Laminate

For $\frac{3}{8}$ " laminate top (03) or $1\frac{1}{4}$ " laminate top (06)

HM	natural maple <input type="checkbox"/>	+\$0
HP	light anigre <input type="checkbox"/>	+\$0
LBA	clear on ash	+\$0
LBR	phantom ecru	+\$0
LBS	phantom cocoa	+\$0
LBU	medium matte walnut	+\$0
LBV	warm grey teak	+\$0
LBB	oak on ash	+\$0
LBC	walnut on ash	+\$0
LBD	dark brown walnut	+\$0
LBE	medium red walnut	+\$0
76	light brown walnut <input type="checkbox"/>	+\$0
HX	aged cherry <input type="checkbox"/>	+\$0
HY	walnut on cherry <input type="checkbox"/>	+\$0

Wood Veneer

For $\frac{3}{8}$ " veneer top (04) or $1\frac{1}{4}$ " veneer top (07)

2U	light brown walnut <input type="checkbox"/>	+\$0
40	dark brown walnut <input type="checkbox"/>	+\$0
ED	aged cherry <input type="checkbox"/>	+\$0
EK	medium red walnut <input type="checkbox"/>	+\$0
EW	medium matte walnut <input type="checkbox"/>	+\$0
ET	clear on ash <input type="checkbox"/>	+\$0
EU	oak on ash <input type="checkbox"/>	+\$0
EV	walnut on ash <input type="checkbox"/>	+\$0
UL	natural maple <input type="checkbox"/>	+\$0
UX	walnut on cherry <input type="checkbox"/>	+\$0

Step 13. Base Finish

For 4"-high foot (4) or 4"-high foot sleeveless (5)

8Q	folkstone grey <input type="checkbox"/>	+\$0
98	studio white <input type="checkbox"/>	+\$0
WL	sandstone <input type="checkbox"/>	+\$0
91	white <input type="checkbox"/>	+\$0
CL	cool grey neutral <input type="checkbox"/>	+\$0
G1	graphite <input type="checkbox"/>	+\$0
WN	warm grey neutral <input type="checkbox"/>	+\$0

Metallic Paint

CN	metallic champagne <input type="checkbox"/>	+\$0
EH	metallic bronze <input type="checkbox"/>	+\$0
MS	metallic silver <input type="checkbox"/>	+\$0

Metal Low Credenza, with Doors

continued

Step 14. Pull Finish

For arc pull (A.)

NH	brushed nickel <input type="checkbox"/> A	+\$0
NK	black nickel <input type="checkbox"/> A	+\$0

For bar pull (K.)

8Q	folkstone grey	+\$0
91	white	+\$0
98	studio white <input type="checkbox"/> A	+\$0
G1	graphite <input type="checkbox"/> A	+\$0
WL	sandstone <input type="checkbox"/> A	+\$0
CN	metallic champagne <input type="checkbox"/> A	+\$0
MS	metallic silver <input type="checkbox"/> A	+\$0
79	green apple <input type="checkbox"/> A	+\$15
MY3	yellow oxide <input type="checkbox"/> A	+\$15
RO	red <input type="checkbox"/> A	+\$15
TRQ	turquoise <input type="checkbox"/> A	+\$15

Step 15. Lock Option

KA	keyed alike <input type="checkbox"/> A	-\$10
KC	keyed differently, chrome <input type="checkbox"/> A	+\$0
KD	keyed differently, black <input type="checkbox"/> A	+\$0

Metal Low Credenza, with Drawers

FM72A.
FM72K.

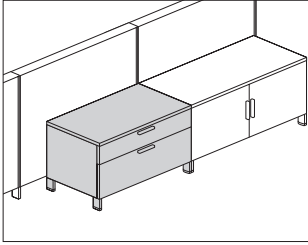

Product Information

Description

This credenza provides enclosed filing and storage and can be used freestanding or attached to a Canvas wall-based frame to support a frame run. It has a $\frac{3}{8}$ "-high or $1\frac{1}{4}$ "-high laminate or veneer top and a painted steel case. It is available with 4"-high architectural feet, 4"-high sleeveless architectural feet or a $2\frac{1}{4}$ "-high base with 1" leveling glides. The credenza has a positive interlock system that permits only 1 drawer to open at a time. Drawers have full-extension ball-bearing slides. The file drawer accommodates front-to-back filing of letter-, legal, and A4-size hanging files.

Actual credenza widths are $29\frac{7}{8}$ ", $35\frac{7}{8}$ ", $41\frac{7}{8}$ ", $59\frac{3}{4}$ " or $71\frac{3}{4}$ "; actual depth is $19\frac{7}{8}$ ".

Notes

For additional product options, see Vary Easy Program in Appendices. Arc pull option (A.) conforms to guidelines of Americans with Disabilities Act (ADA).

File drawers are standard with side-to-side hardware. Order front-to-back rail (FM920.) separately.

Counterweight option (CB) must be specified when a file is not ganged or anchored.

Grain direction is vertical on veneer and wood-grain laminate fronts.

30", 36", and 42"-wide credenzas have 1 box drawer and 1 file drawer.

60"-and 72"-wide credenzas have 2 box drawers and 2 file drawers.

Credenza with 4"-high foot option (4) and $\frac{3}{8}$ " thin top can be used to support a Canvas wall-based frame. Order support bracket, low credenza-to-frame (FT292.) separately.

To cover adjacent credenzas with a single top, specify credenzas with no top option (NT) and order credenza top (FM890.) separately.

$1\frac{1}{4}$ " top (06 and 07) is not removable and cannot be used to support a Canvas wall-based frame. The $1\frac{1}{4}$ " top will add $\frac{5}{8}$ " to overall height of unit.

Please note that on the 4" sleeveless architectural foot (5) glides will be more visible.

To provide temporary guest seating on a credenza, order cushion top (FF891.) separately.

For keyed-alike locks, see Keyed-Alike Information in Appendices.

Dimensions

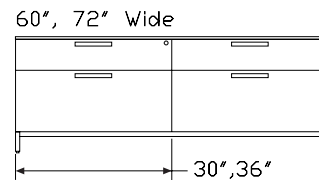
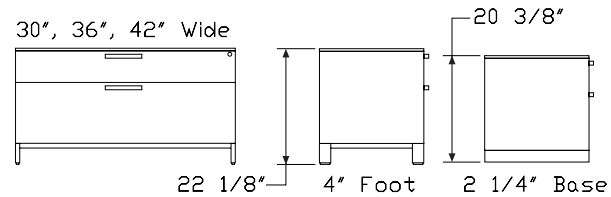
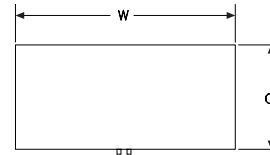

Metal Low Credenza, with Drawers *continued*

Specification Information	
Step 1.	
FM72	
Step 2. Pull Type	
A.	arc pull
K.	bar pull
Step 3. Width	
30	30" wide
36	36" wide
42	42" wide
60	60" wide
72	72" wide
Step 4. Depth	
20	20" deep
Step 5. Base/Foot Height	
2	2 1/4"-high base
4	4"-high foot
5	4" -high foot sleeveless <input type="checkbox"/> A
Step 6. Configuration	
BF	box/file
Step 7. Front Material	
P	painted metal front
L	laminate front
W	vener front <input type="checkbox"/> A
Step 8. Top	
<i>For painted metal front (P) or laminate front (L)</i>	
NT	no top
03	3/8" laminate top
04	3/8" veneer top <input type="checkbox"/> A
06	1 1/4" laminate top
07	1 1/4" veneer top <input type="checkbox"/> A
<i>For veneer front (W)</i>	
NT	no top
04	3/8" veneer top <input type="checkbox"/> A
07	1 1/4" veneer top <input type="checkbox"/> A
Step 9. Lock	
L	lock

Prices for Steps 1-9.						
	2BFPNTL	2BFP03L	2BFP04L	2BFP06L	2BFP07L	2BFLNTL
FM72A.30 20	\$1495	1612	1847	1498	1733	1601
36 20	\$1671	1790	2025	1675	1798	1777
42 20	\$1847	1966	2202	1852	2075	1954
60 20	\$3006	3123	3358	2895	3132	3218
72 20	\$3351	3470	3705	3242	3478	3563
	2BFL03L	2BFL04L	2BFL06L	2BFL07L	2BFWNTL	2BFW04L
FM72A.30 20	\$1720	1954	1605	1841	1962	2316
36 20	\$1896	2130	1781	2016	2285	2639
42 20	\$2071	2308	1957	2308	2655	3008
60 20	\$3336	3570	3108	3344	4130	4482
72 20	\$3682	3917	3454	3689	4580	4932
	2BFW07L	4BFPNTL	4BFP03L	4BFP04L	4BFP06L	4BFP07L
FM72A.30 20	\$2202	1584	1701	1960	1587	1846
36 20	\$2526	1760	1876	2113	1763	2000
42 20	\$2894	1937	2055	2289	1941	2176
60 20	\$4254	3151	3270	3507	3042	3279
72 20	\$4705	3497	3617	3852	3389	3624
	4BFLNTL	4BFL03L	4BFL04L	4BFL06L	4BFL07L	4BFWNTL
FM72A.30 20	\$1690	1807	2042	1693	1928	2051
36 20	\$1866	1982	2218	1869	2105	2375
42 20	\$2042	2160	2395	2046	2282	2744
60 20	\$3364	3482	3717	3254	3490	4347
72 20	\$3711	3827	4063	3600	3835	4726
	4BFW04L	4BFW07L	5BFPNTL	5BFP03L	5BFP04L	5BFP06L
FM72A.30 20	\$2402	2289	1527	1644	1903	1530
36 20	\$2726	2613	1703	1819	2056	1706
42 20	\$3096	2982	1880	1999	2233	1884
60 20	\$4629	4402	3095	3213	3450	2985
72 20	\$5077	4851	3441	3560	3795	3333
	5BFP07L	5BFLNTL	5BFL03L	5BFL04L	5BFL06L	5BFL07L
FM72A.30 20	\$1790	1633	1749	1985	1636	1871
36 20	\$1942	1809	1926	2161	1812	2047
42 20	\$2119	1985	2104	2339	1989	2225
60 20	\$3222	3307	3425	3660	3198	3433
72 20	\$3567	3654	3770	4006	3544	3779
				5BFWNTL	5BFW04L	5BFW07L
FM72A.30 20				\$1994	2346	2233
36 20				\$2318	2669	2556
42 20				\$2688	3039	2926

Canvas Office Landscape® Metal Case Credenzas

Metal Low Credenza, with Drawers *continued*

Canvas Office Landscape® Metal Case Credenzas

60 20	\$4290	4573	4345
72 20	\$4669	5021	4794

	2BFPNTL	2BFP03L	2BFP04L	2BFP06L	2BFP07L	2BFLNTL
FM72K.30 20	\$1495	1612	1847	1498	1733	1601
36 20	\$1671	1790	2025	1675	1798	1777
42 20	\$1847	1966	2202	1852	2075	1954
60 20	\$3006	3123	3358	2895	3132	3218
72 20	\$3351	3470	3705	3242	3478	3563

	2BFL03L	2BFL04L	2BFL06L	2BFL07L	2BFWNTL	2BFW04L
FM72K.30 20	\$1720	1954	1605	1841	1962	2316
36 20	\$1896	2130	1781	2016	2285	2639
42 20	\$2071	2308	1957	2308	2655	3008
60 20	\$3336	3570	3108	3344	4130	4482
72 20	\$3682	3917	3454	3689	4580	4932

	2BFW07L	4BFPNTL	4BFP03L	4BFP04L	4BFP06L	4BFP07L
FM72K.30 20	\$2202	1584	1701	1960	1587	1846
36 20	\$2526	1760	1876	2113	1763	2000
42 20	\$2894	1937	2055	2289	1941	2176
60 20	\$4254	3151	3270	3507	3042	3279
72 20	\$4705	3497	3617	3852	3389	3624

	4BFLNTL	4BFL03L	4BFL04L	4BFL06L	4BFL07L	4BFWNTL
FM72K.30 20	\$1690	1807	2042	1693	1928	2051
36 20	\$1866	1982	2218	1869	2105	2375
42 20	\$2042	2160	2395	2046	2282	2744
60 20	\$3364	3482	3717	3254	3490	4347
72 20	\$3711	3827	4063	3600	3835	4726

	4BFW04L	4BFW07L	5BFPNTL	5BFP03L	5BFP04L	5BFP06L
FM72K.30 20	\$2402	2289	1527	1644	1903	1530
36 20	\$2726	2613	1703	1819	2056	1706
42 20	\$3096	2982	1880	1999	2233	1884
60 20	\$4629	4402	3095	3213	3450	2985
72 20	\$5077	4851	3441	3560	3795	3333

	5BFP07L	5BFLNTL	5BFL03L	5BFL04L	5BFL06L	5BFL07L
FM72K.30 20	\$1790	1633	1749	1985	1636	1871
36 20	\$1942	1809	1926	2161	1812	2047
42 20	\$2119	1985	2104	2339	1989	2225
60 20	\$3222	3307	3425	3660	3198	3433
72 20	\$3567	3654	3770	4006	3544	3779

	5BFWNTL	5BFW04L	5BFW07L
FM72K.30 20	\$1994	2346	2233

36 20	\$2318	2669	2556
42 20	\$2688	3039	2926
60 20	\$4290	4573	4345
72 20	\$4669	5021	4794

Step 10. Paint/Steel Type

SS	smooth paint on smooth steel	+\$0
XS	textured paint on smooth steel	+\$0

Step 11. Surface Finish

Metallic Paint

For smooth paint on smooth steel (SS)

CN	metallic champagne	+\$0
EH	metallic bronze	+\$0
MS	metallic silver	+\$0

Sand Texture Paint

For textured paint on smooth steel (XS)

98	studio white A	+\$0
8Q	folkstone grey A	+\$0
WL	sandstone A	+\$0

Bright Sand Texture Paint

For textured paint on smooth steel (XS)

91	white	+\$0
CL	cool grey neutral A	+\$0
G1	graphite A	+\$0
WN	warm grey neutral	+\$0

Step 12. Front Finish

Solid-Color Laminate

For laminate front (L)

8Q	folkstone grey A	+\$0
91	white	+\$0
98	studio white	+\$0
CL	cool grey neutral A	+\$0
LU	soft white A	+\$0
WL	sandstone A	+\$0
WN	warm grey neutral	+\$0

Linen Laminate

For laminate front (L)

LBM	crisp linen	+\$0
LBN	classic linen	+\$0
LBP	casual linen	+\$0

Metal Low Credenza, with Drawers *continued*

Mesh Laminate

For laminate front (L)

LBK	pewter mesh	+\$0
LBL	steel mesh	+\$0

Twill Laminate

For laminate front (L)

LBF	neutral twill	+\$0
LBG	sarum twill	+\$0
LBH	earthen twill	+\$0
LBJ	graphite twill	+\$0
LBQ	white twill	+\$0

Wood-Grain Laminate

For laminate front (L)

HM	natural maple	+\$0
HP	light anigre A	+\$0
LBA	clear on ash	+\$0
LBR	phantom ecru	+\$0
LBS	phantom cocoa	+\$0
LBU	medium matte walnut	+\$0
LBV	warm grey teak	+\$0
LBB	oak on ash	+\$0
LBC	walnut on ash	+\$0
LBD	dark brown walnut	+\$0
LBE	medium red walnut	+\$0
76	light brown walnut A	+\$0
HX	aged cherry	+\$0
HY	walnut on cherry A	+\$0

Wood Veneer

For veneer front (W)

2U	light brown walnut A	+\$0
40	dark brown walnut A	+\$0
ED	aged cherry A	+\$0
EK	medium red walnut A	+\$0
EW	medium matte walnut A	+\$0
ET	clear on ash A	+\$0
EU	oak on ash A	+\$0
EV	walnut on ash A	+\$0
UL	natural maple A	+\$0
UX	walnut on cherry A	+\$0

Step 13. Top Finish

Solid-Color Laminate

For 3/8" laminate top (o3) or 1 1/4" laminate top (o6)

8Q	folkstone grey A	+\$0
91	white	+\$0
98	studio white	+\$0
CL	cool grey neutral A	+\$0
LU	soft white A	+\$0
WL	sandstone A	+\$0
WN	warm grey neutral	+\$0

Linen Laminate

For 3/8" laminate top (o3) or 1 1/4" laminate top (o6)

LBM	crisp linen	+\$0
LBN	classic linen	+\$0
LBP	casual linen	+\$0

Mesh Laminate

For 3/8" laminate top (o3) or 1 1/4" laminate top (o6)

LBK	pewter mesh	+\$0
LBL	steel mesh	+\$0

Twill Laminate

For 3/8" laminate top (o3) or 1 1/4" laminate top (o6)

LBF	neutral twill	+\$0
LBG	sarum twill	+\$0
LBH	earthen twill	+\$0
LBJ	graphite twill	+\$0
LBQ	white twill	+\$0

Wood-Grain Laminate

For 3/8" laminate top (o3) or 1 1/4" laminate top (o6)

HM	natural maple	+\$0
HP	light anigre A	+\$0
LBA	clear on ash	+\$0
LBR	phantom ecru	+\$0
LBS	phantom cocoa	+\$0
LBU	medium matte walnut	+\$0
LBV	warm grey teak	+\$0
LBB	oak on ash	+\$0
LBC	walnut on ash	+\$0
LBD	dark brown walnut	+\$0
LBE	medium red walnut	+\$0
76	light brown walnut A	+\$0
HX	aged cherry	+\$0
HY	walnut on cherry A	+\$0

Metal Low Credenza, with Drawers *continued*

Wood Veneer		
<i>For 3/8" veneer top (04) or 1/4" veneer top (07)</i>		
2U	light brown walnut <input type="checkbox"/> A	+\$0
40	dark brown walnut <input type="checkbox"/> A	+\$0
ED	aged cherry <input type="checkbox"/> A	+\$0
EK	medium red walnut <input type="checkbox"/> A	+\$0
EW	medium matte walnut <input type="checkbox"/> A	+\$0
ET	clear on ash <input type="checkbox"/> A	+\$0
EU	oak on ash <input type="checkbox"/> A	+\$0
EV	walnut on ash <input type="checkbox"/> A	+\$0
UL	natural maple <input type="checkbox"/> A	+\$0
UX	walnut on cherry <input type="checkbox"/> A	+\$0

Step 14. Base Finish		
<i>For 4"-high foot (4) or 4"-high foot sleeveless (5)</i>		
8Q	folkstone grey <input type="checkbox"/> A	+\$0
98	studio white <input type="checkbox"/> A	+\$0
WL	sandstone <input type="checkbox"/> A	+\$0
91	white	+\$0
CL	cool grey neutral <input type="checkbox"/> A	+\$0
G1	graphite <input type="checkbox"/> A	+\$0
WN	warm grey neutral	+\$0

Metallic Paint		
CN	metallic champagne	+\$0
EH	metallic bronze	+\$0
MS	metallic silver	+\$0

Step 15. Pull Finish		
<i>For arc pull (A.)</i>		
NH	brushed nickel	+\$0
NK	black nickel <input type="checkbox"/> A	+\$0

<i>For bar pull (K.)</i>		
8Q	folkstone grey	+\$0
91	white	+\$0
98	studio white	+\$0
G1	graphite <input type="checkbox"/> A	+\$0
WL	sandstone <input type="checkbox"/> A	+\$0
CN	metallic champagne <input type="checkbox"/> A	+\$0
MS	metallic silver	+\$0
79	green apple <input type="checkbox"/> A	+\$15
MY3	yellow oxide <input type="checkbox"/> A	+\$15
RO	red <input type="checkbox"/> A	+\$15
TRQ	turquoise <input type="checkbox"/> A	+\$15

Step 16. Counterweight		
NO	no counterweight	+\$0
CB	counterweight	+\$115

Step 17. Lock Option		
KA	keyed alike	-\$10
KC	keyed differently, chrome	+\$0
KD	keyed differently, black	+\$0

Metal Low Credenza, Open with Drawers

FM73A.
FM73K.

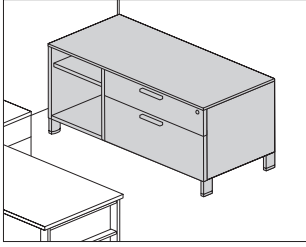

Product Information

Description

This credenza provides drawer storage on 1 side with open storage on the other side. It can be used freestanding or attached to a Canvas wall-based frame to support a frame run. The credenza can also be used to support 1 end of a surface. It has a 3/8"-high or 1 1/4"-high laminate or veneer top and a painted steel case. It is available with 4"-high architectural feet, 4"-high sleeveless architectural feet or a 2 1/4"-high base with 1" leveling glides. The credenza has a positive interlock system that permits only 1 drawer to open at a time. Drawers have full-extension ball-bearing slides. The file drawer accommodates front-to-back filing of letter-, legal, and A4-size hanging files.

Actual credenza widths are 47 7/8", 59 7/8" or 71 7/8"; actual depth is 19 7/8".

Notes

For additional product options, see Vary Easy Program® in Appendices. Arc pull option (A) conforms to guidelines of Americans with Disabilities Act (ADA).

File drawers are standard with side-to-side hardware. Order front-to-back rail (FM920.) separately.

Counterweight option (CB) must be specified when a file is not ganged or anchored.

Grain direction is vertical on veneer and wood-grain laminate fronts.

Open side of credenza includes 1 adjustable shelf that adjusts in 1/4" increments.

Order optional metal credenza shelf (FM892.) separately.

Credenza with 4"-high foot option (4) and 3/8" thin top can be used to support a Canvas wall-based frame. Order support bracket, low credenza-to-frame (FT292.) separately.

When using credenza to support 1 end of a surface, order 1 of the following products separately:

- Surface support, low credenza, adjustable height (FT299.)
- Surface support, low credenza, fixed height (FT298.)

To cover adjacent credenzas with a single top, specify credenzas with no top option (NT) and order credenza top (FM890.) separately.

1 1/4" top (06 and 07) is not removable and cannot be used to support a Canvas wall-based frame. The 1 1/4" top will add 5/8" to overall height of unit.

Please note that on the 4" sleeveless architectural foot (5) glides will be more visible.

To provide temporary guest seating on a credenza, order cushion top (FF891.) separately.

For keyed-alike locks, see Keyed-Alike Information in Appendices.

Dimensions

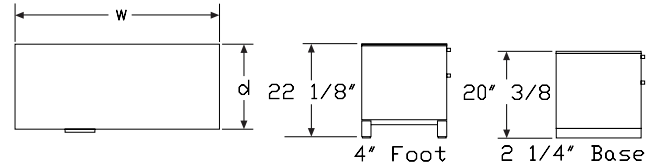

48" Wide

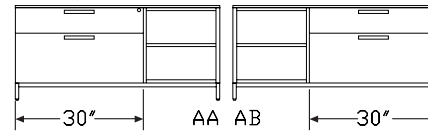

60" Wide

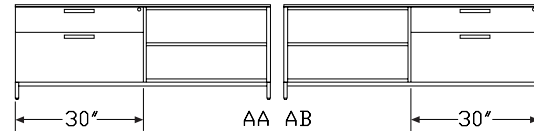

66" Wide

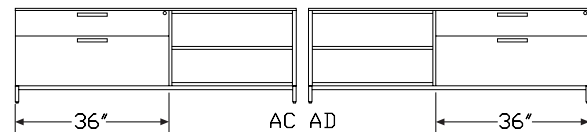

72" Wide

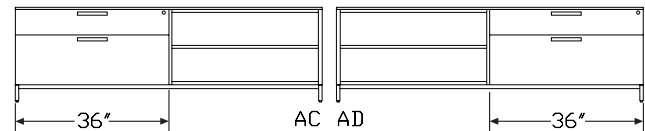

Metal Low Credenza, Open with Drawers *continued*

Specification Information

Step 1.

FM73

Step 2. Pull Type

- A.** arc pull
- K.** bar pull

Step 3. Width

- 48** 48" wide
- 60** 60" wide
- 66** 66" wide
- 72** 72" wide

Step 4. Depth

- 20** 20" deep

Step 5. Base/Foot Height

- 2** 2 1/4"-high base
- 4** 4"-high foot
- 5** 4" -high foot sleeveless

Step 6. Configuration

For 48" wide (48)

- AA** 30" box/file left, open right
- AB** open left, 30" box/file right

For 60" wide (60)

- AA** 30" box/file left, open right
- AB** open left, 30" box/file right
- AC** 36" box/file left, open right
- AD** open left, 36" box/file right

For 66" wide (66) or 72" wide (72)

- AC** 36" box/file left, open right
- AD** open left, 36" box/file right
- AE** 42" box/file left, open right
- AF** open left, 42" box/file right

Step 7. Front Material

- P** painted metal front
- L** laminate front
- W** veneer front

Step 8. Top

For painted metal front (P) or laminate front (L)

- NT** no top
- 03** 3/8" laminate top
- 04** 3/8" veneer top
- 06** 1 1/4" laminate top
- 07** 1 1/4" veneer top

For veneer front (W)

- NT** no top
- 04** 3/8" veneer top
- 07** 1 1/4" veneer top

Step 9. Lock

- L** lock

Prices for Steps 1-9.

	2AAPNTL	2AAP03L	2AAP04L	2AAP06L	2AAP07L	2AALNTL
FM73A. 48 20	\$2381	2498	2734	2272	2506	2546
60 20	\$2598	2715	2947	2488	2720	2775

	2AAL03L	2AAL04L	2AAL06L	2AAL07L	2AAWNTL	2AAW04L
FM73A. 48 20	\$2663	2899	2436	2670	3135	3487
60 20	\$2893	3071	2665	2843	3455	3808

	2AAW07L	2ABPNTL	2ABP03L	2ABP04L	2ABP06L	2ABP07L
FM73A. 48 20	\$3259	2381	2498	2734	2272	2506
60 20	\$3581	2598	2715	2950	2488	2720

	2ABLNTL	2ABL03L	2ABL04L	2ABL06L	2ABL07L	2ABWNTL
FM73A. 48 20	\$2546	2663	2899	2436	2670	3135
60 20	\$2775	2893	3071	2665	2843	3455

	2ABW04L	2ABW07L	2ACPNTL	2ACP03L	2ACP04L	2ACP06L
FM73A. 48 20	\$3487	3259	—	—	—	—
60 20	\$3808	3581	2667	2784	3021	2557
66 20	—	—	\$2700	2818	3052	2591
72 20	—	—	\$2743	2860	3094	2633

	2ACP07L	2ACLNTL	2ACLO3L	2ACLO4L	2ACLO6L	2ACLO7L
FM73A. 60 20	\$2795	2864	2980	3216	2754	2989
66 20	\$2825	2884	3004	3239	2775	3012
72 20	\$2867	2931	3047	3284	2821	3055

	2ACWNTL	2ACW04L	2ACW07L	2AEPNTL	2AEP03L	2AEP04L
FM73A. 60 20	\$3550	3904	3677	—	—	—

Metal Low Credenza, Open with Drawers *continued*

66 20	\$3672	4025	3797	2803	2920	3154	
72 20	\$3775	4129	3901	2847	2965	3199	
		2AEP06L	2AEP07L	2AELN1L	2AEL03L	2AEL04L	2AEL06L
FM73A.66 20	\$2693	2927	2992	3111	3346	2882	
72 20	\$2738	2972	3039	3156	3511	2929	
		2AEL07L	2AEWNTL	2AEW04L	2AEW07L	2ADPNTL	2ADP03L
FM73A.60 20	—	—	—	—	\$2667	2784	
66 20	\$3119	3793	4145	3919	2700	2818	
72 20	\$3284	3899	4251	4025	2743	2860	
		2ADP04L	2ADP06L	2ADP07L	2ADLNTL	2ADL03L	2ADL04L
FM73A.60 20	\$3021	2557	2795	2864	2980	3216	
66 20	\$3052	2591	2825	2884	3004	3239	
72 20	\$3094	2633	2867	2931	3047	3284	
		2ADL06L	2ADL07L	2ADWNTL	2ADW04L	2ADW07L	2AFPNTL
FM73A.60 20	\$2754	2989	3550	3904	3677	—	
66 20	\$2775	3012	3672	4025	3797	2803	
72 20	\$2821	3055	3775	4129	3901	2847	
		2AFP03L	2AFP04L	2AFP06L	2AFP07L	2AFLN1L	2AFL03L
FM73A.66 20	\$2920	3154	2693	2927	2992	3111	
72 20	\$2965	3199	2738	2972	3039	3156	
		2AFL04L	2AFL06L	2AFL07L	2AFWNTL	2AFW04L	2AFW07L
FM73A.66 20	\$3346	2882	3119	3793	4145	3919	
72 20	\$3393	2929	3284	3899	4251	4025	
		4AAPNTL	4AAP03L	4AAP04L	4AAP06L	4AAP07L	4AALN1L
FM73A.48 20	\$2529	2646	2880	2419	2654	2694	
60 20	\$2745	2863	3097	2636	2870	2923	
		4AAL03L	4AAL04L	4AAL06L	4AAL07L	4AAWNTL	4AAW04L
FM73A.48 20	\$2810	3045	2584	2819	3281	3634	
60 20	\$3040	3277	2813	3049	3602	3956	
		4AAW07L	4ABPNTL	4ABP03L	4ABP04L	4ABP06L	4ABP07L
FM73A.48 20	\$3407	2529	2646	2880	2419	2654	
60 20	\$3728	2745	2863	3097	2636	2870	
		4ABLNTL	4ABL03L	4ABL04L	4ABL06L	4ABL07L	4ABWNTL
FM73A.48 20	\$2646	2810	3045	2584	2819	3281	
60 20	\$2923	3040	3277	2813	3049	3602	

		4ABW04L	4ABW07L	4ACPNTL	4ACP03L	4ACP04L	4ACP06L
FM73A.48 20	\$3634	3407	—	—	—	—	—
60 20	\$3956	3728	2814	2933	3169	2706	
66 20	—	—	\$2844	2964	3198	2737	
72 20	—	—	\$2888	3007	3242	2778	
		4ACP07L	4ACLN1L	4ACL03L	4ACL04L	4ACL06L	4ACL07L
FM73A.60 20	\$2940	3011	3128	3362	2901	3136	
66 20	\$2971	3031	3147	3383	2921	3155	
72 20	\$3015	3078	3195	3429	2968	3202	
		4ACWNTL	4ACW04L	4ACW07L	4AEPNTL	4AEP03L	4AEP04L
FM73A.60 20	\$3696	4051	3823	—	—	—	
66 20	\$3851	4202	3976	2945	3066	3299	
72 20	\$3922	4276	4049	2992	3111	3346	
		4AEP06L	4AEP07L	4AELN1L	4AEL03L	4AEL04L	4AEL06L
FM73A.66 20	\$2836	3072	3138	3254	3490	3028	
72 20	\$2882	3119	3187	3305	3541	3078	
		4AEL07L	4AEWNTL	4AEW04L	4AEW07L	4ADPNTL	4ADP03L
FM73A.60 20	—	—	—	—	\$2814	2933	
66 20	\$3263	3936	4289	4062	2844	2964	
72 20	\$3313	4092	4399	4171	2888	3007	
		4ADP04L	4ADP06L	4ADP07L	4ADLNTL	4ADL03L	4ADL04L
FM73A.60 20	\$3169	2706	2940	3011	3128	3362	
66 20	\$3198	2737	2971	3031	3147	3383	
72 20	\$3242	2778	3015	3078	3195	3429	
		4ADL06L	4ADL07L	4ADWNTL	4ADW04L	4ADW07L	4AFPNTL
FM73A.60 20	\$2901	3136	3696	4051	3823	—	
66 20	\$2921	3155	3851	4202	3976	2945	
72 20	\$2968	3202	3922	4276	4049	2992	
		4AFP03L	4AFP04L	4AFP06L	4AFP07L	4AFLN1L	4AFL03L
FM73A.66 20	\$3066	3299	2836	3072	3138	3254	
72 20	\$3111	3346	2882	3119	3187	3305	
		4AFL04L	4AFL06L	4AFL07L	4AFWNTL	4AFW04L	4AFW07L
FM73A.66 20	\$3490	3028	3263	3936	4289	4062	
72 20	\$3541	3078	3313	4092	4399	4171	
		5AAPNTL	5AAP03L	5AAP04L	5AAP06L	5AAP07L	5AALN1L
FM73A.48 20	\$2472	2589	2824	2361	2597	2637	
60 20	\$2689	2806	3040	2580	2813	2866	

Metal Low Credenza, Open with Drawers *continued*

Canvas Office Landscape® Metal Case Credenzas

	5AAL03L	5AAL04L	5AAL06L	5AAL07L	5AAWNTL	5AAW04L
FM73A.48 20	\$2754	2989	2527	2762	3224	3578
60 20	\$2983	3220	2757	2992	3546	3899
	5AAW07L	5ABPNTL	5ABP03L	5ABP04L	5ABP06L	5ABP07L
FM73A.48 20	\$3350	2472	2589	2824	2361	2597
60 20	\$3671	2689	2806	3040	2580	2813
	5ABLNTL	5ABL03L	5ABL04L	5ABL06L	5ABL07L	5ABWNTL
FM73A.48 20	\$2637	2754	2989	2527	2762	3224
60 20	\$2866	2983	3220	2757	2992	3546
	5ABW04L	5ABW07L	5ACPNTL	5ACP03L	5ACP04L	5ACP06L
FM73A.48 20	\$3578	3350	—	—	—	—
60 20	\$3899	3671	2758	2876	3112	2650
66 20	—	—	\$2787	2907	3141	2677
72 20	—	—	\$2831	2950	3185	2722
	5ACP07L	5ACLNTL	5ACL03L	5ACL04L	5ACL06L	5ACL07L
FM73A.60 20	\$2883	2954	3071	3306	2843	3079
66 20	\$2914	2974	3090	3326	2864	3098
72 20	\$2959	3021	3138	3373	2911	3145
	5ACWNTL	5ACW04L	5ACW07L	5AEPNTL	5AEP03L	5AEP04L
FM73A.60 20	\$3639	3995	3766	—	—	—
66 20	\$3794	4146	3920	2888	3008	3242
72 20	\$3865	4219	3991	2935	3053	3289
	5AEP06L	5AEP07L	5AELNTL	5AEL03L	5AEL04L	5AEL06L
FM73A.66 20	\$2779	3015	3081	3198	3433	2971
72 20	\$2826	3062	3131	3248	3483	3021
	5AEL07L	5AEWNTL	5AEW04L	5AEW07L	5ADPNTL	5ADP03L
FM73A.60 20	—	—	—	—	\$2758	2876
66 20	\$3205	3879	4232	4005	2787	2907
72 20	\$3255	4035	4341	4114	2831	2950
	5ADP04L	5ADP06L	5ADP07L	5ADLNTL	5ADL03L	5ADL04L
FM73A.60 20	\$3112	2650	2883	2954	3071	3306
66 20	\$3141	2677	2914	2974	3090	3326
72 20	\$3185	2722	2959	3021	3138	3373
	5ADL06L	5ADL07L	5ADWNTL	5ADW04L	5ADW07L	5AFPNTL
FM73A.60 20	\$2843	3079	3639	3995	3766	—
66 20	\$2864	3098	3794	4146	3920	2888
72 20	\$2911	3145	3865	4219	3991	2935

	5AFP03L	5AFP04L	5AFP06L	5AFP07L	5AFLNTL	5AFL03L
FM73A.66 20	\$3008	3242	2779	3015	3081	3198
72 20	\$3053	3289	2826	3062	3131	3248
	5AFL04L	5AFL06L	5AFL07L	5AFWNTL	5AFW04L	5AFW07L
FM73A.66 20	\$3433	2971	3205	3879	4232	4005
72 20	\$3483	3021	3255	4035	4341	4114
	2AAPNTL	2AAP03L	2AAP04L	2AAP06L	2AAP07L	2AALNTL
FM73K.48 20	\$2381	2498	2734	2272	2506	2546
60 20	\$2598	2715	2947	2488	2720	2775
	2AAL03L	2AAL04L	2AAL06L	2AAL07L	2AAWNTL	2AAW04L
FM73K.48 20	\$2663	2899	2436	2670	3135	3487
60 20	\$2893	3071	2665	2843	3455	3808
	2AAW07L	2ABPNTL	2ABP03L	2ABP04L	2ABP06L	2ABP07L
FM73K.48 20	\$3259	2381	2498	2734	2272	2506
60 20	\$3581	2598	2715	2950	2488	2720
	2ABLNTL	2ABL03L	2ABL04L	2ABL06L	2ABL07L	2ABWNTL
FM73K.48 20	\$2546	2663	2899	2436	2670	3135
60 20	\$2775	2893	3071	2665	2843	3455
	2ABW04L	2ABW07L	2ACPNTL	2ACP03L	2ACP04L	2ACP06L
FM73K.48 20	\$3487	3259	—	—	—	—
60 20	\$3808	3581	2667	2784	3021	2557
66 20	—	—	\$2700	2818	3052	2591
72 20	—	—	\$2743	2860	3094	2633
	2ACP07L	2ACLNTL	2ACL03L	2ACL04L	2ACL06L	2ACL07L
FM73K.60 20	\$2795	2864	2980	3216	2754	2989
66 20	\$2825	2884	3004	3239	2775	3012
72 20	\$2867	2931	3047	3284	2821	3055
	2ACWNTL	2ACW04L	2ACW07L	2AEPNTL	2AEP03L	2AEP04L
FM73K.60 20	\$3550	3904	3677	—	—	—
66 20	\$3672	4025	3797	2803	2920	3154
72 20	\$3775	4129	3901	2847	2965	3199
	2AEP06L	2AEP07L	2AELNTL	2AEL03L	2AEL04L	2AEL06L
FM73K.66 20	\$2693	2927	2992	3111	3346	2882
72 20	\$2738	2972	3039	3156	3511	2929
	2AEL07L	2AEWNTL	2AEW04L	2AEW07L	2ADPNTL	2ADP03L
FM73K.60 20	—	—	—	—	\$2667	2784
66 20	\$3119	3793	4145	3919	2700	2818

Metal Low Credenza, Open with Drawers *continued*

72 20	\$3284	3899	4251	4025	2743	2860
	2ADP04L	2ADP06L	2ADP07L	2ADLNTL	2ADL03L	2ADL04L
FM73K.60 20	\$3021	2557	2795	2864	2980	3216
66 20	\$3052	2591	2825	2884	3004	3239
72 20	\$3094	2633	2867	2931	3047	3284
	2ADL06L	2ADL07L	2ADWNTL	2ADW04L	2ADW07L	2AFPNTL
FM73K.60 20	\$2754	2989	3550	3904	3677	—
66 20	\$2775	3012	3672	4025	3797	2803
72 20	\$2821	3055	3775	4129	3901	2847
	2AFP03L	2AFP04L	2AFP06L	2AFP07L	2AFLNTL	2AFL03L
FM73K.66 20	\$2920	3154	2693	2927	2992	3111
72 20	\$2965	3199	2738	2972	3039	3156
	2AFL04L	2AFL06L	2AFL07L	2AFWNTL	2AFW04L	2AFW07L
FM73K.66 20	\$3346	2882	3119	3793	4145	3919
72 20	\$3393	2929	3284	3899	4251	4025
	4AAPNTL	4AAP03L	4AAP04L	4AAP06L	4AAP07L	4AALNTL
FM73K.48 20	\$2529	2646	2880	2419	2654	2694
60 20	\$2745	2863	3097	2636	2870	2923
	4AAL03L	4AAL04L	4AAL06L	4AAL07L	4AAWNTL	4AAW04L
FM73K.48 20	\$2810	3045	2584	2819	3281	3634
60 20	\$3040	3277	2813	3049	3602	3956
	4AAW07L	4ABPNTL	4ABP03L	4ABP04L	4ABP06L	4ABP07L
FM73K.48 20	\$3407	2529	2646	2880	2419	2654
60 20	\$3728	2745	2863	3097	2636	2870
	4ABLNTL	4ABL03L	4ABL04L	4ABL06L	4ABL07L	4ABWNTL
FM73K.48 20	\$2694	2810	3045	2584	2819	3281
60 20	\$2923	3040	3277	2813	3049	3602
	4ABW04L	4ABW07L	4ACPNTL	4ACP03L	4ACP04L	4ACP06L
FM73K.48 20	\$3634	3407	—	—	—	—
60 20	\$3956	3728	2814	2933	3169	2706
66 20	—	—	\$2844	2964	3198	2737
72 20	—	—	\$2888	3007	3242	2778
	4ACP07L	4ACLNTL	4ACL03L	4ACL04L	4ACL06L	4ACL07L
FM73K.60 20	\$2940	3011	3128	3362	2901	3136
66 20	\$2971	3031	3147	3383	2921	3155
72 20	\$3015	3078	3195	3429	2968	3202

	4ACWNTL	4ACW04L	4ACW07L	4AEPNTL	4AEP03L	4AEP04L
FM73K.60 20	\$3696	4051	3823	—	—	—
66 20	\$3851	4202	3976	2945	3066	3299
72 20	\$3922	4276	4049	2992	3111	3346
	4AEP06L	4AEP07L	4AELNTL	4AEL03L	4AEL04L	4AEL06L
FM73K.66 20	\$2836	3072	3138	3254	3490	3028
72 20	\$2882	3119	3187	3305	3541	3078
	4AEL07L	4AEWNTL	4AEW04L	4AEW07L	4ADPNTL	4ADP03L
FM73K.60 20	—	—	—	—	\$2814	2933
66 20	\$3263	3936	4289	4062	2844	2964
72 20	\$3313	4092	4399	4171	2888	3007
	4ADP04L	4ADP06L	4ADP07L	4ADLNTL	4ADL03L	4ADL04L
FM73K.60 20	\$3169	2706	2940	3011	3128	3362
66 20	\$3198	2737	2971	3031	3147	3383
72 20	\$3242	2778	3015	3078	3195	3429
	4ADL06L	4ADL07L	4ADWNTL	4ADW04L	4ADW07L	4AFPNTL
FM73K.60 20	\$2901	3136	3696	4051	3823	—
66 20	\$2921	3155	3851	4202	3976	2945
72 20	\$2968	3202	3922	4276	4049	2992
	4AFP03L	4AFP04L	4AFP06L	4AFP07L	4AFLNTL	4AFL03L
FM73K.66 20	\$3066	3299	2836	3072	3138	3254
72 20	\$3111	3346	2882	3119	3187	3305
	4AFL04L	4AFL06L	4AFL07L	4AFWNTL	4AFW04L	4AFW07L
FM73K.66 20	\$3490	3028	3263	3936	4289	4062
72 20	\$3541	3078	3313	4092	4399	4171
	5AAPNTL	5AAP03L	5AAP04L	5AAP06L	5AAP07L	5AALNTL
FM73K.48 20	\$2472	2589	2824	2361	2597	2637
60 20	\$2689	2806	3040	2580	2813	2866
	5AAL03L	5AAL04L	5AAL06L	5AAL07L	5AAWNTL	5AAW04L
FM73K.48 20	\$2754	2989	2527	2762	3224	3578
60 20	\$2983	3220	2757	2992	3546	3899
	5AAW07L	5ABPNTL	5ABP03L	5ABP04L	5ABP06L	5ABP07L
FM73K.48 20	\$3350	2472	2589	2824	2361	2597
60 20	\$3671	2689	2806	3040	2580	2813
	5ABLNTL	5ABL03L	5ABL04L	5ABL06L	5ABL07L	5ABWNTL
FM73K.48 20	\$2637	2754	2989	2527	2762	3224
60 20	\$2866	2983	3220	2757	2992	3546

Canvas Office Landscape® Metal Case Credenzas

Metal Low Credenza, Open with Drawers *continued*

Canvas Office Landscape® Metal Case Credenzas

	5ABW04L	5ABW07L	5ACPNTL	5ACP03L	5ACP04L	5ACP06L
FM73K.48 20	\$3578	3350	—	—	—	—
60 20	\$3899	3671	2758	2876	3112	2650
66 20	—	—	\$2787	2907	3141	2677
72 20	—	—	\$2831	2950	3185	2722

	5ACP07L	5ACLNTL	5ACL03L	5ACL04L	5ACL06L	5ACL07L
FM73K.60 20	\$2883	2954	3071	3306	2843	3079
66 20	\$2914	2974	3090	3326	2864	3098
72 20	\$2959	3021	3138	3373	2911	3145

	5ACWNTL	5ACW04L	5ACW07L	5AEPNTL	5AEP03L	5AEP04L
FM73K.60 20	\$3639	3995	3766	—	—	—
66 20	\$3794	4146	3920	2888	3008	3242
72 20	\$3865	4219	3991	2935	3053	3289

	5AEP06L	5AEP07L	5AELNTL	5AEL03L	5AEL04L	5AEL06L
FM73K.66 20	\$2779	3015	3081	3198	3433	2971
72 20	\$2826	3062	3131	3248	3483	3021

	5AEL07L	5AEWNTL	5AEW04L	5AEW07L	5ADPNTL	5ADP03L
FM73K.60 20	—	—	—	—	\$2758	2876
66 20	\$3205	3879	4232	4005	2787	2907
72 20	\$3255	4035	4341	4114	2831	2950

	5ADP04L	5ADP06L	5ADP07L	5ADLNTL	5ADL03L	5ADL04L
FM73K.60 20	\$3112	2650	2883	2954	3071	3306
66 20	\$3141	2677	2914	2974	3090	3326
72 20	\$3185	2722	2959	3021	3138	3373

	5ADL06L	5ADL07L	5ADWNTL	5ADW04L	5ADW07L	5AFPNTL
FM73K.60 20	\$2843	3079	3639	3995	3766	—
66 20	\$2864	3098	3794	4146	3920	2888
72 20	\$2911	3145	3865	4219	3991	2935

	5AFP03L	5AFP04L	5AFP06L	5AFP07L	5AFLNTL	5AFL03L
FM73K.66 20	\$3008	3242	2779	3015	3081	3198
72 20	\$3053	3289	2826	3062	3131	3248

	5AFL04L	5AFL06L	5AFL07L	5AFWNTL	5AFW04L	5AFW07L
FM73K.66 20	\$3433	2971	3205	3879	4232	4005
72 20	\$3483	3021	3255	4035	4341	4114

Step 10. Paint/Steel Type	
SS	smooth paint on smooth steel +\$0
XS	textured paint on smooth steel +\$0

Step 11. Surface Finish

Metallic Paint	
<i>For smooth paint on smooth steel (SS)</i>	
CN	metallic champagne +\$0
EH	metallic bronze +\$0
MS	metallic silver +\$0

Sand Texture Paint	
<i>For textured paint on smooth steel (XS)</i>	
98	studio white <input type="checkbox"/> +\$0
8Q	folkstone grey <input type="checkbox"/> +\$0
WL	sandstone <input type="checkbox"/> +\$0

Bright Sand Texture Paint	
<i>For textured paint on smooth steel (XS)</i>	
91	white +\$0
CL	cool grey neutral <input type="checkbox"/> +\$0
G1	graphite <input type="checkbox"/> +\$0
WN	warm grey neutral +\$0

Step 12. Front Finish

Solid-Color Laminate	
<i>For laminate front (L)</i>	
8Q	folkstone grey <input type="checkbox"/> +\$0
91	white +\$0
98	studio white +\$0
CL	cool grey neutral <input type="checkbox"/> +\$0
LU	soft white <input type="checkbox"/> +\$0
WL	sandstone <input type="checkbox"/> +\$0
WN	warm grey neutral +\$0

Linen Laminate	
<i>For laminate front (L)</i>	
LBM	crisp linen +\$0
LBN	classic linen +\$0
LBP	casual linen +\$0

Mesh Laminate	
<i>For laminate front (L)</i>	
LBK	pewter mesh +\$0
LBL	steel mesh +\$0

Metal Low Credenza, Open with Drawers *continued*

Twill Laminate

For laminate front (L)

LBF	neutral twill	+\$0
LBG	sarum twill	+\$0
LBH	earthen twill	+\$0
LBJ	graphite twill	+\$0
LBQ	white twill	+\$0

Wood-Grain Laminate

For laminate front (L)

HM	natural maple	+\$0
HP	light anigre A	+\$0
LBA	clear on ash	+\$0
LBR	phantom ecru	+\$0
LBS	phantom cocoa	+\$0
LBU	medium matte walnut	+\$0
LBV	warm grey teak	+\$0
LBB	oak on ash	+\$0
LBC	walnut on ash	+\$0
LBD	dark brown walnut	+\$0
LBE	medium red walnut	+\$0
76	light brown walnut A	+\$0
HX	aged cherry	+\$0
HY	walnut on cherry A	+\$0

Wood Veneer

For veneer front (W)

2U	light brown walnut A	+\$0
40	dark brown walnut A	+\$0
ED	aged cherry A	+\$0
EK	medium red walnut A	+\$0
EW	medium matte walnut A	+\$0
ET	clear on ash A	+\$0
EU	oak on ash A	+\$0
EV	walnut on ash A	+\$0
UL	natural maple A	+\$0
UX	walnut on cherry A	+\$0

Step 13. Top Finish

Solid-Color Laminate

For 3/8" laminate top (o3) or 1 1/4" laminate top (o6)

8Q	folkstone grey A	+\$0
91	white	+\$0
98	studio white	+\$0
CL	cool grey neutral A	+\$0
LU	soft white A	+\$0
WL	sandstone A	+\$0
WN	warm grey neutral	+\$0

Linen Laminate

For 3/8" laminate top (o3) or 1 1/4" laminate top (o6)

LBM	crisp linen	+\$0
LBN	classic linen	+\$0
LBP	casual linen	+\$0

Mesh Laminate

For 3/8" laminate top (o3) or 1 1/4" laminate top (o6)

LBK	pewter mesh	+\$0
LBL	steel mesh	+\$0

Twill Laminate

For 3/8" laminate top (o3) or 1 1/4" laminate top (o6)

LBF	neutral twill	+\$0
LBG	sarum twill	+\$0
LBH	earthen twill	+\$0
LBJ	graphite twill	+\$0
LBQ	white twill	+\$0

Wood-Grain Laminate

For 3/8" laminate top (o3) or 1 1/4" laminate top (o6)

HM	natural maple	+\$0
HP	light anigre A	+\$0
LBA	clear on ash	+\$0
LBR	phantom ecru	+\$0
LBS	phantom cocoa	+\$0
LBU	medium matte walnut	+\$0
LBV	warm grey teak	+\$0
LBB	oak on ash	+\$0
LBC	walnut on ash	+\$0
LBD	dark brown walnut	+\$0
LBE	medium red walnut	+\$0
76	light brown walnut A	+\$0
HX	aged cherry	+\$0
HY	walnut on cherry A	+\$0

Metal Low Credenza, Open with Drawers *continued*

Wood Veneer		
<i>For 3/8" veneer top (04) or 1/4" veneer top (07)</i>		
2U	light brown walnut <input type="checkbox"/> A	+\$0
40	dark brown walnut <input type="checkbox"/> A	+\$0
ED	aged cherry <input type="checkbox"/> A	+\$0
EK	medium red walnut <input type="checkbox"/> A	+\$0
EW	medium matte walnut <input type="checkbox"/> A	+\$0
ET	clear on ash <input type="checkbox"/> A	+\$0
EU	oak on ash <input type="checkbox"/> A	+\$0
EV	walnut on ash <input type="checkbox"/> A	+\$0
UL	natural maple <input type="checkbox"/> A	+\$0
UX	walnut on cherry <input type="checkbox"/> A	+\$0

Step 14. Base Finish		
<i>For 4"-high foot (4) or 4" -high foot sleeveless (5)</i>		
8Q	folkstone grey <input type="checkbox"/> A	+\$0
98	studio white <input type="checkbox"/> A	+\$0
WL	sandstone <input type="checkbox"/> A	+\$0
91	white	+\$0
CL	cool grey neutral <input type="checkbox"/> A	+\$0
G1	graphite <input type="checkbox"/> A	+\$0
WN	warm grey neutral	+\$0

Metallic Paint		
CN	metallic champagne	+\$0
EH	metallic bronze	+\$0
MS	metallic silver	+\$0

Step 15. Pull Finish		
<i>For arc pull (A.)</i>		
NH	brushed nickel	+\$0
NK	black nickel <input type="checkbox"/> A	+\$0

<i>For bar pull (K.)</i>		
8Q	folkstone grey	+\$0
91	white	+\$0
98	studio white	+\$0
G1	graphite <input type="checkbox"/> A	+\$0
WL	sandstone <input type="checkbox"/> A	+\$0
CN	metallic champagne <input type="checkbox"/> A	+\$0
MS	metallic silver	+\$0
79	green apple <input type="checkbox"/> A	+\$15
MY3	yellow oxide <input type="checkbox"/> A	+\$15
RO	red <input type="checkbox"/> A	+\$15
TRQ	turquoise <input type="checkbox"/> A	+\$15

Step 16. Counterweight		
NO	no counterweight	+\$0
CB	counterweight	+\$115

Step 17. Lock Option		
KA	keyed alike	-\$10
KC	keyed differently, chrome	+\$0
KD	keyed differently, black	+\$0

Metal Low Credenza, Doors with Drawers

FM74A.
FM74K.

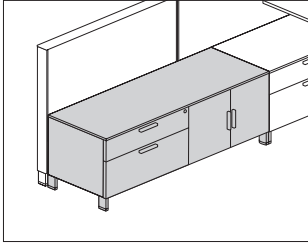

Product Information

Description

This credenza provides enclosed filing and storage and can be used freestanding or attached to a Canvas wall-based frame to support a frame run. It has a $\frac{3}{8}$ "-high or $1\frac{1}{4}$ "-high laminate or veneer top and a painted steel case. It is available with 4"-high architectural feet, 4"-high sleeveless architectural feet or a $2\frac{1}{4}$ "-high base with 1" leveling glides. The credenza has a positive interlock system that permits only 1 drawer to open at a time. Drawers have full-extension ball-bearing slides. The file drawer accommodates front-to-back of letter-, legal, and A4-size hanging files.

Actual credenza widths are $47\frac{7}{8}$ ", $59\frac{7}{8}$ " or $71\frac{7}{8}$ "; actual depth is $19\frac{7}{8}$ ".

Notes

For additional product options, see Vary Easy Program in Appendices. Arc pull option (A.) conforms to guidelines of Americans with Disabilities Act (ADA).

File drawers are standard with side-to-side hardware. Order front-to-back rail (FM920.) separately.

Counterweight option (CB) must be specified when a file is not ganged or anchored.

Grain direction is vertical on veneer and wood-grain laminate fronts. Storage compartment with door(s) includes 1 adjustable shelf that adjusts in $1\frac{1}{4}$ " increments.

Order optional metal credenza shelf (FM892.) separately.

Credenza with 4"-high foot option (4) and $\frac{3}{8}$ " thin top can be used to support a Canvas wall-based frame. Order support bracket, low credenza-to-frame (FT292.) separately.

When using credenza to support 1 end of a surface, order 1 of the following products separately:

- Surface support, low credenza, adjustable height (FT299.)
- Surface support, low credenza, fixed height (FT298.)

To cover adjacent credenzas with a single top, specify credenzas with no top option (NT) and order credenza top (FM890.) separately.

$1\frac{1}{4}$ " top (o6 and o7) is not removable and cannot be used to support a Canvas wall-based frame. The $1\frac{1}{4}$ " top will add $\frac{5}{8}$ " to overall height of unit.

Please note that on the 4" sleeveless architectural foot (5) glides will be more visible.

To provide temporary guest seating on a credenza, order cushion top (FF891.) separately.

For keyed-alike locks, see Keyed-Alike Information in Appendices.

Dimensions

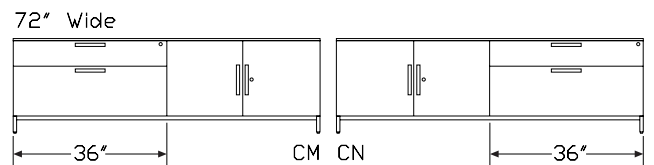
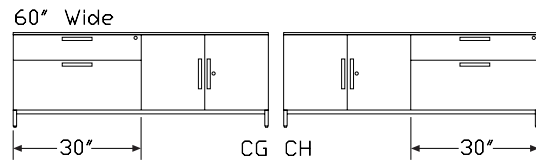
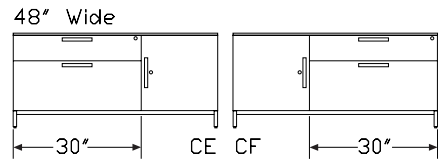
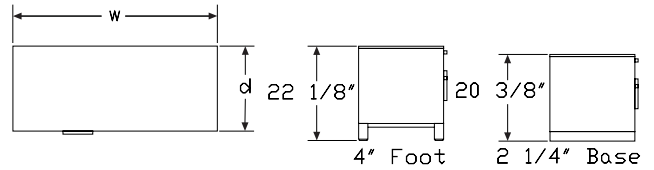

Metal Low Credenza, Doors with Drawers *continued*

Specification Information	
Step 1.	
FM74	<input type="checkbox"/> A
Step 2. Pull Type	
A.	arc pull <input type="checkbox"/> A
K.	bar pull <input type="checkbox"/> A
Step 3. Width	
48	48" wide <input type="checkbox"/> A
60	60" wide <input type="checkbox"/> A
72	72" wide <input type="checkbox"/> A
Step 4. Depth	
20	20" deep <input type="checkbox"/> A
Step 5. Base/Foot Height	
2	2 1/4"-high base <input type="checkbox"/> A
4	4"-high foot <input type="checkbox"/> A
5	4" -high foot sleeveless <input type="checkbox"/> A
Step 6. Configuration	
<i>For 48" wide (48)</i>	
CE	30" box/file left, single door right <input type="checkbox"/> A
CF	single door left, 30" box/file right <input type="checkbox"/> A
<i>For 60" wide (60)</i>	
CG	30" box/file left, double doors right <input type="checkbox"/> A
CH	double doors left, 30" box/file right <input type="checkbox"/> A
CM	36" box/file left, double doors right <input type="checkbox"/> A
CN	double doors left, 36" box/file right <input type="checkbox"/> A
<i>For 72" wide (72)</i>	
CM	36" box/file left, double doors right <input type="checkbox"/> A
CN	double doors left, 36" box/file right <input type="checkbox"/> A
CS	42" box/file left, double doors right <input type="checkbox"/> A
CT	double doors left, 42" box/file right <input type="checkbox"/> A
Step 7. Front Material	
P	painted metal front <input type="checkbox"/> A
L	laminate front <input type="checkbox"/> A
W	veneer front <input type="checkbox"/> A

Step 8. Top	
<i>For painted metal front (P) or laminate front (L)</i>	
NT	no top <input type="checkbox"/> A
03	3/8" laminate top <input type="checkbox"/> A
04	3/8" veneer top <input type="checkbox"/> A
06	1 1/4" laminate top <input type="checkbox"/> A
07	1 1/4" veneer top <input type="checkbox"/> A
<i>For veneer front (W)</i>	
NT	no top <input type="checkbox"/> A
04	3/8" veneer top <input type="checkbox"/> A
07	1 1/4" veneer top <input type="checkbox"/> A
Step 9. Lock	
L	lock <input type="checkbox"/> A
Prices for Steps 1-9.	
	2CEPNTL 2CEP03L 2CEP04L 2CEP06L 2CEP07L 2CELNTL
FM74A. 48 20	\$2417 2536 2770 2309 2544 2586
	2CELO3L 2CELO4L 2CELO6L 2CELO7L 2CEWNTL 2CEW04L
FM74A. 48 20	\$2704 2938 2478 2711 3335 3687
	2CEW07L 2CGPNTL 2CGP03L 2CGP04L 2CGP06L 2CGP07L
FM74A. 48 20	\$3459 — — — — —
60 20	— \$2887 3006 3241 2777 3014
	2CGLNTL 2CGL03L 2CGL04L 2CGL06L 2CGL07L 2CGWNTL
FM74A. 60 20	\$3084 3202 3438 2975 3210 4107
	2CGW04L 2CGW07L 2CFPNTL 2CFP03L 2CFP04L 2CFP06L
FM74A. 48 20	— — \$2417 2536 2770 2309
60 20	\$4458 4231 — — — —
	2CFP07L 2CFLNTL 2CFL03L 2CFL04L 2CFL06L 2CFL07L
FM74A. 48 20	\$2544 2586 2704 2938 2478 2711
	2CFWNTL 2CFW04L 2CFW07L 2CHPNTL 2CHP03L 2CHP04L
FM74A. 48 20	\$3335 3687 3459 — — —
60 20	— — — \$2887 3006 3241
	2CHP06L 2CHP07L 2CHLNTL 2CHL03L 2CHL04L 2CHL06L
FM74A. 60 20	\$2777 3014 3084 3202 3438 2975
	2CHL07L 2CHWNTL 2CHW04L 2CHW07L 2CMPNTL 2CMP03L
FM74A. 60 20	\$3210 4107 4458 4231 3139 3255

Metal Low Credenza, Doors with Drawers *continued*

72 20	—	—	—	—	\$3139	3255
	2CMP04L	2CMP06L	2CMP07L	2CMLN1L	2CML03L	2CML04L
FM74A. 60 20	\$3491	3029	3264	3181	3299	3534
72 20	\$3491	3029	3255	3351	3470	3705
	2CML06L	2CML07L	2CMWNTL	2CMW04L	2CMW07L	2CSPNTL
FM74A. 60 20	\$3072	3307	4241	4592	4366	—
72 20	\$3242	3478	4461	4816	4588	3269
	2CSP03L	2CSP04L	2CSP06L	2CSP07L	2CSLNTL	2CSL03L
FM74A. 72 20	\$3387	3622	3160	3395	3491	3609
	2CSL04L	2CSL06L	2CSL07L	2CSWNTL	2CSW04L	2CSW07L
FM74A. 72 20	\$3845	3325	3618	4654	5007	4780
	2CNPNTL	2CNP03L	2CNP04L	2CNP06L	2CNP07L	2CNLNTL
FM74A. 60 20	\$3139	3255	3491	3029	3264	3181
72 20	\$3139	3255	3491	3029	3255	3351
	2CNL03L	2CNL04L	2CNL06L	2CNL07L	2CNWNTL	2CNW04L
FM74A. 60 20	\$3299	3534	3072	3307	4241	4592
72 20	\$3470	3705	3242	3478	4461	4816
	2CNW07L	2CTPNTL	2CTP03L	2CTP04L	2CTP06L	2CTP07L
FM74A. 60 20	\$4366	—	—	—	—	—
72 20	\$4588	3269	3387	3622	3160	3395
	2CTLNTL	2CTL03L	2CTL04L	2CTL06L	2CTL07L	2CTWNTL
FM74A. 72 20	\$3491	3609	3845	3325	3618	4654
	2CTW04L	2CTW07L	4CEPNTL	4CEP03L	4CEP04L	4CEP06L
FM74A. 48 20	—	—	\$2581	2698	2933	2471
72 20	\$5007	4780	—	—	—	—
	4CEP07L	4CELNTL	4CELO3L	4CELO4L	4CELO6L	4CELO7L
FM74A. 48 20	\$2706	2749	2866	3102	2639	2874
	4CEWNTL	4CEW04L	4CEW07L	4CGPNTL	4CGP03L	4CGP04L
FM74A. 48 20	\$3481	3833	3605	—	—	—
60 20	—	—	—	\$3035	3151	3388
	4CGP06L	4CGP07L	4CGLNTL	4CGL03L	4CGL04L	4CGL06L
FM74A. 60 20	\$2925	3161	3233	3349	3585	3122
	4CGL07L	4CGWNTL	4CGW04L	4CGW07L	4CFPNTL	4CFP03L
FM74A. 48 20	—	—	—	—	\$2581	2698

60 20	\$3357	4252	4605	4378	—	—
	4CFP04L	4CFP06L	4CFP07L	4CFLNTL	4CFL03L	4CFL04L
FM74A. 48 20	\$2933	2471	2706	2749	2866	3102
	4CFL06L	4CFL07L	4CFWNTL	4CFW04L	4CFW07L	4CHPNTL
FM74A. 48 20	\$2639	2874	3481	3833	3605	—
60 20	—	—	—	—	—	\$3035
	4CHP03L	4CHP04L	4CHP06L	4CHP07L	4CHLNTL	4CHL03L
FM74A. 60 20	\$3151	3388	2925	3161	3233	3349
	4CHL04L	4CHL06L	4CHL07L	4CHWNTL	4CHW04L	4CHW07L
FM74A. 60 20	\$3585	3122	3357	4252	4605	4378
	4CMPNTL	4CMP03L	4CMP04L	4CMP06L	4CMP07L	4CMLNTL
FM74A. 60 20	\$3132	3248	3367	3021	3139	3334
72 20	\$3286	3404	3638	3177	3411	3497
	4CML03L	4CML04L	4CML06L	4CML07L	4CMWNTL	4CMW04L
FM74A. 60 20	\$3451	3686	3223	3458	4387	4740
72 20	\$3617	3852	3389	3624	4611	4962
	4CMW07L	4CSPNTL	4CSP03L	4CSP04L	4CSP06L	4CSP07L
FM74A. 60 20	\$4512	—	—	—	—	—
72 20	\$4735	3422	3541	3775	3313	3548
	4CSLNTL	4CSL03L	4CSL04L	4CSL06L	4CSL07L	4CSWNTL
FM74A. 72 20	\$3631	3749	3985	3522	3758	4800
	4CSW04L	4CSW07L	4CNPNTL	4CNP03L	4CNP04L	4CNP06L
FM74A. 60 20	—	—	\$3132	3248	3367	3021
72 20	\$5156	4927	3286	3404	3638	3177
	4CNP07L	4CNLNTL	4CNL03L	4CNL04L	4CNL06L	4CNL07L
FM74A. 60 20	\$3139	3334	3451	3686	3223	3458
72 20	\$3411	3497	3617	3852	3389	3624
	4CNWNTL	4CNW04L	4CNW07L	4CTPNTL	4CTP03L	4CTP04L
FM74A. 60 20	\$4387	4740	4512	—	—	—
72 20	\$4611	4962	4735	3422	3541	3775
	4CTP06L	4CTP07L	4CTLNTL	4CTL03L	4CTL04L	4CTL06L
FM74A. 72 20	\$3313	3548	3631	3749	3985	3522
	4CTL07L	4CTWNTL	4CTW04L	4CTW07L	5CEPNTL	5CEP03L
FM74A. 48 20	—	—	—	—	\$2524	2641

Canvas Office Landscape® Metal Case Credenzas

Metal Low Credenza, Doors with Drawers *continued*

Canvas Office Landscape® Metal Case Credenzas

72 20	\$3758	4800	5156	4927	—	—
	5CEP04L	5CEP06L	5CEP07L	5CELNTL	5CELO3L	5CELO4L
FM74A.48 20	\$2876	2414	2650	2692	2809	3044
	5CELO6L	5CELO7L	5CEWNTL	5CEW04L	5CEW07L	5CGPNTL
FM74A.48 20	\$2583	2818	3424	3776	3549	—
60 20	—	—	—	—	—	\$3176
	5CGP03L	5CGP04L	5CGP06L	5CGP07L	5CGLNTL	5CGL03L
FM74A.60 20	\$3292	3528	3066	3301	2978	3095
	5CGL04L	5CGL06L	5CGL07L	5CGWNTL	5CGW04L	5CGW07L
FM74A.60 20	\$3332	2868	3104	4196	4548	4321
	5CFPNTL	5CFP03L	5CFP04L	5CFP06L	5CFP07L	5CFLNTL
FM74A.48 20	\$2524	2641	2876	2414	2650	2692
	5CFL03L	5CFL04L	5CFL06L	5CFL07L	5CFWNTL	5CFW04L
FM74A.48 20	\$2809	3044	2583	2818	3424	3776
	5CFW07L	5CHPNTL	5CHP03L	5CHP04L	5CHP06L	5CHP07L
FM74A.48 20	\$3549	—	—	—	—	—
60 20	—	\$3176	3292	3528	3066	3301
	5CHLNTL	5CHL03L	5CHL04L	5CHL06L	5CHL07L	5CHWNTL
FM74A.60 20	\$2978	3095	3332	2868	3104	4196
	5CHW04L	5CHW07L	5CMPNTL	5CMP03L	5CMP04L	5CMP06L
FM74A.60 20	\$4548	4321	3277	3394	3629	3167
72 20	—	—	\$3441	3560	3795	3333
	5CMP07L	5CMLNTL	5CML03L	5CML04L	5CML06L	5CML07L
FM74A.60 20	\$3402	3075	3191	3309	2965	3082
72 20	\$3567	3230	3347	3582	3120	3354
	5CMWNTL	5CMW04L	5CMW07L	5CSPNTL	5CSP03L	5CSP04L
FM74A.60 20	\$4331	4683	4455	—	—	—
72 20	\$4553	4905	4679	3575	3692	3928
	5CSP06L	5CSP07L	5CSLNTL	5CSL03L	5CSL04L	5CSL06L
FM74A.72 20	\$3464	3701	3366	3483	3718	3255
	5CSL07L	5CSWNTL	5CSW04L	5CSW07L	5CNPNTL	5CNP03L
FM74A.60 20	—	—	—	—	\$3277	3394
72 20	\$3491	4744	5099	4870	3441	3560

	5CNP04L	5CNP06L	5CNP07L	5CNLNTL	5CNL03L	5CNL04L
FM74A.60 20	\$3629	3167	3402	3075	3191	3309
72 20	\$3795	3333	3567	3230	3347	3582
	5CNL06L	5CNL07L	5CNWNTL	5CNW04L	5CNW07L	5CTPNTL
FM74A.60 20	\$2965	3082	4331	4683	4455	—
72 20	\$3120	3354	4553	4905	4679	3575
	5CTP03L	5CTP04L	5CTP06L	5CTP07L	5CTLNTL	5CTL03L
FM74A.72 20	\$3692	3928	3464	3701	3366	3483
	5CTL04L	5CTL06L	5CTL07L	5CTWNTL	5CTW04L	5CTW07L
FM74A.72 20	\$3718	3255	3491	4744	5099	4870
	2CEPNTL	2CEP03L	2CEP04L	2CEP06L	2CEP07L	2CELNTL
FM74K.48 20	\$2417	2536	2770	2309	2544	2586
	2CEL03L	2CEL04L	2CEL06L	2CEL07L	2CEWNTL	2CEW04L
FM74K.48 20	\$2704	2938	2478	2711	3335	3687
	2CEW07L	2CGPNTL	2CGP03L	2CGP04L	2CGP06L	2CGP07L
FM74K.48 20	\$3459	—	—	—	—	—
60 20	—	\$2887	3006	3241	2777	3014
	2CGLNTL	2CGL03L	2CGL04L	2CGL06L	2CGL07L	2CGWNTL
FM74K.60 20	\$3084	3202	3438	2975	3210	4107
	2CGW04L	2CGW07L	2CFPNTL	2CFP03L	2CFP04L	2CFP06L
FM74K.48 20	—	—	\$2417	2536	2770	2309
60 20	\$4458	4231	—	—	—	—
	2CFP07L	2CFLNTL	2CFL03L	2CFL04L	2CFL06L	2CFL07L
FM74K.48 20	\$2544	2586	2704	2938	2478	2711
	2CFWNTL	2CFW04L	2CFW07L	2CHPNTL	2CHP03L	2CHP04L
FM74K.48 20	\$3335	3687	3459	—	—	—
60 20	—	—	—	\$2887	3006	3241
	2CHP06L	2CHP07L	2CHLNTL	2CHL03L	2CHL04L	2CHL06L
FM74K.60 20	\$2777	3014	3084	3202	3438	2975
	2CHL07L	2CHWNTL	2CHW04L	2CHW07L	2CMPNTL	2CMP03L
FM74K.60 20	\$3210	4107	4458	4231	3139	3255
72 20	—	—	—	—	\$3139	3255
	2CMP04L	2CMP06L	2CMP07L	2CMLNTL	2CML03L	2CML04L
FM74K.60 20	\$3491	3029	3264	3181	3299	3534

Metal Low Credenza, Doors with Drawers *continued*

72 20	\$3491	3029	3255	3351	3470	3705
	2CML06L	2CML07L	2CMWNTL	2CMW04L	2CMW07L	2CSPNTL
FM74K.60 20	\$3072	3307	4241	4592	4366	—
72 20	\$3242	3478	4461	4816	4588	3269
	2CSP03L	2CSP04L	2CSP06L	2CSP07L	2CSLNTL	2CSL03L
FM74K.72 20	\$3387	3622	3160	3395	3491	3609
	2CSL04L	2CSL06L	2CSL07L	2CSWNTL	2CSW04L	2CSW07L
FM74K.72 20	\$3845	3325	3618	4654	5007	4780
	2CNPNTL	2CNP03L	2CNP04L	2CNP06L	2CNP07L	2CNLNTL
FM74K.60 20	\$3139	3255	3491	3029	3264	3181
72 20	\$3139	3255	3491	3029	3255	3351
	2CNL03L	2CNL04L	2CNL06L	2CNL07L	2CNWNTL	2CNW04L
FM74K.60 20	\$3299	3534	3072	3307	4241	4592
72 20	\$3470	3705	3242	3478	4461	4816
	2CNW07L	2CTPNTL	2CTP03L	2CTP04L	2CTP06L	2CTP07L
FM74K.60 20	\$4366	—	—	—	—	—
72 20	\$4588	3269	3387	3622	3160	3395
	2CTLNTL	2CTL03L	2CTL04L	2CTL06L	2CTL07L	2CTWNTL
FM74K.72 20	\$3491	3609	3845	3325	3618	4654
	2CTW04L	2CTW07L	4CEPNTL	4CEP03L	4CEP04L	4CEP06L
FM74K.48 20	—	—	\$2581	2698	2933	2471
72 20	\$5007	4780	—	—	—	—
	4CEP07L	4CELNTL	4CELO3L	4CELO4L	4CELO6L	4CELO7L
FM74K.48 20	\$2706	2749	2866	3102	2639	2874
	4CEWNTL	4CEW04L	4CEW07L	4CGPNTL	4CGP03L	4CGP04L
FM74K.48 20	\$3481	3833	3605	—	—	—
60 20	—	—	—	\$3035	3151	3388
	4CGP06L	4CGP07L	4CGLNTL	4CGL03L	4CGL04L	4CGL06L
FM74K.60 20	\$2925	3161	3233	3349	3585	3122
	4CGL07L	4CGWNTL	4CGW04L	4CGW07L	4CFPNTL	4CFP03L
FM74K.48 20	—	—	—	—	\$2581	2698
60 20	\$3357	4252	4605	4378	—	—
	4CFP04L	4CFP06L	4CFP07L	4CFLNTL	4CFL03L	4CFL04L
FM74K.48 20	\$2933	2471	2706	2749	2866	3102

	4CFLO6L	4CFLO7L	4CFWNTL	4CFW04L	4CFW07L	4CHPNTL
FM74K.48 20	\$2639	2874	3481	3833	3605	—
60 20	—	—	—	—	—	\$3035
	4CHP03L	4CHP04L	4CHP06L	4CHP07L	4CHLNTL	4CHL03L
FM74K.60 20	\$3151	3388	2925	3161	3233	3349
	4CHL04L	4CHL06L	4CHL07L	4CHWNTL	4CHW04L	4CHW07L
FM74K.60 20	\$3585	3122	3357	4252	4605	4378
	4CMPNTL	4CMP03L	4CMP04L	4CMP06L	4CMP07L	4CMLNTL
FM74K.60 20	\$3132	3248	3367	3021	3139	3334
72 20	\$3286	3404	3638	3177	3411	3497
	4CML03L	4CML04L	4CML06L	4CML07L	4CMWNTL	4CMW04L
FM74K.60 20	\$3451	3686	3223	3458	4387	4740
72 20	\$3617	3852	3242	3478	4611	4962
	4CMW07L	4CSPNTL	4CSP03L	4CSP04L	4CSP06L	4CSP07L
FM74K.60 20	\$4512	—	—	—	—	—
72 20	\$4735	3422	3541	3775	3313	3548
	4CSLNTL	4CSL03L	4CSL04L	4CSL06L	4CSL07L	4CSWNTL
FM74K.72 20	\$3631	3749	3985	3522	3451	4800
	4CSW04L	4CSW07L	4CNPNTL	4CNP03L	4CNP04L	4CNP06L
FM74K.60 20	—	—	\$3132	3248	3367	3021
72 20	\$5156	4927	3286	3404	3638	3177
	4CNP07L	4CNLNTL	4CNL03L	4CNL04L	4CNL06L	4CNL07L
FM74K.60 20	\$3139	3334	3451	3686	3223	3458
72 20	\$3411	3497	3617	3852	3389	3624
	4CNWNTL	4CNW04L	4CNW07L	4CTPNTL	4CTP03L	4CTP04L
FM74K.60 20	\$4387	4740	4512	—	—	—
72 20	\$4611	4962	4735	3422	3541	3775
	4CTP06L	4CTP07L	4CTLNTL	4CTL03L	4CTL04L	4CTL06L
FM74K.72 20	\$3313	3548	3631	3749	3985	3522
	4CTL07L	4CTWNTL	4CTW04L	4CTW07L	5CEPNTL	5CEP03L
FM74K.48 20	—	—	—	—	\$2524	2641
72 20	\$3758	4800	5156	4927	—	—
	5CEP04L	5CEP06L	5CEP07L	5CELNTL	5CELO3L	5CELO4L
FM74K.48 20	\$2876	2414	2650	2692	2809	3044

Canvas Office Landscape® Metal Case Credenzas

Metal Low Credenza, Doors with Drawers *continued*

Canvas Office Landscape® Metal Case Credenzas

	5CELO6L	5CELO7L	5CEWNTL	5CEW04L	5CEW07L	5CGPNL
FM74K.48 20	\$2583	2818	3424	3776	3549	—
60 20	—	—	—	—	—	\$3176
	5CGP03L	5CGP04L	5CGP06L	5CGP07L	5CGLNLT	5CGL03L
FM74K.60 20	\$3292	3528	3066	3301	2978	3095
	5CGL04L	5CGL06L	5CGL07L	5CGWNTL	5CGW04L	5CGW07L
FM74K.60 20	\$3332	2868	3104	4196	4548	4321
	5CFPNTL	5CFP03L	5CFP04L	5CFP06L	5CFP07L	5CFLNLT
FM74K.48 20	\$2524	2641	2876	2414	2650	2692
	5CFL03L	5CFL04L	5CFL06L	5CFL07L	5CFWNTL	5CFW04L
FM74K.48 20	\$2809	3044	2583	2818	3424	3776
	5CFW07L	5CHPNTL	5CHP03L	5CHP04L	5CHP06L	5CHP07L
FM74K.48 20	\$3549	—	—	—	—	—
60 20	—	\$3176	3292	3528	3066	3301
	5CHLNTL	5CHL03L	5CHL04L	5CHL06L	5CHL07L	5CHWNTL
FM74K.60 20	\$2978	3095	3332	2868	3104	4196
	5CHW04L	5CHW07L	5CMPNTL	5CMP03L	5CMP04L	5CMP06L
FM74K.60 20	\$4548	4321	3277	3394	3629	3167
72 20	—	—	\$3230	3347	3582	3120
	5CMP07L	5CMLNLT	5CML03L	5CML04L	5CML06L	5CML07L
FM74K.60 20	\$3402	3075	3191	3309	2965	3082
72 20	\$3354	3441	3560	3795	3333	3567
	5CMWNTL	5CMW04L	5CMW07L	5CSPNTL	5CSP03L	5CSP04L
FM74K.60 20	\$4331	4683	4455	—	—	—
72 20	\$4553	4905	4679	3366	3483	3718
	5CSP06L	5CSP07L	5CSLNTL	5CSL03L	5CSL04L	5CSL06L
FM74K.72 20	\$3255	3491	3575	3692	3928	3464
	5CSL07L	5CSWNTL	5CSW04L	5CSW07L	5CNPNTL	5CNP03L
FM74K.60 20	—	—	—	—	\$3277	3394
72 20	\$3701	4744	5099	4870	3230	3347
	5CNP04L	5CNP06L	5CNP07L	5CNLNTL	5CNL03L	5CNL04L
FM74K.60 20	\$3629	3167	3402	3075	3191	3309
72 20	\$3582	3120	3354	3441	3560	3795

	5CNL06L	5CNL07L	5CNWNTL	5CNW04L	5CNW07L	5CTPNTL
FM74K.60 20	\$2965	3082	4331	4683	4455	—
72 20	\$3333	3567	4553	4905	4679	3366
	5CTP03L	5CTP04L	5CTP06L	5CTP07L	5CTLNLT	5CTL03L
FM74K.72 20	\$3483	3718	3255	3491	3575	3692
	5CTL04L	5CTL06L	5CTL07L	5CTWNTL	5CTW04L	5CTW07L
FM74K.72 20	\$3928	3464	3701	4744	5099	4870

Step 10. Paint/Steel Type

SS	smooth paint on smooth steel	<input type="checkbox"/> A	+\$0
XS	textured paint on smooth steel	<input type="checkbox"/> A	+\$0

Step 11. Surface Finish

Metallic Paint

For smooth paint on smooth steel (SS)

CN	metallic champagne	<input type="checkbox"/> A	+\$0
EH	metallic bronze	<input type="checkbox"/> A	+\$0
MS	metallic silver	<input type="checkbox"/> A	+\$0

For textured paint on smooth steel (XS)

98	studio white	<input type="checkbox"/> A	+\$0
8Q	folkstone grey	<input type="checkbox"/> A	+\$0
WL	sandstone	<input type="checkbox"/> A	+\$0

For textured paint on smooth steel (XS)

91	white	<input type="checkbox"/> A	+\$0
CL	cool grey neutral	<input type="checkbox"/> A	+\$0
G1	graphite	<input type="checkbox"/> A	+\$0
WN	warm grey neutral	<input type="checkbox"/> A	+\$0

Step 12. Front Finish

Solid-Color Laminate

For laminate front (L)

8Q	folkstone grey	<input type="checkbox"/> A	+\$0
91	white	<input type="checkbox"/> A	+\$0
98	studio white		+\$0
CL	cool grey neutral	<input type="checkbox"/> A	+\$0
LU	soft white	<input type="checkbox"/> A	+\$0
WL	sandstone	<input type="checkbox"/> A	+\$0
WN	warm grey neutral	<input type="checkbox"/> A	+\$0

Metal Low Credenza, Doors with Drawers *continued*

Linen Laminate		
<i>For laminate front (L)</i>		
LBM	crisp linen	+\$0
LBN	classic linen	+\$0
LBP	casual linen	+\$0

Mesh Laminate		
<i>For laminate front (L)</i>		
LBK	pewter mesh	+\$0
LBL	steel mesh	+\$0

Twill Laminate		
<i>For laminate front (L)</i>		
LBF	neutral twill	+\$0
LBG	sarum twill	+\$0
LBH	earthen twill	+\$0
LBJ	graphite twill	+\$0
LBQ	white twill	+\$0

Wood-Grain Laminate		
<i>For laminate front (L)</i>		
HM	natural maple A	+\$0
HP	light anigre A	+\$0
LBA	clear on ash	+\$0
LBR	phantom ecru	+\$0
LBS	phantom cocoa	+\$0
LBU	medium matte walnut	+\$0
LBV	warm grey teak	+\$0
LBB	oak on ash	+\$0
LBC	walnut on ash	+\$0
LBD	dark brown walnut	+\$0
LBE	medium red walnut	+\$0
76	light brown walnut A	+\$0
HX	aged cherry A	+\$0
HY	walnut on cherry A	+\$0

Wood Veneer		
<i>For veneer front (W)</i>		
2U	light brown walnut A	+\$0
40	dark brown walnut A	+\$0
ED	aged cherry A	+\$0
EK	medium red walnut A	+\$0
EW	medium matte walnut A	+\$0
ET	clear on ash A	+\$0
EU	oak on ash A	+\$0
EV	walnut on ash A	+\$0
UL	natural maple A	+\$0
UX	walnut on cherry A	+\$0

Step 13. Top Finish

Solid-Color Laminate		
<i>For 3/8" laminate top (o3) or 1 1/4" laminate top (o6)</i>		
8Q	folkstone grey A	+\$0
91	white A	+\$0
98	studio white	+\$0
CL	cool grey neutral A	+\$0
LU	soft white A	+\$0
WL	sandstone A	+\$0
WN	warm grey neutral A	+\$0

Linen Laminate		
<i>For 3/8" laminate top (o3) or 1 1/4" laminate top (o6)</i>		
LBM	crisp linen	+\$0
LBN	classic linen	+\$0
LBP	casual linen	+\$0

Mesh Laminate		
<i>For 3/8" laminate top (o3) or 1 1/4" laminate top (o6)</i>		
LBK	pewter mesh	+\$0
LBL	steel mesh	+\$0

Twill Laminate		
<i>For 3/8" laminate top (o3) or 1 1/4" laminate top (o6)</i>		
LBF	neutral twill	+\$0
LBG	sarum twill	+\$0
LBH	earthen twill	+\$0
LBJ	graphite twill	+\$0
LBQ	white twill	+\$0

Metal Low Credenza, Doors with Drawers *continued*

Wood-Grain Laminate

For 3/8" laminate top (03) or 1 1/4" laminate top (06)

HM	natural maple <input type="checkbox"/>	+\$0
HP	light anigre <input type="checkbox"/>	+\$0
LBA	clear on ash	+\$0
LBR	phantom ecru	+\$0
LBS	phantom cocoa	+\$0
LBU	medium matte walnut	+\$0
LBV	warm grey teak	+\$0
LBB	oak on ash	+\$0
LBC	walnut on ash	+\$0
LBD	dark brown walnut	+\$0
LBE	medium red walnut	+\$0
76	light brown walnut <input type="checkbox"/>	+\$0
HX	aged cherry <input type="checkbox"/>	+\$0
HY	walnut on cherry <input type="checkbox"/>	+\$0

Wood Veneer

For 3/8" veneer top (04) or 1 1/4" veneer top (07)

2U	light brown walnut <input type="checkbox"/>	+\$0
40	dark brown walnut <input type="checkbox"/>	+\$0
ED	aged cherry <input type="checkbox"/>	+\$0
EK	medium red walnut <input type="checkbox"/>	+\$0
EW	medium matte walnut <input type="checkbox"/>	+\$0
ET	clear on ash <input type="checkbox"/>	+\$0
EU	oak on ash <input type="checkbox"/>	+\$0
EV	walnut on ash <input type="checkbox"/>	+\$0
UL	natural maple <input type="checkbox"/>	+\$0
UX	walnut on cherry <input type="checkbox"/>	+\$0

Step 14. Base Finish

For 4"-high foot (4) or 4"-high foot sleeveless (5)

8Q	folkstone grey <input type="checkbox"/>	+\$0
98	studio white <input type="checkbox"/>	+\$0
WL	sandstone <input type="checkbox"/>	+\$0

Bright Sand Texture Paint

91	white <input type="checkbox"/>	+\$0
CL	cool grey neutral <input type="checkbox"/>	+\$0
G1	graphite <input type="checkbox"/>	+\$0
WN	warm grey neutral <input type="checkbox"/>	+\$0

Metallic Paint

CN	metallic champagne <input type="checkbox"/>	+\$0
EH	metallic bronze <input type="checkbox"/>	+\$0
MS	metallic silver <input type="checkbox"/>	+\$0

Step 15. Pull Finish

For arc pull (A.)

NH	brushed nickel <input type="checkbox"/>	+\$0
NK	black nickel <input type="checkbox"/>	+\$0

For bar pull (K.)

8Q	folkstone grey	+\$0
91	white	+\$0
98	studio white <input type="checkbox"/>	+\$0
G1	graphite <input type="checkbox"/>	+\$0
WL	sandstone <input type="checkbox"/>	+\$0
CN	metallic champagne <input type="checkbox"/>	+\$0
MS	metallic silver <input type="checkbox"/>	+\$0
79	green apple <input type="checkbox"/>	+\$15
MY3	yellow oxide <input type="checkbox"/>	+\$15
RO	red <input type="checkbox"/>	+\$15
TRQ	turquoise <input type="checkbox"/>	+\$15

Step 16. Counterweight

NO	no counterweight <input type="checkbox"/>	+\$0
CB	counterweight <input type="checkbox"/>	+\$115

Step 17. Lock Option

KA	keyed alike <input type="checkbox"/>	-\$10
KC	keyed differently, chrome <input type="checkbox"/>	+\$0
KD	keyed differently, black <input type="checkbox"/>	+\$0

Metal High Credenza, Open

FM800.

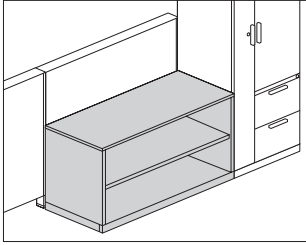

Product Information

Description

This freestanding credenza provides open storage. It has a 3/8"- or 1 1/4"-high laminate or veneer top and a painted steel case. The credenza has a 2 1/4"-high base with 1" leveling glides.

Actual credenza widths are 29 7/8", 35 7/8", or 41 7/8"; actual depth is 19 7/8".

Notes

For additional product options, see Vary Easy Program® in Appendices.

Grain direction is vertical on veneer and wood-grain laminate fronts.

Credenza has no center divider and includes 1 adjustable shelf that adjusts in 1 1/4" increments.

Order optional metal credenza shelf (FM892.) separately.

To cover adjacent credenzas with a single top, specify credenzas with no top option (NT) and order credenza top (FM890.) separately.

Dimensions

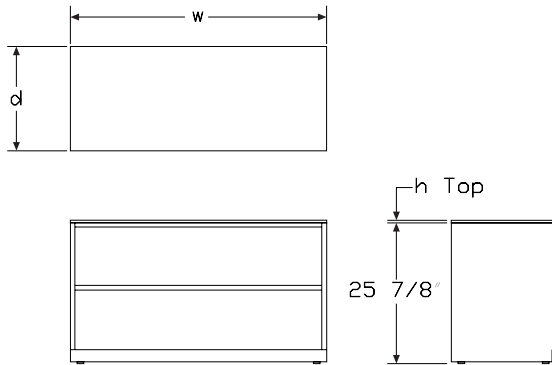

Specification Information

Step 1.

FM800. [A]

Step 2. Width

30 30" wide [A]

36 36" wide [A]

42 42" wide [A]

Step 3. Depth

20 20" deep [A]

Step 4. Base Height

2 2 1/4"-high base [A]

Step 5. Top

NT no top [A]

03 3/8" laminate top [A]

04 3/8" veneer top [A]

06 1 1/4" laminate top [A]

07 1 1/4" veneer top [A]

Prices for Steps 1-5.

	2NT	203	204	206	207
FM800. 30 20	\$1249	1364	1596	1312	1534
36 20	\$1346	1461	1692	1404	1626
42 20	\$1491	1605	1836	1543	1765

Step 6. Paint/Steel Type

SS smooth paint on smooth steel [A] +\$0

XS textured paint on smooth steel [A] +\$0

Step 7. Surface Finish

Metallic Paint

For smooth paint on smooth steel (SS)

CN metallic champagne [A] +\$0

EH metallic bronze [A] +\$0

MS metallic silver [A] +\$0

Sand Texture Paint

For textured paint on smooth steel (XS)

98 studio white [A] +\$0

8Q folkstone grey [A] +\$0

WL sandstone [A] +\$0

Metal High Credenza, Open *continued*

Bright Sand Texture Paint
For textured paint on smooth steel (XS)

91	white A	+\$0
CL	cool grey neutral A	+\$0
G1	graphite A	+\$0
WN	warm grey neutral A	+\$0

Step 8. Top Finish

Solid-Color Laminate
For 3/8" laminate top (03) or 1 1/4" laminate top (06)

8Q	folkstone grey A	+\$0
91	white A	+\$0
98	studio white	+\$0
CL	cool grey neutral A	+\$0
LU	soft white A	+\$0
WL	sandstone A	+\$0
WN	warm grey neutral A	+\$0

Linen Laminate
For 3/8" laminate top (03) or 1 1/4" laminate top (06)

LBM	crisp linen	+\$0
LBN	classic linen	+\$0
LBP	casual linen	+\$0

Mesh Laminate
For 3/8" laminate top (03) or 1 1/4" laminate top (06)

LBK	pewter mesh	+\$0
LBL	steel mesh	+\$0

Twill Laminate
For 3/8" laminate top (03) or 1 1/4" laminate top (06)

LBF	neutral twill	+\$0
LBG	sarum twill	+\$0
LBH	earthen twill	+\$0
LBJ	graphite twill	+\$0
LBQ	white twill	+\$0

Wood-Grain Laminate
For 3/8" laminate top (03) or 1 1/4" laminate top (06)

HM	natural maple A	+\$0
HP	light anigre A	+\$0
LBA	clear on ash	+\$0
LBR	phantom ecru	+\$0
LBS	phantom cocoa	+\$0
LBU	medium matte walnut	+\$0
LBV	warm grey teak	+\$0
LBB	oak on ash	+\$0
LBC	walnut on ash	+\$0
LBD	dark brown walnut	+\$0
LBE	medium red walnut	+\$0
76	light brown walnut A	+\$0
HX	aged cherry A	+\$0
HY	walnut on cherry A	+\$0

Wood Veneer
For 3/8" veneer top (04) or 1 1/4" veneer top (07)

2U	light brown walnut A	+\$0
40	dark brown walnut A	+\$0
ED	aged cherry A	+\$0
EK	medium red walnut A	+\$0
EW	medium matte walnut A	+\$0
ET	clear on ash A	+\$0
EU	oak on ash A	+\$0
EV	walnut on ash A	+\$0
UL	natural maple A	+\$0
UX	walnut on cherry A	+\$0

Metal High Credenza, with Doors

FM80A.
FM80K.

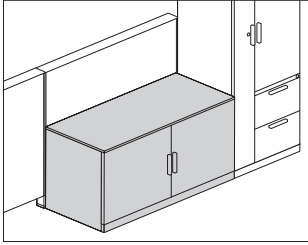

Product Information

Description

This freestanding credenza provides enclosed storage. It has a 3/8"- or 1 1/4"-high laminate or veneer top and a painted steel case with painted, laminate, or veneer front. The credenza has a 2 1/4"-high base with 1" leveling glides.

Notes

For additional product options, see Vary Easy Program in Appendices.

Arc pull option (A.) conforms to guidelines of Americans with Disabilities Act (ADA).

Grain direction is vertical on veneer and wood-grain laminate fronts.

Credenza has no center divider and includes 1 adjustable shelf that adjusts in 1 1/4" increments.

Order optional metal credenza shelf (FM892.) separately.

To cover adjacent credenzas with a single top, specify credenzas with no top option (NT) and order credenza top (FM890.) separately.

For keyed-alike locks, see Keyed-Alike Information in Appendices.

Dimensions

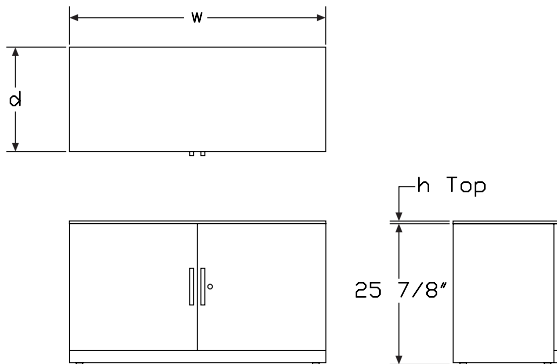

Specification Information

Step 1.

FM80 A

Step 2. Pull Type

A. arc pull A

K. bar pull A

Step 3. Width

30 30" wide A

36 36" wide A

42 42" wide A

Step 4. Depth

20 20" deep A

Step 5. Base Height

2 2 1/4"-high base A

Step 6. Door Material

P painted door A

L laminate doors A

W veneer doors A

Step 7. Top

For painted door (P) or laminate doors (L)

NT no top A

03 3/8" laminate top A

04 3/8" veneer top A

06 1 1/4" laminate top A

For veneer doors (W)

NT no top A

04 3/8" veneer top A

07 1 1/4" veneer top A

Step 8. Lock

L lock A

Prices for Steps 1-8.

	2PNTL	2P03L	2P04L	2P06L	2LNTL	2L03L
FM80A.30 20	\$1382	1497	1728	1439	1532	1647
36 20	\$1478	1594	1825	1532	1637	1753
42 20	\$1624	1739	1969	1671	1798	1912

Metal High Credenza, with Doors

continued

	2L04L	2L06L	2WN7L	2W04L	2W07L
FM80A.30 20	\$1878	1584	2255	2601	2500
36 20	\$1983	1686	2422	2767	2767
42 20	\$2142	1838	2674	3021	2905

	2PN7L	2P03L	2P04L	2P06L	2LN7L	2L03L
FM80K.30 20	\$1382	1497	1728	1439	1532	1647
36 20	\$1478	1594	1825	1532	1637	1753
42 20	\$1624	1739	1969	1671	1798	1912

	2L04L	2L06L	2WN7L	2W04L	2W07L
FM80K.30 20	\$1878	1584	2255	2601	2500
36 20	\$1983	1686	2422	2767	2660
42 20	\$2142	1838	2674	3021	2905

Step 9. Paint/Steel Type

SS	smooth paint on smooth steel A	+\$0
XS	textured paint on smooth steel A	+\$0

Step 10. Surface Finish

Metallic Paint

For smooth paint on smooth steel (SS)

CN	metallic champagne A	+\$0
EH	metallic bronze A	+\$0
MS	metallic silver A	+\$0

Sand Texture Paint

For textured paint on smooth steel (XS)

98	studio white A	+\$0
8Q	folkstone grey A	+\$0
WL	sandstone A	+\$0

Bright Sand Texture Paint

For textured paint on smooth steel (XS)

91	white A	+\$0
CL	cool grey neutral A	+\$0
G1	graphite A	+\$0
WN	warm grey neutral A	+\$0

Step 11. Front Finish

Solid-Color Laminate

For laminate doors (L)

8Q	folkstone grey A	+\$0
91	white A	+\$0
98	studio white	+\$0
CL	cool grey neutral A	+\$0
LU	soft white A	+\$0
WL	sandstone A	+\$0
WN	warm grey neutral A	+\$0

Linon Laminate

For laminate doors (L)

LBM	crisp linon	+\$0
LBN	classic linon	+\$0
LBP	casual linon	+\$0

Mesh Laminate

For laminate doors (L)

LBK	pewter mesh	+\$0
LBL	steel mesh	+\$0

For laminate doors (L)

LBF	neutral twill	+\$0
LBG	sarum twill	+\$0
LBH	earthen twill	+\$0
LBJ	graphite twill	+\$0
LBQ	white twill	+\$0

Wood-Grain Laminate

For laminate doors (L)

HM	natural maple A	+\$0
HP	light anigre A	+\$0
LBA	clear on ash	+\$0
LBR	phantom ecru	+\$0
LBS	phantom cocoa	+\$0
LBU	medium matte walnut	+\$0
LBV	warm grey teak	+\$0
LBB	oak on ash	+\$0
LBC	walnut on ash	+\$0
LBD	dark brown walnut	+\$0
LBE	medium red walnut	+\$0
76	light brown walnut A	+\$0
HX	aged cherry A	+\$0
HY	walnut on cherry A	+\$0

Metal High Credenza, with Doors

continued

Wood Veneer

For veneer doors (W)

2U	light brown walnut <input type="checkbox"/>	+\$0
40	dark brown walnut <input type="checkbox"/>	+\$0
ED	aged cherry <input type="checkbox"/>	+\$0
EK	medium red walnut <input type="checkbox"/>	+\$0
EW	medium matte walnut <input type="checkbox"/>	+\$0
ET	clear on ash <input type="checkbox"/>	+\$0
EU	oak on ash <input type="checkbox"/>	+\$0
EV	walnut on ash <input type="checkbox"/>	+\$0
UL	natural maple <input type="checkbox"/>	+\$0
UX	walnut on cherry <input type="checkbox"/>	+\$0

Step 12. Top Finish

Solid-Color Laminate

For $\frac{3}{8}$ " laminate top (03) or $1\frac{1}{4}$ " laminate top (06)

8Q	folkstone grey <input type="checkbox"/>	+\$0
91	white <input type="checkbox"/>	+\$0
98	studio white	+\$0
CL	cool grey neutral <input type="checkbox"/>	+\$0
LU	soft white <input type="checkbox"/>	+\$0
WL	sandstone <input type="checkbox"/>	+\$0
WN	warm grey neutral <input type="checkbox"/>	+\$0

Linon Laminate

For $\frac{3}{8}$ " laminate top (03) or $1\frac{1}{4}$ " laminate top (06)

LBM	crisp linon	+\$0
LBN	classic linon	+\$0
LBP	casual linon	+\$0

Mesh Laminate

For $\frac{3}{8}$ " laminate top (03) or $1\frac{1}{4}$ " laminate top (06)

LBK	pewter mesh	+\$0
LBL	steel mesh	+\$0

Twill Laminate

For $\frac{3}{8}$ " laminate top (03) or $1\frac{1}{4}$ " laminate top (06)

LBF	neutral twill	+\$0
LBG	sarum twill	+\$0
LBH	earthen twill	+\$0
LBJ	graphite twill	+\$0
LBQ	white twill	+\$0

Wood-Grain Laminate

For $\frac{3}{8}$ " laminate top (03) or $1\frac{1}{4}$ " laminate top (06)

HM	natural maple <input type="checkbox"/>	+\$0
HP	light anigre <input type="checkbox"/>	+\$0
LBA	clear on ash	+\$0
LBR	phantom ecru	+\$0
LBS	phantom cocoa	+\$0
LBU	medium matte walnut	+\$0
LBV	warm grey teak	+\$0
LBB	oak on ash	+\$0
LBC	walnut on ash	+\$0
LBD	dark brown walnut	+\$0
LBE	medium red walnut	+\$0
76	light brown walnut <input type="checkbox"/>	+\$0
HX	aged cherry <input type="checkbox"/>	+\$0
HY	walnut on cherry <input type="checkbox"/>	+\$0

Wood Veneer

For $\frac{3}{8}$ " veneer top (04) or $1\frac{1}{4}$ " veneer top (07)

2U	light brown walnut <input type="checkbox"/>	+\$0
40	dark brown walnut <input type="checkbox"/>	+\$0
ED	aged cherry <input type="checkbox"/>	+\$0
EK	medium red walnut <input type="checkbox"/>	+\$0
EW	medium matte walnut <input type="checkbox"/>	+\$0
ET	clear on ash <input type="checkbox"/>	+\$0
EU	oak on ash <input type="checkbox"/>	+\$0
EV	walnut on ash <input type="checkbox"/>	+\$0
UL	natural maple <input type="checkbox"/>	+\$0
UX	walnut on cherry <input type="checkbox"/>	+\$0

Step 13. Pull Finish

For arc pull (A.)

NH	brushed nickel <input type="checkbox"/>	+\$0
NK	black nickel <input type="checkbox"/>	+\$0

Metal High Credenza, with Doors

continued

For bar pull (K.)

8Q	folkstone grey	+\$0
91	white	+\$0
98	studio white <input type="checkbox"/> A	+\$0
G1	graphite <input type="checkbox"/> A	+\$0
WL	sandstone <input type="checkbox"/> A	+\$0
CN	metallic champagne <input type="checkbox"/> A	+\$0
MS	metallic silver <input type="checkbox"/> A	+\$0
79	green apple <input type="checkbox"/> A	+\$15
MY3	yellow oxide <input type="checkbox"/> A	+\$15
RO	red <input type="checkbox"/> A	+\$15
TRQ	turquoise <input type="checkbox"/> A	+\$15

Step 14. Lock Option

KA	keyed alike <input type="checkbox"/> A	-\$10
KC	keyed differently, chrome <input type="checkbox"/> A	+\$0
KD	keyed differently, black <input type="checkbox"/> A	+\$0

Powered Metal Low Credenza,
with Drawers

FMP72A
FMP72K

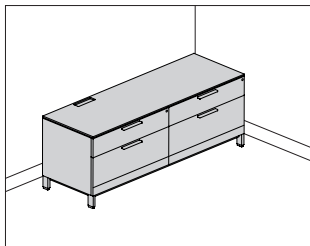

Product Information

Description

This powered credenza provides enclosed filing and storage and can be used freestanding, to support 1 end of a surface, or attached to a Canvas wall-based frame to support a frame run. It has a 3/8"-high laminate or veneer top and a painted steel case with a painted, laminate, or veneer front. The credenza is available with 4"-high architectural feet with 1" leveling glides and has a positive interlock system that permits only 1 drawer to open at a time. Drawers have full-extension ball-bearing slides. The file drawer(s) accommodate side-to-side and front-to-back filing of letter-, legal, and A4-size hanging files. Connect™ power distributors with modular ends are ordered and installed separately. Actual powered credenza widths are 59 3/4", or 71 3/4"; actual depth is 19 7/8".

Notes

For additional product options, see Vary Easy Program in Appendices.

Arc pull option (A.) conforms to guidelines of Americans with Disabilities Act (ADA).

Grain direction is vertical on veneer and wood-grain laminate fronts.

60"-and 72"-wide credenzas have 2 box drawers and 2 file drawers.

Credenza with 4"-high foot option (4) and 3/8" thin top can be used to support a Canvas wall-based frame. Order support bracket, low credenza-to-frame (FT292.) separately.

When using credenza to support 1 end of a surface, order 1 of the following products separately:

- Surface support, low credenza, adjustable height (FT299.)
- Surface support, low credenza, fixed height (FT298.)

To cover adjacent credenzas with a single top, specify credenzas with no top option (NT) and order credenza top (FM890.) separately.

To provide temporary guest seating on a credenza, order cushion top (FF891.) separately.

Order the following products separately:

- Connect - S310 electrical unit with connect modular connection (Y1329.)
- Connect - power entry, 4-circuit (Y1351.)
- Connect - junction block to junction block jumper, 4-circuit (Y1353.)
- Connect - H-block connector, 4-circuit (Y1354.H)

Powered credenzas must be ganged together.

For keyed-alike locks, see Keyed-Alike Information in Appendices.

Dimensions

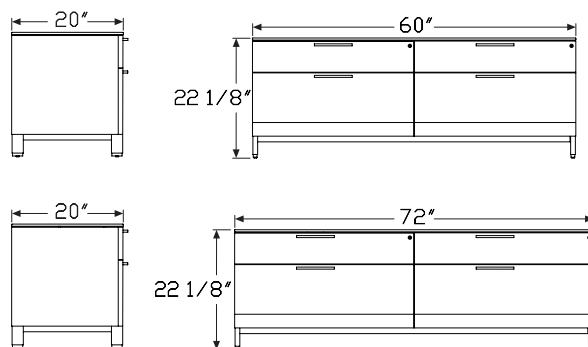

Powered Metal Low Credenza,
with Drawers *continued*

Canvas Office Landscape® Metal Case Credenzas

Specification Information							
Step 1.							
FMP72	A						
Step 2. Pull Type							
A.	arc pull	A					
K.	bar pull	A					
Step 3. Width							
60	60" wide	A					
72	72" wide	A					
Step 4. Depth							
20	20" deep	A					
Step 5. Base/Foot Height							
4	4"-high foot	A					
Step 6. Configuration							
BF	box/file	A					
Step 7. Front Material							
P	painted metal front	A					
L	laminate front	A					
W	vener front	A					
Step 8. Top							
<i>For painted metal front (P) or laminate front (L)</i>							
NT	no top	A					
03	3/8" laminate top	A					
04	3/8" veneer top	A					
<i>For veneer front (W)</i>							
NT	no top	A					
04	3/8" veneer top	A					
Step 9. Power Access Location							
L	left center access	A					
R	right center access	A					
Step 10. Lock							
L	lock	A					
Prices for Steps 1-10.							
		4BFPNTLL	4BFPNTRL	4BFP03LL	4BFP03RL	4BFP04LL	4BFP04RL
FMP72A. 60 20		\$3222	3222	3336	3336	3562	3562

	72 20	\$3554	3554	3668	3668	3895	3895
		4BFLNLLL	4BFLNTRL	4BFL03LL	4BFL03RL	4BFL04LL	4BFL04RL
FMP72A. 60 20		\$3425	3425	3540	3540	3765	3765
	72 20	\$3759	3759	3871	3871	4097	4097
		4BFWNTLL	4BFWNTRL	4BFW04LL	4BFW04RL		
FMP72A. 60 20		\$4371	4371	4642	4642		
	72 20	\$4735	4735	5073	5073		
		4BFPNTLL	4BFPNTRL	4BFP03LL	4BFP03RL	4BFP04LL	4BFP04RL
FMP72K. 60 20		\$3222	3222	3336	3336	3562	3562
	72 20	\$3663	3554	3668	3668	3993	3895
		4BFLNLLL	4BFLNTRL	4BFL03LL	4BFL03RL	4BFL04LL	4BFL04RL
FMP72K. 60 20		\$3425	3425	3528	3540	3765	3765
	72 20	\$3759	3759	3871	3871	4316	4097
		4BFWNTLL	4BFWNTRL	4BFW04LL	4BFW04RL		
FMP72K. 60 20		\$4371	4371	4642	4642		
	72 20	\$4735	4735	5128	5073		
Step 11. Paint/Steel Type							
SS	smooth paint on smooth steel	A					+\$0
XS	textured paint on smooth steel	A					+\$0
Step 12. Surface Finish							
Metallic Paint							
<i>For smooth paint on smooth steel (SS)</i>							
CN	metallic champagne	A					+\$0
EH	metallic bronze	A					+\$0
MS	metallic silver	A					+\$0
Sand Texture Paint							
<i>For textured paint on smooth steel (XS)</i>							
98	studio white	A					+\$0
8Q	folkstone grey	A					+\$0
WL	sandstone	A					+\$0
Bright Sand Texture Paint							
<i>For textured paint on smooth steel (XS)</i>							
91	white	A					+\$0
CL	cool grey neutral	A					+\$0
G1	graphite	A					+\$0
WN	warm grey neutral	A					+\$0

Powered Metal Low Credenza, with Drawers *continued*

Step 13. Front Finish

Solid-Color Laminate

For laminate front (L)

8Q	folkstone grey <input type="checkbox"/>	+\$0
91	white <input type="checkbox"/>	+\$0
98	studio white	+\$0
CL	cool grey neutral <input type="checkbox"/>	+\$0
LU	soft white <input type="checkbox"/>	+\$0
WL	sandstone <input type="checkbox"/>	+\$0
WN	warm grey neutral <input type="checkbox"/>	+\$0

Linen Laminate

For laminate front (L)

LBM	crisp linen	+\$0
LBN	classic linen	+\$0
LBP	casual linen	+\$0

Mesh Laminate

For laminate front (L)

LBK	pewter mesh	+\$0
LBL	steel mesh	+\$0

Twill Laminate

For laminate front (L)

LBF	neutral twill	+\$0
LBG	sarum twill	+\$0
LBH	earthen twill	+\$0
LBJ	graphite twill	+\$0
LBQ	white twill	+\$0

Wood-Grain Laminate

For laminate front (L)

HM	natural maple <input type="checkbox"/>	+\$0
HP	light anigre <input type="checkbox"/>	+\$0
LBA	clear on ash	+\$0
LBR	phantom ecru	+\$0
LBS	phantom cocoa	+\$0
LBU	medium matte walnut	+\$0
LBV	warm grey teak	+\$0
LBB	oak on ash	+\$0
LBC	walnut on ash	+\$0
LBD	dark brown walnut	+\$0
LBE	medium red walnut	+\$0
76	light brown walnut <input type="checkbox"/>	+\$0
HX	aged cherry <input type="checkbox"/>	+\$0
HY	walnut on cherry <input type="checkbox"/>	+\$0

Wood Veneer

For veneer front (W)

2U	light brown walnut <input type="checkbox"/>	+\$0
40	dark brown walnut <input type="checkbox"/>	+\$0
ED	aged cherry <input type="checkbox"/>	+\$0
EK	medium red walnut <input type="checkbox"/>	+\$0
EW	medium matte walnut <input type="checkbox"/>	+\$0
ET	clear on ash <input type="checkbox"/>	+\$0
EV	walnut on ash <input type="checkbox"/>	+\$0
UL	natural maple <input type="checkbox"/>	+\$0
UX	walnut on cherry <input type="checkbox"/>	+\$0

Step 14. Top Finish

Solid-Color Laminate

For 3/8" laminate top (O3)

8Q	folkstone grey <input type="checkbox"/>	+\$0
91	white <input type="checkbox"/>	+\$0
98	studio white	+\$0
CL	cool grey neutral <input type="checkbox"/>	+\$0
LU	soft white <input type="checkbox"/>	+\$0
WL	sandstone <input type="checkbox"/>	+\$0
WN	warm grey neutral <input type="checkbox"/>	+\$0

Linen Laminate

For 3/8" laminate top (O3)

LBM	crisp linen	+\$0
LBN	classic linen	+\$0
LBP	casual linen	+\$0

Mesh Laminate

For 3/8" laminate top (O3)

LBK	pewter mesh	+\$0
LBL	steel mesh	+\$0

Twill Laminate

For 3/8" laminate top (O3)

LBF	neutral twill	+\$0
LBG	sarum twill	+\$0
LBH	earthen twill	+\$0
LBJ	graphite twill	+\$0
LBQ	white twill	+\$0

Powered Metal Low Credenza, with Drawers *continued*

Wood-Grain Laminate

For ³/₈" laminate top (03)

HM	natural maple <input type="checkbox"/>	+\$0
HP	light anigre <input type="checkbox"/>	+\$0
LBA	clear on ash	+\$0
LBR	phantom ecru	+\$0
LBS	phantom cocoa	+\$0
LBU	medium matte walnut	+\$0
LBV	warm grey teak	+\$0
LBB	oak on ash	+\$0
LBC	walnut on ash	+\$0
LBD	dark brown walnut	+\$0
LBE	medium red walnut	+\$0
76	light brown walnut <input type="checkbox"/>	+\$0
HX	aged cherry <input type="checkbox"/>	+\$0
HY	walnut on cherry <input type="checkbox"/>	+\$0

Wood Veneer

For ³/₈" veneer top (04)

2U	light brown walnut <input type="checkbox"/>	+\$0
40	dark brown walnut <input type="checkbox"/>	+\$0
ED	aged cherry <input type="checkbox"/>	+\$0
EK	medium red walnut <input type="checkbox"/>	+\$0
EW	medium matte walnut <input type="checkbox"/>	+\$0
ET	clear on ash <input type="checkbox"/>	+\$0
EV	walnut on ash <input type="checkbox"/>	+\$0
UL	natural maple <input type="checkbox"/>	+\$0
UX	walnut on cherry <input type="checkbox"/>	+\$0

Step 15. Base Finish

8Q	folkstone grey <input type="checkbox"/>	+\$0
98	studio white <input type="checkbox"/>	+\$0
WL	sandstone <input type="checkbox"/>	+\$0

Bright Sand Texture Paint

91	white <input type="checkbox"/>	+\$0
CL	cool grey neutral <input type="checkbox"/>	+\$0
G1	graphite <input type="checkbox"/>	+\$0
WN	warm grey neutral <input type="checkbox"/>	+\$0

Metallic Paint

CN	metallic champagne <input type="checkbox"/>	+\$0
EH	metallic bronze <input type="checkbox"/>	+\$0
MS	metallic silver <input type="checkbox"/>	+\$0

Step 16. Pull Finish

For arc pull (A.)

NH	brushed nickel <input type="checkbox"/>	+\$0
NK	black nickel <input type="checkbox"/>	+\$0

For bar pull (K.)

8Q	folkstone grey	+\$0
91	white	+\$0
98	studio white <input type="checkbox"/>	+\$0
G1	graphite <input type="checkbox"/>	+\$0
WL	sandstone <input type="checkbox"/>	+\$0
CN	metallic champagne <input type="checkbox"/>	+\$0
MS	metallic silver <input type="checkbox"/>	+\$0
79	green apple <input type="checkbox"/>	+\$15
MY3	yellow oxide <input type="checkbox"/>	+\$15
RO	red <input type="checkbox"/>	+\$15
TRQ	turquoise <input type="checkbox"/>	+\$15

Step 17. Counterweight

NO	no counterweight <input type="checkbox"/>	+\$0
CB	counterweight <input type="checkbox"/>	+\$115

Step 18. Lock Option

KA	keyed alike <input type="checkbox"/>	-\$10
KC	keyed differently, chrome <input type="checkbox"/>	+\$0
KD	keyed differently, black <input type="checkbox"/>	+\$0

Powered Metal Low Credenza,
Open with Drawers

FMP73A
FMP73K

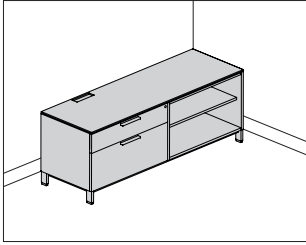

Product Information

Description

This powered credenza provides drawer storage on 1 side with open storage on the other side and can be used freestanding, to support 1 end of a surface, or attached to a Canvas wall-based frame to support a frame run. It has a 3/8"-high laminate or veneer top and a painted steel case with a painted, laminate, or veneer front. The credenza is available with 4"-high architectural feet with 1" leveling glides and has a positive interlock system that permits only 1 drawer to open at a time. Drawers have full-extension ball-bearing slides. The file drawer(s) accommodate side-to-side and front-to-back filing of letter-, legal, and A4-size hanging files. Connect™ power distributors with modular ends are ordered and installed separately.

Actual powered credenza widths are 47 3/4", 59 3/4", 65 3/4", or 71 3/4"; actual depth is 19 7/8".

Notes

For additional product options, see Vary Easy Program in Appendices. Arc pull option (A.) conforms to guidelines of Americans with Disabilities Act (ADA).

Grain direction is vertical on veneer and wood-grain laminate fronts. Open side of credenza includes 1 adjustable shelf that adjusts in 1/4" increments.

Credenza with 4"-high foot option (4) and 3/8" thin top can be used to support a Canvas wall-based frame. Order support bracket, low credenza-to-frame (FT292.) separately.

When using credenza to support 1 end of a surface, order 1 of the following products separately:

- Surface support, low credenza, adjustable height (FT299.)
- Surface support, low credenza, fixed height (FT298.)

To cover adjacent credenzas with a single top, specify credenzas with no top option (NT) and order credenza top (FM890.) separately.

Order optional metal credenza shelf (FM892.) separately.

To provide temporary guest seating on a credenza, order cushion top (FF891.) separately.

Order the following products separately:

- Connect - S310 electrical unit with connect modular connection (Y1329.)
- Connect - power entry, 4-circuit (Y1351.)
- Connect - junction block to junction block jumper, 4-circuit (Y1353.)
- Connect - H-block connector, 4-circuit (Y1354.H)

Powered credenzas must be ganged together.

For keyed-alike locks, see Keyed-Alike Information in Appendices.

Dimensions

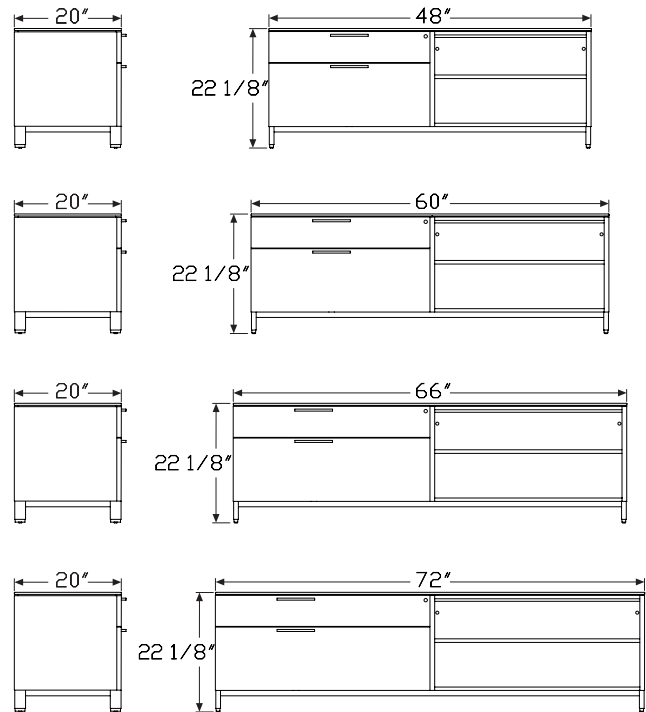

Canvas Office Landscape® Metal Case Credenzas

Powered Metal Low Credenza, Open with Drawers *continued*

Specification Information

Step 1.

FMP73 A

Step 2. Pull Type

- A.** arc pull A
- K.** bar pull A

Step 3. Width

- 48** 48" wide A
- 60** 60" wide A
- 66** 66" wide A
- 72** 72" wide A

Step 4. Depth

- 20** 20" deep A

Step 5. Base/Foot Height

- 4** 4"-high foot A

Step 6. Configuration

For 48" wide (48)

- AA** 30" box/file left, open right A
- AB** open left, 30" box/file right A

For 60" wide (60)

- AA** 30" box/file left, open right A
- AB** open left, 30" box/file right A
- AC** 36" box/file left, open right A
- AD** open left, 36" box/file right A

For 66" wide (66) or 72" wide (72)

- AC** 36" box/file left, open right A
- AD** open left, 36" box/file right A
- AE** 42" box/file left, open right A
- AF** open left, 42" box/file right A

Step 7. Front Material

- P** painted metal front A
- L** laminate front A
- W** veneer front A

Step 8. Top

For painted metal front (P) or laminate front (L)

- NT** no top A
- 03** 3/8" laminate top A
- 04** 3/8" veneer top A

For veneer front (W)

- NT** no top A
- 04** 3/8" veneer top A

Step 9. Top Power Access Location

- L** left center access A
- R** right center access A

Step 10. Inside Power Access Location

- N** no access A
- A** power access inside of credenza A

Step 11. Lock

- L** lock A

Prices for Steps 1-11.

	4AAPNTLNL	4AAPNTLAL	4AAPNTRNL	4AAPNTRAL	4AAP03LNL	4AAP03LAL
FMP73A. 48 20	\$2675	2704	2675	2704	2790	2817
60 20	\$2883	2912	2883	2912	2998	3026
	4AAP03RNL	4AAP03RAL	4AAP04LNL	4AAP04LAL	4AAP04RNL	4AAP04RAL
FMP73A. 48 20	\$2790	2817	3016	3042	3016	3042
60 20	\$2998	3026	3224	3251	3224	3251
	4AALNTLNL	4AALNTLAL	4AALNTRNL	4AALNTRAL	4AAL03LNL	4AAL03LAL
FMP73A. 48 20	\$2834	2863	2834	2863	2947	2975
60 20	\$3055	3083	3055	3083	3170	3197
	4AAL03RNL	4AAL03RAL	4AAL04LNL	4AAL04LAL	4AAL04RNL	4AAL04RAL
FMP73A. 48 20	\$2947	2975	3175	3201	3175	3201
60 20	\$3170	3197	3396	3423	3396	3423
	4AAWNTLNL	4AAWNTLAL	4AAWNTRNL	4AAWNTRAL	4AAW04LNL	4AAW04LAL
FMP73A. 48 20	\$3401	3427	3401	3427	3740	3767
60 20	\$3710	3737	3710	3737	4049	4076
	4AAW04RNL	4AAW04RAL	4ABPNTLNL	4ABPNTLAL	4ABPNTRNL	4ABPNTRAL
FMP73A. 48 20	\$3740	3767	2675	2704	2675	2704
60 20	\$4049	4076	2883	2912	2883	2912

Powered Metal Low Credenza,
Open with Drawers *continued*

	4ABP03LNL	4ABP03LAL	4ABP03RNL	4ABP03RAL	4ABP04LNL	4ABP04LAL
FMP73A. 48 20	\$2790	2817	2790	2817	3016	3042
60 20	\$2998	3026	2998	3026	3224	3251
	4ABP04RNL	4ABP04RAL	4ABLNTLNL	4ABLNTLAL	4ABLNRNL	4ABLNRAL
FMP73A. 48 20	\$3016	3042	2834	2863	2834	2863
60 20	\$3224	3251	3055	3083	3055	3083
	4ABLO3LNL	4ABLO3LAL	4ABLO3RNL	4ABLO3RAL	4ABLO4LNL	4ABLO4LAL
FMP73A. 48 20	\$2947	2975	2947	2975	3175	3201
60 20	\$3170	3197	3170	3197	3396	3423
	4ABLO4RNL	4ABLO4RAL	4ABWNTLNL	4ABWNTLAL	4ABWNRNL	4ABWNRAL
FMP73A. 48 20	\$3175	3201	3401	3427	3401	3427
60 20	\$3396	3423	3710	3737	3710	3737
	4ABW04LNL	4ABW04LAL	4ABW04RNL	4ABW04RAL	4ACPNTLNL	4ACPNTLAL
FMP73A. 48 20	\$3740	3767	3740	3767	—	—
60 20	\$4049	4076	4049	4076	3024	3050
66 20	—	—	—	—	\$2980	3008
72 20	—	—	—	—	\$3013	3039
	4ACPNRNL	4ACPNRAL	4ACP03LNL	4ACP03LAL	4ACP03RNL	4ACP03RAL
FMP73A. 60 20	\$2952	2979	3137	3165	3067	3093
66 20	\$2980	3008	3094	3122	3094	3122
72 20	\$3024	3050	3137	3165	3137	3165
	4ACP04LNL	4ACP04LAL	4ACP04RNL	4ACP04RAL	4ACLNTLNL	4ACLNTLAL
FMP73A. 60 20	\$3292	3319	3292	3319	3140	3168
66 20	\$3320	3348	3320	3348	3160	3187
72 20	\$3362	3390	3362	3390	3204	3233
	4ACLNRNL	4ACLNRAL	4ACLO3LNL	4ACLO3LAL	4ACLO3RNL	4ACLO3RAL
FMP73A. 60 20	\$3140	3168	3242	3269	3242	3269
66 20	\$3160	3187	3273	3300	3273	3300
72 20	\$3204	3233	3317	3345	3317	3345
	4ACLO4LNL	4ACLO4LAL	4ACLO4RNL	4ACLO4RAL	4ACWNTLNL	4ACWNTLAL
FMP73A. 60 20	\$3479	3507	3479	3507	3800	3827
66 20	\$3498	3526	3498	3526	3948	3975
72 20	\$3544	3570	3544	3570	4016	4043
	4ACWNRNL	4ACWNRAL	4ACW04LNL	4ACW04LAL	4ACW04RNL	4ACW04RAL
FMP73A. 60 20	\$3800	3827	4140	4168	4140	4168
66 20	\$3948	3975	4286	4314	4286	4314
72 20	\$4016	4043	4356	4384	4356	4384

	4AEPNTLNL	4AEPNTLAL	4AEPNRNL	4AEPNRAL	4AEP03LNL	4AEP03LAL
FMP73A. 66 20	\$3078	3105	3078	3105	3192	3220
72 20	\$3123	3149	3123	3149	3237	3264
	4AEP03RNL	4AEP03RAL	4AEP04LNL	4AEP04LAL	4AEP04RNL	4AEP04RAL
FMP73A. 66 20	\$3192	3220	3418	3445	3418	3445
72 20	\$3237	3264	3462	3490	3462	3490
	4AELNTLNL	4AELNTLAL	4AELNRNL	4AELNRAL	4AEL03LNL	4AEL03LAL
FMP73A. 66 20	\$3263	3290	3263	3290	3375	3403
72 20	\$3309	3338	3309	3338	3423	3451
	4AEL03RNL	4AEL03RAL	4AEL04LNL	4AEL04LAL	4AEL04RNL	4AEL04RAL
FMP73A. 66 20	\$3375	3403	3601	3629	3601	3629
72 20	\$3423	3451	3650	3677	3650	3677
	4AEWNTLNL	4AEWNTLAL	4AEWNRNL	4AEWNRAL	4AEW04LNL	4AEW04LAL
FMP73A. 66 20	\$4031	4059	4031	4059	4370	4398
72 20	\$4031	4059	4180	4208	4370	4398
	4AEW04RNL	4AEW04RAL	4ADPNTLNL	4ADPNTLAL	4ADPNRNL	4ADPNRAL
FMP73A. 60 20	—	—	\$2952	2979	2952	2979
66 20	\$4370	4398	2980	3008	2980	3008
72 20	\$4475	4502	3013	3039	3024	3050
	4ADP03LNL	4ADP03LAL	4ADP03RNL	4ADP03RAL	4ADP04LNL	4ADP04LAL
FMP73A. 60 20	\$3067	3093	3067	3093	3292	3319
66 20	\$3094	3122	3094	3122	3320	3348
72 20	\$3137	3165	3137	3165	3362	3390
	4ADP04RNL	4ADP04RAL	4ADLNTLNL	4ADLNTLAL	4ADLNRNL	4ADLNRAL
FMP73A. 60 20	\$3292	3319	3140	3168	3140	3168
66 20	\$3320	3348	3160	3187	3160	3187
72 20	\$3362	3390	3204	3233	3204	3233
	4ADLO3LNL	4ADLO3LAL	4ADLO3RNL	4ADLO3RAL	4ADLO4LNL	4ADLO4LAL
FMP73A. 60 20	\$3242	3269	3242	3269	3479	3507
66 20	\$3273	3300	3273	3300	3498	3526
72 20	\$3317	3345	3317	3345	3544	3570
	4ADLO4RNL	4ADLO4RAL	4ADWNTLNL	4ADWNTLAL	4ADWNRNL	4ADWNRAL
FMP73A. 60 20	\$3479	3507	3800	3827	3800	3827
66 20	\$3498	3526	3948	3975	3948	3975
72 20	\$3544	3570	4016	4043	4016	4043
	4ADW04LNL	4ADW04LAL	4ADW04RNL	4ADW04RAL	4AFPNTLNL	4AFPNTLAL
FMP73A. 60 20	\$4140	4168	4140	4168	—	—

Powered Metal Low Credenza,
Open with Drawers *continued*

Canvas Office Landscape® Metal Case Credenzas

	66 20	\$4286	4314	4286	4314	3078	3105
	72 20	\$4356	4384	4356	4384	3123	3149
		4AFPNTLNL	4AFPNTLAL	4AFP03LNL	4AFP03LAL	4AFP03RNL	4AFP03RAL
FMP73A.	66 20	\$3078	3105	3192	3220	3192	3220
	72 20	\$3123	3149	3237	3264	3237	3264
		4AFP04LNL	4AFP04LAL	4AFP04RNL	4AFP04RAL	4AFLNLTNL	4AFLNLTAL
FMP73A.	66 20	\$3418	3445	3418	3445	3263	3290
	72 20	\$3462	3490	3462	3490	3309	3338
		4AFLNTRNL	4AFLNTRAL	4AFL03LNL	4AFL03LAL	4AFL03RNL	4AFL03RAL
FMP73A.	66 20	\$3263	3290	3375	3403	3375	3403
	72 20	\$3309	3338	3423	3451	3423	3451
		4AFL04LNL	4AFL04LAL	4AFL04RNL	4AFL04RAL	4AFWNTLNL	4AFWNTLAL
FMP73A.	66 20	\$3601	3629	3601	3629	4031	4059
	72 20	\$3650	3677	3650	3677	4180	4208
		4AFWNTLNL	4AFWNTLAL	4AFW04LNL	4AFW04LAL	4AFW04RNL	4AFW04RAL
FMP73A.	66 20	\$4031	4059	4370	4398	4370	4398
	72 20	\$4180	4208	4475	4502	4475	4502
		4AAPNTLNL	4AAPNTLAL	4AAPNTRNL	4AAPNTRAL	4AAP03LNL	4AAP03LAL
FMP73K.	48 20	\$2675	2675	2704	2704	2790	2790
	60 20	\$2883	2912	2883	2912	2998	3026
		4AAP03RNL	4AAP03RAL	4AAP04LNL	4AAP04LAL	4AAP04RNL	4AAP04RAL
FMP73K.	48 20	\$2817	2817	3016	3016	3042	3042
	60 20	\$2998	3026	3224	3251	3224	3251
		4AALNLTNL	4AALNLTAL	4AALNTRNL	4AALNTRAL	4AAL03LNL	4AAL03LAL
FMP73K.	48 20	\$2834	2834	2863	2863	2947	2947
	60 20	\$3055	3083	3055	3083	3170	3197
		4AAL03RNL	4AAL03RAL	4AAL04LNL	4AAL04LAL	4AAL04RNL	4AAL04RAL
FMP73K.	48 20	\$2975	2975	3175	3175	3201	3201
	60 20	\$3170	3197	3396	3423	3396	3423
		4AAWNTLNL	4AAWNTLAL	4AAWNTLNL	4AAWNTLAL	4AAW04LNL	4AAW04LAL
FMP73K.	48 20	\$3401	3401	3427	3427	3740	3740
	60 20	\$3710	3737	3710	3737	4049	4076
		4AAW04RNL	4AAW04RAL	4ABPNTLNL	4ABPNTLAL	4ABPNTRNL	4ABPNTRAL
FMP73K.	48 20	\$3767	3767	2675	2675	2704	2704
	60 20	\$4049	4076	3055	2912	2883	2912

		4ABP03LNL	4ABP03LAL	4ABP03RNL	4ABP03RAL	4ABP04LNL	4ABP04LAL
FMP73K.	48 20	\$2790	2790	2817	2817	3016	3016
	60 20	\$2998	3026	2998	3026	3224	3251
		4ABP04RNL	4ABP04RAL	4ABLNTLNL	4ABLNTLAL	4ABLNTRNL	4ABLNTRAL
FMP73K.	48 20	\$3042	3042	2834	2834	2863	2863
	60 20	\$3224	3251	2883	3083	3055	3083
		4ABL03LNL	4ABL03LAL	4ABL03RNL	4ABL03RAL	4ABL04LNL	4ABL04LAL
FMP73K.	48 20	\$2947	2947	2975	2975	3175	3175
	60 20	\$3170	3197	3170	3197	3163	3423
		4ABL04RNL	4ABL04RAL	4ABWNTLNL	4ABWNTLAL	4ABWNTRNL	4ABWNTRAL
FMP73K.	48 20	\$3201	3201	3401	3401	3427	3427
	60 20	\$3396	3423	3710	3737	3710	3737
		4ABW04LNL	4ABW04LAL	4ABW04RNL	4ABW04RAL	4ACPNTLNL	4ACPNTLAL
FMP73K.	48 20	\$3740	3740	3767	3767	—	—
	60 20	\$4049	4076	4049	4076	3024	3050
	66 20	—	—	—	—	\$2980	3008
	72 20	—	—	—	—	\$3013	3039
		4ACPNTLNL	4ACPNTLAL	4ACP03LNL	4ACP03LAL	4ACP03RNL	4ACP03RAL
FMP73K.	60 20	\$2952	2979	3137	3165	3067	3093
	66 20	\$2980	3008	3094	3122	3094	3122
	72 20	\$3024	3050	3137	3165	3137	3165
		4ACP04LNL	4ACP04LAL	4ACP04RNL	4ACP04RAL	4ACLNTLNL	4ACLNTLAL
FMP73K.	60 20	\$3292	3319	3292	3319	3140	3168
	66 20	\$3320	3348	3320	3348	3160	3187
	72 20	\$3362	3390	3362	3390	3204	3233
		4ACLNTRNL	4ACLNTRAL	4ACL03LNL	4ACL03LAL	4ACL03RNL	4ACL03RAL
FMP73K.	60 20	\$3140	3168	3242	3269	3242	3269
	66 20	\$3160	3187	3273	3300	3273	3300
	72 20	\$3204	3233	3317	3345	3317	3345
		4ACL04LNL	4ACL04LAL	4ACL04RNL	4ACL04RAL	4ACWNTLNL	4ACWNTLAL
FMP73K.	60 20	\$3479	3507	3479	3507	3800	3827
	66 20	\$3498	3526	3498	3526	3948	3975
	72 20	\$3544	3570	3544	3570	4016	4043
		4ACWNTLNL	4ACWNTLAL	4ACW04LNL	4ACW04LAL	4ACW04RNL	4ACW04RAL
FMP73K.	60 20	\$3800	3827	4140	4168	4140	4168
	66 20	\$3948	3975	4286	4314	4286	4314
	72 20	\$4016	4043	4356	4384	4356	4384

Powered Metal Low Credenza,
Open with Drawers *continued*

	4AEPNTLNL	4AEPNTLAL	4AEPNTRNL	4AEPNTRAL	4AEP03LNL	4AEP03LAL
FMP73K. 66 20	\$3078	3105	3078	3105	3192	3220
72 20	\$3123	3149	3123	3149	3237	3264
	4AEP03RNL	4AEP03RAL	4AEP04LNL	4AEP04LAL	4AEP04RNL	4AEP04RAL
FMP73K. 66 20	\$3192	3220	3418	3445	3418	3445
72 20	\$3237	3264	3462	3490	3462	3490
	4AELNTRLNL	4AELNTRLAL	4AELNTRNL	4AELNTRAL	4AEL03LNL	4AEL03LAL
FMP73K. 66 20	\$3263	3290	3263	3290	3375	3403
72 20	\$3309	3338	3309	3338	3423	3451
	4AEL03RNL	4AEL03RAL	4AEL04LNL	4AEL04LAL	4AEL04RNL	4AEL04RAL
FMP73K. 66 20	\$3375	3403	3601	3629	3601	3629
72 20	\$3423	3451	3650	3677	3650	3677
	4AEWNTLNL	4AEWNTLAL	4AEWNTRNL	4AEWNTRAL	4AEW04LNL	4AEW04LAL
FMP73K. 66 20	\$4031	4059	4031	4059	4370	4398
72 20	\$4031	4059	4180	4208	4370	4398
	4AEW04RNL	4AEW04RAL	4ADPNTLNL	4ADPNTLAL	4ADPNTRNL	4ADPNTRAL
FMP73K. 60 20	—	—	\$2952	2979	2952	2979
66 20	\$4370	4398	2980	3008	2980	3008
72 20	\$4475	4502	3013	3039	3024	3050
	4ADP03LNL	4ADP03LAL	4ADP03RNL	4ADP03RAL	4ADP04LNL	4ADP04LAL
FMP73K. 60 20	\$3067	3093	3067	3093	3292	3319
66 20	\$3094	3122	3094	3122	3320	3348
72 20	\$3137	3165	3137	3165	3362	3390
	4ADP04RNL	4ADP04RAL	4ADLNTLNL	4ADLNTLAL	4ADLNTRNL	4ADLNTRAL
FMP73K. 60 20	\$3292	3319	3140	3168	3140	3168
66 20	\$3320	3348	3160	3187	3160	3187
72 20	\$3362	3390	3204	3233	3204	3233
	4ADL03LNL	4ADL03LAL	4ADL03RNL	4ADL03RAL	4ADL04LNL	4ADL04LAL
FMP73K. 60 20	\$3242	3269	3242	3269	3479	3507
66 20	\$3273	3300	3273	3300	3498	3526
72 20	\$3317	3345	3317	3345	3544	3570
	4ADL04RNL	4ADL04RAL	4ADWNTLNL	4ADWNTLAL	4ADWNTRNL	4ADWNTRAL
FMP73K. 60 20	\$3479	3507	3800	3827	3800	3827
66 20	\$3498	3526	3948	3975	3948	3975
72 20	\$3544	3570	4016	4043	4016	4043
	4ADW04LNL	4ADW04LAL	4ADW04RNL	4ADW04RAL	4AFPNTLNL	4AFPNTLAL
FMP73K. 60 20	\$4140	4168	4140	4168	—	—

66 20	\$4286	4314	4286	4314	3078	3105
72 20	\$4356	4384	4356	4384	3123	3149
	4AFPNTRNL	4AFPNTRAL	4AFP03LNL	4AFP03LAL	4AFP03RNL	4AFP03RAL
FMP73K. 66 20	\$3078	3105	3192	3220	3192	3220
72 20	\$3123	3149	3237	3264	3237	3264
	4AFP04LNL	4AFP04LAL	4AFP04RNL	4AFP04RAL	4AFLNTRLNL	4AFLNTRLAL
FMP73K. 66 20	\$3418	3445	3418	3445	3263	3290
72 20	\$3462	3490	3462	3490	3309	3338
	4AFLNTRNL	4AFLNTRAL	4AFL03LNL	4AFL03LAL	4AFL03RNL	4AFL03RAL
FMP73K. 66 20	\$3263	3290	3375	3403	3375	3403
72 20	\$3309	3338	3423	3451	3423	3451
	4AFL04LNL	4AFL04LAL	4AFL04RNL	4AFL04RAL	4AFWNTLNL	4AFWNTLAL
FMP73K. 66 20	\$3601	3629	3601	3629	4031	4059
72 20	\$3650	3677	3650	3677	4180	4208
	4AFWNTRNL	4AFWNTRAL	4AFW04LNL	4AFW04LAL	4AFW04RNL	4AFW04RAL
FMP73K. 66 20	\$4031	4059	4370	4398	4370	4398
72 20	\$4180	4208	4475	4502	4475	4502

Step 12. Paint/Steel Type

SS	smooth paint on smooth steel	A	+\$0
XS	textured paint on smooth steel	A	+\$0

Step 13. Surface Finish

Metallic Paint

For smooth paint on smooth steel (SS)

CN	metallic champagne	A	+\$0
EH	metallic bronze	A	+\$0
MS	metallic silver	A	+\$0

Sand Texture Paint

For textured paint on smooth steel (XS)

98	studio white	A	+\$0
8Q	folkstone grey	A	+\$0
WL	sandstone	A	+\$0

Bright Sand Texture Paint

For textured paint on smooth steel (XS)

91	white	A	+\$0
CL	cool grey neutral	A	+\$0
G1	graphite	A	+\$0
WN	warm grey neutral	A	+\$0

Powered Metal Low Credenza, Open with Drawers *continued*

Step 14. Front Finish

Solid-Color Laminate		
<i>For laminate front (L)</i>		
8Q	folkstone grey A	+\$0
91	white A	+\$0
98	studio white	+\$0
CL	cool grey neutral A	+\$0
LU	soft white A	+\$0
WL	sandstone A	+\$0
WN	warm grey neutral A	+\$0

Linen Laminate		
<i>For laminate front (L)</i>		
LBM	crisp linen	+\$0
LBN	classic linen	+\$0
LBP	casual linen	+\$0

Mesh Laminate		
<i>For laminate front (L)</i>		
LBK	pewter mesh	+\$0
LBL	steel mesh	+\$0

Twill Laminate		
<i>For laminate front (L)</i>		
LBF	neutral twill	+\$0
LBG	sarum twill	+\$0
LBH	earthen twill	+\$0
LBJ	graphite twill	+\$0
LBQ	white twill	+\$0

Wood-Grain Laminate		
<i>For laminate front (L)</i>		
HM	natural maple A	+\$0
HP	light anigre A	+\$0
LBA	clear on ash	+\$0
LBR	phantom ecru	+\$0
LBS	phantom cocoa	+\$0
LBU	medium matte walnut	+\$0
LBV	warm grey teak	+\$0
LBB	oak on ash	+\$0
LBC	walnut on ash	+\$0
LBD	dark brown walnut	+\$0
LBE	medium red walnut	+\$0
76	light brown walnut A	+\$0
HX	aged cherry A	+\$0
HY	walnut on cherry A	+\$0

Wood Veneer		
<i>For veneer front (W)</i>		
2U	light brown walnut A	+\$0
40	dark brown walnut A	+\$0
ED	aged cherry A	+\$0
EK	medium red walnut A	+\$0
EW	medium matte walnut A	+\$0
ET	clear on ash A	+\$0
EV	walnut on ash A	+\$0
UL	natural maple A	+\$0
UX	walnut on cherry A	+\$0

Step 15. Top Finish

Solid-Color Laminate		
<i>For ³/₈" laminate top (O3)</i>		
8Q	folkstone grey A	+\$0
91	white A	+\$0
98	studio white	+\$0
CL	cool grey neutral A	+\$0
LU	soft white A	+\$0
WL	sandstone A	+\$0
WN	warm grey neutral A	+\$0

Linen Laminate		
<i>For ³/₈" laminate top (O3)</i>		
LBM	crisp linen	+\$0
LBN	classic linen	+\$0
LBP	casual linen	+\$0

Mesh Laminate		
<i>For ³/₈" laminate top (O3)</i>		
LBK	pewter mesh	+\$0
LBL	steel mesh	+\$0

Twill Laminate		
<i>For ³/₈" laminate top (O3)</i>		
LBF	neutral twill	+\$0
LBG	sarum twill	+\$0
LBH	earthen twill	+\$0
LBJ	graphite twill	+\$0
LBQ	white twill	+\$0

Powered Metal Low Credenza, Open with Drawers *continued*

Wood-Grain Laminate

For $\frac{3}{8}$ " laminate top (03)

HM	natural maple <input type="checkbox"/>	+\$0
HP	light anigre <input type="checkbox"/>	+\$0
LBA	clear on ash	+\$0
LBR	phantom ecru	+\$0
LBS	phantom cocoa	+\$0
LBU	medium matte walnut	+\$0
LBV	warm grey teak	+\$0
LBB	oak on ash	+\$0
LBC	walnut on ash	+\$0
LBD	dark brown walnut	+\$0
LBE	medium red walnut	+\$0
76	light brown walnut <input type="checkbox"/>	+\$0
HX	aged cherry <input type="checkbox"/>	+\$0
HY	walnut on cherry <input type="checkbox"/>	+\$0

Wood Veneer

For $\frac{3}{8}$ " veneer top (04)

2U	light brown walnut <input type="checkbox"/>	+\$0
40	dark brown walnut <input type="checkbox"/>	+\$0
ED	aged cherry <input type="checkbox"/>	+\$0
EK	medium red walnut <input type="checkbox"/>	+\$0
EW	medium matte walnut <input type="checkbox"/>	+\$0
ET	clear on ash <input type="checkbox"/>	+\$0
EV	walnut on ash <input type="checkbox"/>	+\$0
UL	natural maple <input type="checkbox"/>	+\$0
UX	walnut on cherry <input type="checkbox"/>	+\$0

Step 16. Base Finish

8Q	folkstone grey <input type="checkbox"/>	+\$0
98	studio white <input type="checkbox"/>	+\$0
WL	sandstone <input type="checkbox"/>	+\$0

Bright Sand Texture Paint

91	white <input type="checkbox"/>	+\$0
CL	cool grey neutral <input type="checkbox"/>	+\$0
G1	graphite <input type="checkbox"/>	+\$0
WN	warm grey neutral <input type="checkbox"/>	+\$0

Metallic Paint

CN	metallic champagne <input type="checkbox"/>	+\$0
EH	metallic bronze <input type="checkbox"/>	+\$0
MS	metallic silver <input type="checkbox"/>	+\$0

Step 17. Pull Finish

For arc pull (A.)

NH	brushed nickel <input type="checkbox"/>	+\$0
NK	black nickel <input type="checkbox"/>	+\$0

For bar pull (K.)

8Q	folkstone grey	+\$0
91	white	+\$0
98	studio white <input type="checkbox"/>	+\$0
G1	graphite <input type="checkbox"/>	+\$0
WL	sandstone <input type="checkbox"/>	+\$0
CN	metallic champagne <input type="checkbox"/>	+\$0
MS	metallic silver <input type="checkbox"/>	+\$0
79	green apple <input type="checkbox"/>	+\$15
MY3	yellow oxide <input type="checkbox"/>	+\$15
RO	red <input type="checkbox"/>	+\$15
TRQ	turquoise <input type="checkbox"/>	+\$15

Step 18. Counterweight

NO	no counterweight <input type="checkbox"/>	+\$0
CB	counterweight <input type="checkbox"/>	+\$115

Step 19. Lock Option

KA	keyed alike <input type="checkbox"/>	-\$10
KC	keyed differently, chrome <input type="checkbox"/>	+\$0
KD	keyed differently, black <input type="checkbox"/>	+\$0

Powered Metal Low Credenza,
Doors with Drawers

FMP74A
FMP74K

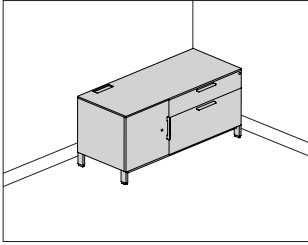

Product Information

Description

This powered credenza provides enclosed filing and storage and can be used freestanding, to support 1 end of a surface, or attached to a Canvas wall-based frame to support a frame run. It has a $\frac{3}{8}$ "-high laminate or veneer top and a painted steel case with a painted, laminate, or veneer front. The credenza is available with 4"-high architectural feet with 1" leveling glides and has a positive interlock system that permits only 1 drawer to open at a time. Drawers have full-extension ball-bearing slides. The file drawer(s) accommodate side-to-side and front-to-back filing of letter-, legal, and A4-size hanging files. Connect™ power distributors with modular ends are ordered and installed separately. Actual powered credenza widths are $47\frac{3}{4}$ ", $59\frac{3}{4}$ ", or $71\frac{3}{4}$ "; actual depth is $19\frac{7}{8}$ ".

Notes

For additional product options, see Vary Easy Program in Appendices. Arc pull option (A.) conforms to guidelines of Americans with Disabilities Act (ADA).

Grain direction is vertical on veneer and wood-grain laminate fronts. Credenza with 4"-high foot option (4) and $\frac{3}{8}$ " thin top can be used to support a Canvas wall-based frame. Order support bracket, low credenza-to-frame (FT292.) separately.

When using credenza to support 1 end of a surface, order 1 of the following products separately:

- Surface support, low credenza, adjustable height (FT299.)
- Surface support, low credenza, fixed height (FT298.)

To cover adjacent credenzas with a single top, specify credenzas with no top option (NT) and order credenza top (FM890.) separately.

Order optional metal credenza shelf (FM892.) separately.

To provide temporary guest seating on a credenza, order cushion top (FF891.) separately.

Order the following products separately:

- Connect - S310 electrical unit with connect modular connection (Y1329.)
- Connect - power entry, 4-circuit (Y1351.)
- Connect - junction block to junction block jumper, 4-circuit (Y1353.)
- Connect - H-block connector, 4-circuit (Y1354.H)

Powered credenzas must be ganged together.

For keyed-alike locks, see Keyed-Alike Information in Appendices.

Dimensions

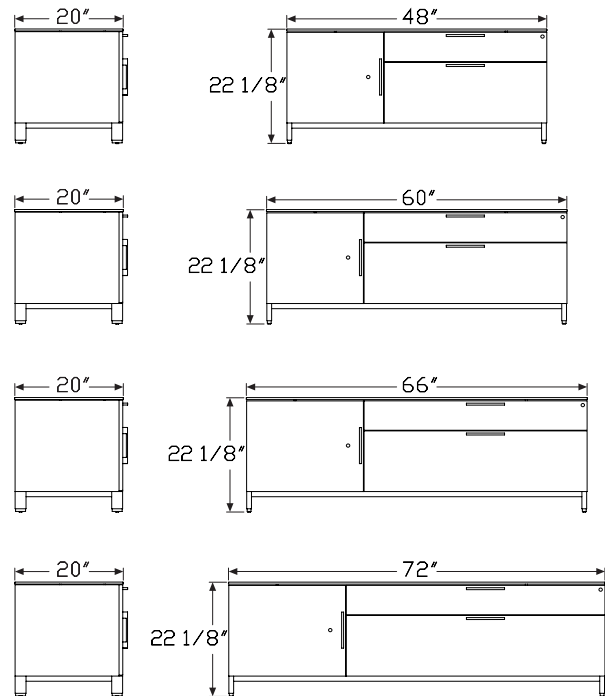

Powered Metal Low Credenza,
Doors with Drawers *continued*

Specification Information

Step 1.

FMP74

Step 2. Pull Type

- A.** arc pull
- K.** bar pull

Step 3. Width

- 48** 48" wide
- 60** 60" wide
- 72** 72" wide

Step 4. Depth

- 20** 20" deep

Step 5. Base/Foot Height

- 4** 4"-high foot

Step 6. Configuration

For 48" wide (48)

- CE** 30" box/file left, single door right
- CF** single door left, 30" box/file right

For 60" wide (60)

- CG** 30" box/file left, double doors right
- CH** double doors left, 30" box/file right
- CM** 36" box/file left, double doors right
- CN** double doors left, 36" box/file right

For 72" wide (72)

- CM** 36" box/file left, double doors right
- CN** double doors left, 36" box/file right
- CS** 42" box/file left, double doors right
- CT** double doors left, 42" box/file right

Step 7. Front Material

- P** painted metal front
- L** laminate front
- W** veneer front

Step 8. Top

For painted metal front (P) or laminate front (L)

- NT** no top
- 03** 3/8" laminate top
- 04** 3/8" veneer top

For veneer front (W)

- NT** no top
- 04** 3/8" veneer top

Step 9. Power Access Location

- L** left center access
- R** right center access

Step 10. Lock

- L** lock

Prices for Steps 1-10.

	4CEPNTLL	4CEPNTRL	4CEP03LL	4CEP03RL	4CEP04LL	4CEP04RL
FMP74A. 48 20	\$2699	2699	2812	2812	3038	3038
	4CELNTLL	4CELNTRL	4CELO3LL	4CELO3RL	4CELO4LL	4CELO4RL
FMP74A. 48 20	\$2861	2861	2974	2974	3200	3200
	4CEWNTLL	4CEWNTRL	4CEW04LL	4CEW04RL	4CGPNTLL	4CGPNTRL
FMP74A. 48 20	\$3565	3565	3904	3904	—	—
60 20	—	—	—	—	\$3137	3137
	4CGP03LL	4CGP03RL	4CGP04LL	4CGP04RL	4CGLNTLL	4CGLNTRL
FMP74A. 60 20	\$3249	3249	3476	3476	3326	3326
	4CGL03LL	4CGL03RL	4CGL04LL	4CGL04RL	4CGWNTLL	4CGWNTRL
FMP74A. 60 20	\$3439	3439	3665	3665	4307	4307
	4CGW04LL	4CGW04RL	4CFPNTLL	4CFPNTRL	4CFP03LL	4CFP03RL
FMP74A. 48 20	—	—	\$2699	2699	2812	2812
60 20	\$4646	4646	—	—	—	—
	4CFP04LL	4CFP04RL	4CFLNTLL	4CFLNTRL	4CFL03LL	4CFL03RL
FMP74A. 48 20	\$3038	3038	2861	2861	2974	2974
	4CFL04LL	4CFL04RL	4CFWNTLL	4CFWNTRL	4CFW04LL	4CFW04RL
FMP74A. 48 20	\$3200	3200	3565	3565	3904	3904
	4CHPNTLL	4CHPNTRL	4CHP03LL	4CHP03RL	4CHP04LL	4CHP04RL
FMP74A. 60 20	\$3137	3137	3249	3249	3476	3476

Powered Metal Low Credenza,
Doors with Drawers *continued*

Canvas Office Landscape® Metal Case Credenzas

	4CHLNTLL	4CHLNTRL	4CHL03LL	4CHL03RL	4CHL04LL	4CHL04RL
FMP74A. 60 20	\$3326	3326	3439	3439	3665	3665
	4CHWNTRL	4CHW04LL	4CHW04RL	4CMPNTLL	4CMPNTRL	
FMP74A. 60 20	\$4307	4307	4646	4646	3230	3230
72 20	—	—	—	—	\$3377	3377
	4CMP03LL	4CMP03RL	4CMP04LL	4CMP04RL	4CMLNTLL	4CMLNTRL
FMP74A. 60 20	\$3342	3342	3455	3455	3423	3423
72 20	\$3491	3382	3717	3717	3582	3582
	4CML03LL	4CML03RL	4CML04LL	4CML04RL	4CMWNTRL	4CMWNTRL
FMP74A. 60 20	\$3535	3535	3762	3762	4412	4437
72 20	\$3695	3695	3922	3922	4651	4651
	4CMW04LL	4CMW04RL	4CSPNTLL	4CSPNTRL	4CSP03LL	4CSP03RL
FMP74A. 60 20	\$4776	4776	—	—	—	—
72 20	\$4990	4990	3509	3509	3622	3622
	4CSP04LL	4CSP04RL	4CSLNTLL	4CSLNTRL	4CSL03LL	4CSL03RL
FMP74A. 72 20	\$3849	3849	3710	3710	3823	3823
	4CSL04LL	4CSL04RL	4CSWNTRL	4CSWNTRL	4CSW04LL	4CSW04RL
FMP74A. 72 20	\$4050	4050	4835	4835	5174	5174
	4CNPNTLL	4CNPNTRL	4CNP03LL	4CNP03RL	4CNP04LL	4CNP04RL
FMP74A. 60 20	\$3230	3230	3342	3342	3455	3455
72 20	\$3377	3377	3491	3382	3717	3717
	4CNLNTLL	4CNLNTRL	4CNL03LL	4CNL03RL	4CNL04LL	4CNL04RL
FMP74A. 60 20	\$3423	3423	3535	3535	3762	3762
72 20	\$3582	3582	3695	3695	3922	3922
	4CNWNTRL	4CNWNTRL	4CNW04LL	4CNW04RL	4CTPNTLL	4CTPNTRL
FMP74A. 60 20	\$4412	4437	4776	4776	—	—
72 20	\$4651	4651	4990	4990	3509	3509
	4CTP03LL	4CTP03RL	4CTP04LL	4CTP04RL	4CTLNTLL	4CTLNTRL
FMP74A. 72 20	\$3622	3622	3849	3849	3710	3710
	4CTL03LL	4CTL03RL	4CTL04LL	4CTL04RL	4CTWNTRL	4CTWNTRL
FMP74A. 72 20	\$3823	3823	4050	4050	4835	4835
	4CTW04LL	4CTW04RL				
FMP74A. 72 20					\$5174	5174

	4CEPNTLL	4CEPNTRL	4CEP03LL	4CEP03RL	4CEP04LL	4CEP04RL
FMP74K. 48 20	\$2699	2699	2812	2812	3038	3038
	4CELNTLL	4CELNTRL	4CELO3LL	4CELO3RL	4CELO4LL	4CELO4RL
FMP74K. 48 20	\$2861	2861	2974	2974	3200	3200
	4CEWNTLL	4CEWNTRL	4CEW04LL	4CEW04RL	4CGPNTLL	4CGPNTRL
FMP74K. 48 20	\$3565	3565	3904	3904	—	—
60 20	—	—	—	—	\$3137	3137
	4CGP03LL	4CGP03RL	4CGP04LL	4CGP04RL	4CGLNTLL	4CGLNTRL
FMP74K. 60 20	\$3249	3249	3476	3476	3326	3326
	4CGL03LL	4CGL03RL	4CGL04LL	4CGL04RL	4CGWNTRL	4CGWNTRL
FMP74K. 60 20	\$3439	3439	3665	3665	4307	4307
	4CGW04LL	4CGW04RL	4CFPNTLL	4CFPNTRL	4CFP03LL	4CFP03RL
FMP74K. 48 20	—	—	\$2699	2699	2812	2812
60 20	\$4646	4646	—	—	—	—
	4CFP04LL	4CFP04RL	4CFLNTLL	4CFLNTRL	4CFL03LL	4CFL03RL
FMP74K. 48 20	\$3038	3038	2861	2861	2974	2974
	4CFL04LL	4CFL04RL	4CFWNTRL	4CFWNTRL	4CFW04LL	4CFW04RL
FMP74K. 48 20	\$3200	3200	3565	3565	3904	3904
	4CHPNTLL	4CHPNTRL	4CHP03LL	4CHP03RL	4CHP04LL	4CHP04RL
FMP74K. 60 20	\$3137	3137	3249	3249	3476	3476
	4CHLNTLL	4CHLNTRL	4CHL03LL	4CHL03RL	4CHL04LL	4CHL04RL
FMP74K. 60 20	\$3326	3326	3439	3439	3665	3665
	4CHWNTRL	4CHWNTRL	4CHW04LL	4CHW04RL	4CMPNTLL	4CMPNTRL
FMP74K. 60 20	\$4307	4307	4646	4646	3230	3230
72 20	—	—	—	—	\$3377	3377
	4CMP03LL	4CMP03RL	4CMP04LL	4CMP04RL	4CMLNTLL	4CMLNTRL
FMP74K. 60 20	\$3342	3342	3455	3455	3423	3423
72 20	\$3382	3491	3717	3717	3582	3582
	4CML03LL	4CML03RL	4CML04LL	4CML04RL	4CMWNTRL	4CMWNTRL
FMP74K. 60 20	\$3535	3535	3762	3762	4412	4437
72 20	\$3695	3695	3922	3922	4651	4651
	4CMW04LL	4CMW04RL	4CSPNTLL	4CSPNTRL	4CSP03LL	4CSP03RL
FMP74K. 60 20	\$4776	4776	—	—	—	—
72 20	\$4990	4990	3509	3509	3622	3622

Powered Metal Low Credenza,
Doors with Drawers *continued*

	4CSP04LL	4CSP04RL	4CSLNTLL	4CSLNTRL	4CSL03LL	4CSL03RL
FMP74K. 72 20	\$3849	3849	3710	3710	3823	3823
	4CSL04LL	4CSL04RL	4CSWNTLL	4CSWNTRL	4CSW04LL	4CSW04RL
FMP74K. 72 20	\$4050	4050	4835	4835	5174	5174
	4CNPNTLL	4CNPNTRL	4CNP03LL	4CNP03RL	4CNP04LL	4CNP04RL
FMP74K. 60 20	\$3230	3230	3342	3342	3455	3455
72 20	\$3377	3377	3382	3491	3717	3717
	4CNLNTLL	4CNLNTRL	4CNL03LL	4CNL03RL	4CNL04LL	4CNL04RL
FMP74K. 60 20	\$3423	3423	3535	3535	3762	3762
72 20	\$3582	3582	3695	3695	3922	3922
	4CNWNTLL	4CNWNTRL	4CNW04LL	4CNW04RL	4CTPNTLL	4CTPNTRL
FMP74K. 60 20	\$4412	4437	4776	4776	—	—
72 20	\$4651	4651	4990	4990	3509	3509
	4CTP03LL	4CTP03RL	4CTP04LL	4CTP04RL	4CTLNTLL	4CTLNTRL
FMP74K. 72 20	\$3622	3622	3849	3849	3710	3710
	4CTL03LL	4CTL03RL	4CTL04LL	4CTL04RL	4CTWNTLL	4CTWNTRL
FMP74K. 72 20	\$3823	3823	4050	4050	4835	4835
				4CTW04LL	4CTW04RL	
FMP74K. 72 20				\$5174	5174	

Step 11. Paint/Steel Type

SS	smooth paint on smooth steel <input type="checkbox"/>	+\$0
XS	textured paint on smooth steel <input type="checkbox"/>	+\$0

Step 12. Surface Finish

Metallic Paint

For smooth paint on smooth steel (SS)

CN	metallic champagne <input type="checkbox"/>	+\$0
EH	metallic bronze <input type="checkbox"/>	+\$0
MS	metallic silver <input type="checkbox"/>	+\$0

For textured paint on smooth steel (XS)

98	studio white <input type="checkbox"/>	+\$0
8Q	folkstone grey <input type="checkbox"/>	+\$0
WL	sandstone <input type="checkbox"/>	+\$0

For textured paint on smooth steel (XS)

91	white <input type="checkbox"/>	+\$0
CL	cool grey neutral <input type="checkbox"/>	+\$0
G1	graphite <input type="checkbox"/>	+\$0
WN	warm grey neutral <input type="checkbox"/>	+\$0

Step 13. Front Finish

Solid-Color Laminate

For laminate front (L)

8Q	folkstone grey <input type="checkbox"/>	+\$0
91	white <input type="checkbox"/>	+\$0
98	studio white	+\$0
CL	cool grey neutral <input type="checkbox"/>	+\$0
LU	soft white <input type="checkbox"/>	+\$0
WL	sandstone <input type="checkbox"/>	+\$0
WN	warm grey neutral <input type="checkbox"/>	+\$0

Linen Laminate

For laminate front (L)

LBM	crisp linen	+\$0
LBN	classic linen	+\$0
LBP	casual linen	+\$0

Mesh Laminate

For laminate front (L)

LBK	pewter mesh	+\$0
LBL	steel mesh	+\$0

Twill Laminate

For laminate front (L)

LBF	neutral twill	+\$0
LBG	sarum twill	+\$0
LBH	earthen twill	+\$0
LBJ	graphite twill	+\$0
LBQ	white twill	+\$0

Powered Metal Low Credenza,
Doors with Drawers *continued*

Wood-Grain Laminate		
<i>For laminate front (L)</i>		
HM	natural maple <input type="checkbox"/>	+\$0
HP	light anigre <input type="checkbox"/>	+\$0
LBA	clear on ash	+\$0
LBR	phantom ecru	+\$0
LBS	phantom cocoa	+\$0
LBU	medium matte walnut	+\$0
LBV	warm grey teak	+\$0
LBB	oak on ash	+\$0
LBC	walnut on ash	+\$0
LBD	dark brown walnut	+\$0
LBE	medium red walnut	+\$0
76	light brown walnut <input type="checkbox"/>	+\$0
HX	aged cherry <input type="checkbox"/>	+\$0
HY	walnut on cherry <input type="checkbox"/>	+\$0

Wood Veneer		
<i>For veneer front (W)</i>		
2U	light brown walnut <input type="checkbox"/>	+\$0
40	dark brown walnut <input type="checkbox"/>	+\$0
ED	aged cherry <input type="checkbox"/>	+\$0
EK	medium red walnut <input type="checkbox"/>	+\$0
EW	medium matte walnut <input type="checkbox"/>	+\$0
ET	clear on ash <input type="checkbox"/>	+\$0
EV	walnut on ash <input type="checkbox"/>	+\$0
UL	natural maple <input type="checkbox"/>	+\$0
UX	walnut on cherry <input type="checkbox"/>	+\$0

Step 14. Top Finish

Solid-Color Laminate		
<i>For 3/8" laminate top (03)</i>		
8Q	folkstone grey <input type="checkbox"/>	+\$0
91	white <input type="checkbox"/>	+\$0
98	studio white	+\$0
CL	cool grey neutral <input type="checkbox"/>	+\$0
LU	soft white <input type="checkbox"/>	+\$0
WL	sandstone <input type="checkbox"/>	+\$0
WN	warm grey neutral <input type="checkbox"/>	+\$0

Linen Laminate		
<i>For 3/8" laminate top (03)</i>		
LBM	crisp linen	+\$0
LBN	classic linen	+\$0
LBP	casual linen	+\$0

Mesh Laminate		
<i>For 3/8" laminate top (03)</i>		
LBK	pewter mesh	+\$0
LBL	steel mesh	+\$0

Twill Laminate		
<i>For 3/8" laminate top (03)</i>		
LBF	neutral twill	+\$0
LBG	sarum twill	+\$0
LBH	earthen twill	+\$0
LBJ	graphite twill	+\$0
LBQ	white twill	+\$0

Wood-Grain Laminate		
<i>For 3/8" laminate top (03)</i>		
HM	natural maple <input type="checkbox"/>	+\$0
HP	light anigre <input type="checkbox"/>	+\$0
LBA	clear on ash	+\$0
LBR	phantom ecru	+\$0
LBS	phantom cocoa	+\$0
LBU	medium matte walnut	+\$0
LBV	warm grey teak	+\$0
LBB	oak on ash	+\$0
LBC	walnut on ash	+\$0
LBD	dark brown walnut	+\$0
LBE	medium red walnut	+\$0
76	light brown walnut <input type="checkbox"/>	+\$0
HX	aged cherry <input type="checkbox"/>	+\$0
HY	walnut on cherry <input type="checkbox"/>	+\$0

Wood Veneer		
<i>For 3/8" veneer top (04)</i>		
2U	light brown walnut <input type="checkbox"/>	+\$0
40	dark brown walnut <input type="checkbox"/>	+\$0
ED	aged cherry <input type="checkbox"/>	+\$0
EK	medium red walnut <input type="checkbox"/>	+\$0
EW	medium matte walnut <input type="checkbox"/>	+\$0
ET	clear on ash <input type="checkbox"/>	+\$0
EV	walnut on ash <input type="checkbox"/>	+\$0
UL	natural maple <input type="checkbox"/>	+\$0
UX	walnut on cherry <input type="checkbox"/>	+\$0

Step 15. Base Finish		
8Q	folkstone grey <input type="checkbox"/>	+\$0
98	studio white <input type="checkbox"/>	+\$0
WL	sandstone <input type="checkbox"/>	+\$0

Powered Metal Low Credenza, Doors with Drawers *continued*

Bright Sand Texture Paint

91	white <input type="checkbox"/>	+\$0
CL	cool grey neutral <input type="checkbox"/>	+\$0
G1	graphite <input type="checkbox"/>	+\$0
WN	warm grey neutral <input type="checkbox"/>	+\$0

Metallic Paint

CN	metallic champagne <input type="checkbox"/>	+\$0
EH	metallic bronze <input type="checkbox"/>	+\$0
MS	metallic silver <input type="checkbox"/>	+\$0

Step 16. Pull Finish

For arc pull (A.)

NH	brushed nickel <input type="checkbox"/>	+\$0
NK	black nickel <input type="checkbox"/>	+\$0

For bar pull (K.)

8Q	folkstone grey	+\$0
91	white	+\$0
98	studio white <input type="checkbox"/>	+\$0
G1	graphite <input type="checkbox"/>	+\$0
WL	sandstone <input type="checkbox"/>	+\$0
CN	metallic champagne <input type="checkbox"/>	+\$0
MS	metallic silver <input type="checkbox"/>	+\$0
79	green apple <input type="checkbox"/>	+\$15
MY3	yellow oxide <input type="checkbox"/>	+\$15
RO	red <input type="checkbox"/>	+\$15
TRQ	turquoise <input type="checkbox"/>	+\$15

Step 17. Counterweight

NO	no counterweight <input type="checkbox"/>	+\$0
CB	counterweight <input type="checkbox"/>	+\$115

Step 18. Lock Option

KA	keyed alike <input type="checkbox"/>	-\$10
KC	keyed differently, chrome <input type="checkbox"/>	+\$0
KD	keyed differently, black <input type="checkbox"/>	+\$0

Metal Credenza Shelf

FM892.

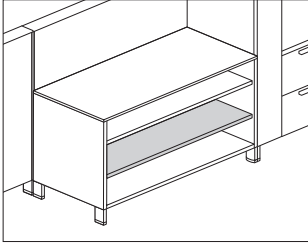

Product Information

Description

This metal shelf fits into a metal credenza to provide additional shelf storage. Shelf attachment hardware included.

Dimensions

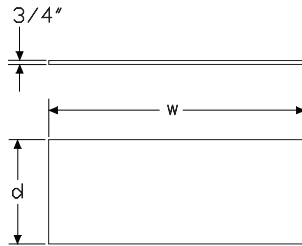

Specification Information

Step 1.

FM892. A

Step 2. Width

- 18** 18" wide A
- 24** 24" wide A
- 30** 30" wide A
- 36** 36" wide A
- 42** 42" wide A

Step 3. Depth

- 20** 20" deep A

Prices for Steps 1-3.

	20
FM892. 18	\$44
24	\$57
30	\$68
36	\$81
42	\$92

Step 4. Paint/Steel Type

- SS** smooth paint on smooth steel A +\$0
- XS** textured paint on smooth steel A +\$0

Step 5. Surface Finish

Metallic Paint

For smooth paint on smooth steel (SS)

- CN** metallic champagne A +\$0
- EH** metallic bronze A +\$0
- MS** metallic silver A +\$0

Sand Texture Paint

For textured paint on smooth steel (XS)

- 98** studio white A +\$0
- 8Q** folkstone grey A +\$0
- WL** sandstone A +\$0

Bright Sand Texture Paint

For textured paint on smooth steel (XS)

- 91** white A +\$0
- CL** cool grey neutral A +\$0
- G1** graphite A +\$0
- WN** warm grey neutral A +\$0

Credenza Top for Metal Credenza, FM889.
with Pari Screen, Storage
Attached

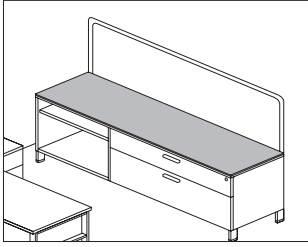

Product Information

Description

This 3/8"-high laminate or veneer credenza top covers a single credenza or 2 credenzas ganged side by side. Thin top has predrilled holes to accommodate Pari screen attachment bayonets. Thin top attachment hardware included.

Notes

Order Pari screen (FV360.) separately.

Specify thin top width to match overall width of credenza.

For configuration information, see Pari Screen planning guide.

Dimensions

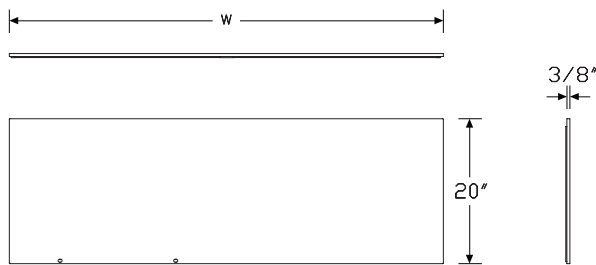

Specification Information

Step 1.

FM889.20

Step 2. Width

- 30** 30" wide
- 36** 36" wide
- 42** 42" wide
- 48** 48" wide
- 60** 60" wide
- 66** 66" wide
- 72** 72" wide

Step 3. Top Material

- 03** 3/8" laminate top
- 04** 3/8" veneer top

Step 4. Configuration

For 30" wide (30), 36" wide (36), or 42" wide (42)

- FW** full width screen

For 48" wide (48)

- AA** 30" screen left
- AB** 30" screen right
- FW** full width screen

For 60" wide (60)

- AA** 30" screen left
- AB** 30" screen right
- AC** 36" screen left
- AD** 36" screen right
- FW** full width screen

For 66" wide (66) or 72" wide (72)

- AC** 36" screen left
- AD** 36" screen right
- AE** 42" screen left
- AF** 42" screen right
- FW** full width screen

Prices for Steps 1-4.

		AA	AB	AC	AE	AD	AF
FM889.20	48 03	\$387	387	—	—	—	—
	04	\$848	848	—	—	—	—
	60 03	\$476	476	476	—	476	—
	04	\$967	967	967	—	967	—

Credenza Top for Metal Credenza,
with Pari Screen, Storage
Attached *continued*

66 03	—	—	\$517	517	517	517
04	—	—	\$1051	1051	1051	1051
72 03	—	—	\$538	538	538	538
04	—	—	\$1082	1082	1082	1082
					FW	
FM889.20 30 03						\$283
04						\$671
36 03						\$320
04						\$749
42 03						\$367
04						\$796
48 03						\$387
04						\$848
60 03						\$476
04						\$967
66 03						\$517
04						\$1051
72 03						\$538
04						\$1082

Step 5. Top Finish

For 3/8" laminate top (03)

LBM	crisp linen <input type="checkbox"/>	+\$0
LBN	classic linen <input type="checkbox"/>	+\$0
LBP	casual linen <input type="checkbox"/>	+\$0

For 3/8" laminate top (03)

LBK	pewter mesh <input type="checkbox"/>	+\$0
LBL	steel mesh <input type="checkbox"/>	+\$0

For 3/8" laminate top (03)

8Q	folkstone grey <input type="checkbox"/>	+\$0
91	white <input type="checkbox"/>	+\$0
CL	cool grey neutral <input type="checkbox"/>	+\$0
LU	soft white <input type="checkbox"/>	+\$0
WL	sandstone <input type="checkbox"/>	+\$0
WN	warm grey neutral <input type="checkbox"/>	+\$0

For 3/8" laminate top (03)

LBF	neutral twill <input type="checkbox"/>	+\$0
LBG	sarum twill <input type="checkbox"/>	+\$0
LBH	earthen twill <input type="checkbox"/>	+\$0
LBJ	graphite twill <input type="checkbox"/>	+\$0
LBQ	white twill <input type="checkbox"/>	+\$0

For 3/8" laminate top (03)

76	light brown walnut <input type="checkbox"/>	+\$0
HM	natural maple <input type="checkbox"/>	+\$0
HP	light anigre <input type="checkbox"/>	+\$0
HX	aged cherry <input type="checkbox"/>	+\$0
HY	walnut on cherry <input type="checkbox"/>	+\$0
LBA	clear on ash <input type="checkbox"/>	+\$0
LBR	phantom ecru <input type="checkbox"/>	+\$0
LBS	phantom cocoa <input type="checkbox"/>	+\$0
LBU	medium matte walnut <input type="checkbox"/>	+\$0
LBV	warm grey teak <input type="checkbox"/>	+\$0
LBB	oak on ash <input type="checkbox"/>	+\$0
LBC	walnut on ash <input type="checkbox"/>	+\$0
LBD	dark brown walnut <input type="checkbox"/>	+\$0
LBE	medium red walnut <input type="checkbox"/>	+\$0

For 3/8" veneer top (04)

2U	light brown walnut <input type="checkbox"/>	+\$0
40	dark brown walnut <input type="checkbox"/>	+\$0
ED	aged cherry <input type="checkbox"/>	+\$0
EK	medium red walnut <input type="checkbox"/>	+\$0
EW	medium matte walnut <input type="checkbox"/>	+\$0
ET	clear on ash <input type="checkbox"/>	+\$0
EU	oak on ash <input type="checkbox"/>	+\$0
EV	walnut on ash <input type="checkbox"/>	+\$0
UL	natural maple <input type="checkbox"/>	+\$0
UX	walnut on cherry <input type="checkbox"/>	+\$0

Pari Screen, Storage Attached

FV360.

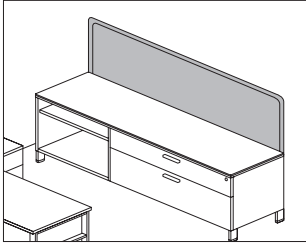

Product Information

Description

This tackable fabric screen attaches to a Canvas low credenza using the thin top and provides boundary with a tackable surface. Attachment hardware included.

Notes

Order credenza thin top separately:

- Credenza top for wood credenza (FF889.)
- Credenza top for metal credenza (FM889.)

Pre-drilled holes near back edge of credenza thin top allow for bayonets to extend up to support the screen.

Works with standard and powered Canvas credenzas.

Screen accepts Customer's Own Material (COM). Yardage is estimated for nondirectional 54"-wide fabrics.

For vertical fabric direction (T):

Height—Yardage

- 24—0.95
- 30—1.14
- 36—1.32

For horizontal fabric direction (R), for 42" high:

Width—Yardage

- 24—0.95
- 30—1.14
- 36—1.32
- 42—1.51
- 48—1.71
- 60—2.07
- 66—2.27
- 72—2.46

For horizontal fabric direction (R), for 46" high and 53" high:

Width—Yardage

- 24—1.90
- 30—2.27
- 36—2.66
- 42—3.02
- 48—3.41
- 60—4.17
- 66—4.54
- 72—4.92

For information on multiple quantities or directional fabrics, contact COM Department. See Order Information in Appendices.

Dimensions

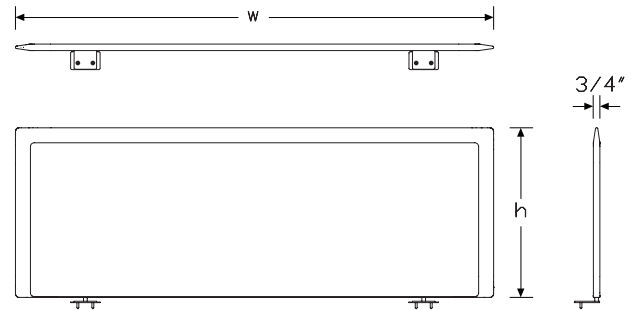

Pari Screen, Storage Attached

continued

Canvas Office Landscape® Metal Case Credenzas

Specification Information

Step 1.

FV360. A

Step 2. Attachment

CS Canvas credenza attached, single A

CB Canvas credenza attached, back to back A

Step 3. Height

42 42" high A

46 46" high A

53 53" high A

Step 4. Width

30 30" wide A

36 36" wide A

42 42" wide A

48 48" wide A

60 60" wide A

66 66" wide A

72 72" wide A

Step 5. Surface Material

For 30" wide (30), 36" wide (36), 42" wide (42), or 48" wide (48)

R tackable fabric, horizontal A

T tackable fabric A

For 60" wide (60), 66" wide (66), or 72" wide (72)

R tackable fabric, horizontal A

Prices for Steps 1-5.

	30R	30T	36R	36T	42R	42T
FV360. CS 42	\$735	735	765	765	810	810
46	\$765	765	855	855	900	900
53	\$900	900	945	945	1095	1095
CB 42	\$735	735	765	765	810	810
46	\$765	765	855	855	900	900
53	\$900	900	945	945	1095	1095
	48R	48T	60R	66R	72R	
FV360. CS 42	\$945	945	1080	1100	1125	
46	\$990	990	1125	1190	1215	
53	\$1170	1170	1305	1370	1395	
CB 42	\$945	945	1080	1100	1125	
46	\$990	990	1125	1190	1215	
53	\$1170	1170	1305	1370	1395	

Step 6. Fabric

For 30" wide (30), 36" wide (36), or 42" wide (42)

Price Category 1 +\$0

Price Category 2 +\$38

Price Category 3 +\$90

Price Category 4 +\$156

Price Category E +\$325

For 48" wide (48) or 60" wide (60)

Price Category 1 +\$0

Price Category 2 +\$31

Price Category 3 +\$74

Price Category 4 +\$127

Price Category E +\$325

For 66" wide (66) or 72" wide (72)

Price Category E +\$325

Price Category 1 +\$0

Price Category 2 +\$38

Price Category 3 +\$90

Price Category 4 +\$156

Credenza Top for Metal Credenza FM890.

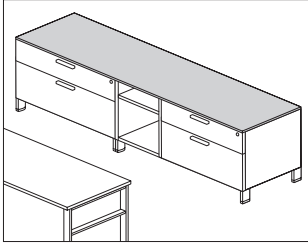

Product Information

Description

This 3/8"-high credenza top can be used to cover a single credenza or 2 credenzas that are ganged side-by-side. Attachment hardware included.

Notes

For additional product options, see Vary Easy Program in Appendices.

Dimensions

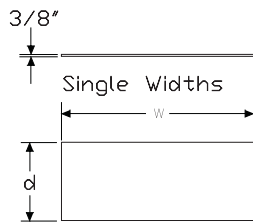

Combination Widths
60" Wide



30"/30"

66" Wide



36"/30"

72" Wide



36"/36", 42"/30"

Specification Information

Step 1.

FM890.20

Step 2. Width

- 30** 30" wide
- 36** 36" wide
- 42** 42" wide
- 48** 48" wide
- 60** 60" wide
- 66** 66" wide
- 72** 72" wide

Step 3. Top Material

- 03** 3/8" laminate top
- 04** 3/8" veneer top

Prices for Steps 1-3.

		03	04
FM890.20	30	\$280	667
	36	\$318	750
	42	\$362	796
	48	\$386	850
	60	\$472	973
	66	\$518	1056
	72	\$540	1094

Step 4. Top Finish

Solid-Color Laminate

For 3/8" laminate top (03)

8Q	folkstone grey <input type="checkbox"/>	+\$0
91	white <input type="checkbox"/>	+\$0
98	studio white	+\$0
CL	cool grey neutral <input type="checkbox"/>	+\$0
LU	soft white <input type="checkbox"/>	+\$0
WL	sandstone <input type="checkbox"/>	+\$0
WN	warm grey neutral <input type="checkbox"/>	+\$0

Linen Laminate

For 3/8" laminate top (03)

LBM	crisp linen	+\$0
LBN	classic linen	+\$0
LBP	casual linen	+\$0

Credenza Top for Metal Credenza

continued

Canvas Office Landscape® Metal Case Credenzas

Mesh Laminate

For 3/8" laminate top (03)

LBK	pewter mesh	+\$0
LBL	steel mesh	+\$0

Twill Laminate

For 3/8" laminate top (03)

LBF	neutral twill	+\$0
LBG	sarum twill	+\$0
LBH	earthen twill	+\$0
LBJ	graphite twill	+\$0
LBQ	white twill	+\$0

Wood-Grain Laminate

For 3/8" laminate top (03)

HM	natural maple <input type="checkbox"/> A	+\$0
HP	light anigre <input type="checkbox"/> A	+\$0
LBA	clear on ash	+\$0
LBR	phantom ecru	+\$0
LBS	phantom cocoa	+\$0
LBU	medium matte walnut	+\$0
LBV	warm grey teak	+\$0
LBB	oak on ash	+\$0
LBC	walnut on ash	+\$0
LBD	dark brown walnut	+\$0
LBE	medium red walnut	+\$0
76	light brown walnut <input type="checkbox"/> A	+\$0
HX	aged cherry <input type="checkbox"/> A	+\$0
HY	walnut on cherry <input type="checkbox"/> A	+\$0

Wood Veneer

For 3/8" veneer top (04)

2U	light brown walnut <input type="checkbox"/> A	+\$0
40	dark brown walnut <input type="checkbox"/> A	+\$0
ED	aged cherry <input type="checkbox"/> A	+\$0
EK	medium red walnut <input type="checkbox"/> A	+\$0
EW	medium matte walnut <input type="checkbox"/> A	+\$0
ET	clear on ash <input type="checkbox"/> A	+\$0
EU	oak on ash <input type="checkbox"/> A	+\$0
EV	walnut on ash <input type="checkbox"/> A	+\$0
UL	natural maple <input type="checkbox"/> A	+\$0
UX	walnut on cherry <input type="checkbox"/> A	+\$0

Credenza Cushion Top

FF891.

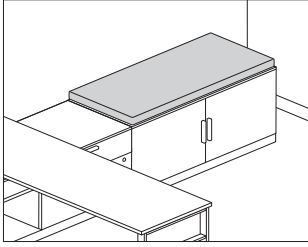

Product Information

Description

This cushion attaches to the top of a metal or wood credenza to provide temporary guest seating. Attachment hardware included.

Notes

Cushion accepts Customer's Own Material (COM). Yardage is estimated for nondirectional, 54"-wide fabrics. Order 1 yard of fabric per cushion. For odd number of cushions, round up to next full yard. For information on multiple quantities or directional fabrics, contact COM Department. See Order Information in Appendices.

Dimensions

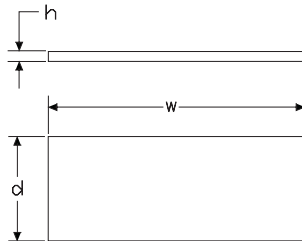

Specification Information

Step 1.

FF891. A

Step 2. Height

01 1" high A

02 2" high A

Step 3. Depth

20 20" deep A

Step 4. Width

24 24" wide A

30 30" wide A

36 36" wide A

42 42" wide A

48 48" wide A

Prices for Steps 1-4.

	24	30	36	42	48
FF891. 01 20	\$244	262	281	292	306
02 20	\$293	318	345	366	385

Step 5. Fabric

See application chart and textiles list for fabric usage and numbers.

First 2 digits of number indicate fabric line; remaining digit(s) indicate fabric color.

Price Category 1	+\$0
Price Category 2	+\$102
Price Category 3	+\$123
Price Category 4	+\$151
Price Category 5	+\$169
Price Category 7	+\$206
Price Category 8	+\$146
Price Category 9	+\$1425
Price Category (Geiger) 10	+\$1050
Price Category B	+\$71
Price Category C	+\$98
Price Category D	+\$82
Price Category E	+\$150
Price Category F	+\$193
Price Category G	+\$251
Price Category H	+\$305
Price Category I	+\$359
Price Category J	+\$413
Price Category K	+\$310

Support Bracket, Low Credenza-to-Frame

FT292.

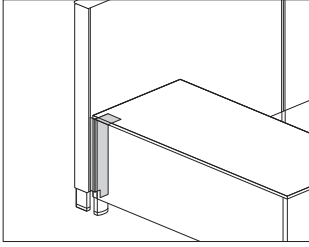

Product Information

Description

This bracket attaches between a Canvas wood or metal credenza and a frame. It allows the credenza to attach parallel or perpendicular to the frame, providing support to a frame run in place of a return wall or work surface support.

Notes

Bracket attaches credenza with no gap or with a 1" gap from the front of the frame to allow room for cords and cables.

Support bracket attaches to low credenza with 4" foot only.

Support bracket also attaches to back of a 60" wide or wider low credenza where 2 units are joined.

Support bracket orientation (left or right) is determined by the frame orientation as you are facing the frame. Credenza can be attached parallel or perpendicular to a frame. Bracket attaches to the back left or back right of the low credenza.

Dimensions

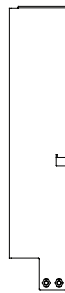
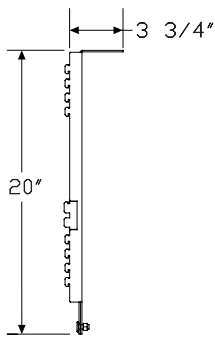
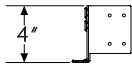

Specification Information

Step 1.

FT292.

Step 2. Storage Type

M for use with metal low credenza with 4" high foot

C for use with wood low credenza with 4" high foot **A**

Step 3. Frame Attachment Location

L left end of frame

R right end of frame

Step 4. Storage Attachment Position

N no gap, for storage tight to wall

G 1" gap, for cord drop

Prices for Steps 1-4.

		N	G
FT292.	M L	\$129	129
	R	\$129	129
	C L	\$129	129
	R	\$129	129

Step 5. Surface Finish

Bright Sand Texture Paint

91	white	+\$0
CL	cool grey neutral	+\$0
G1	graphite	+\$0
WN	warm grey neutral	+\$0
8Q	folkstone grey	+\$0
98	studio white	+\$0
WL	sandstone	+\$0

Metallic Paint

CN	metallic champagne	+\$0
EH	metallic bronze	+\$0
MS	metallic silver	+\$0

Powered Storage Ganging Bracket Kit PS900

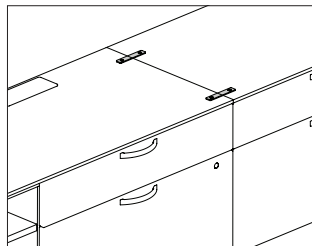

Product Information

Description

This kit has 2 brackets that attach to the case under the tops of 2 adjacent surfaces, ganging them together to provide stability and allowing electrical components to be routed from one case to another. Finish is black.

Notes

Power that is being routed from one case to another requires the cases be ganged together.
Single cases require counterweight to be specified.

Specification Information

Step 1.

PS900 A

\$31

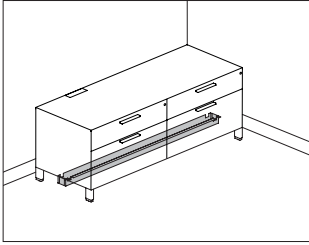

Product Information

Description

This cable cover attaches to a metal or wood Canvas Office Landscape® powered low credenza, and is available in 3 configurations: center, full-span, and side placement. It is used in conjunction with Connect™ components to comply with UL1286 listing. Finish is black.

Notes

Order the following products separately:

- Canvas powered metal low credenza (FMP72, FMP73, FMP74)
- Canvas powered wood low credenza (FFD72, FFD73, FFD74)
- Connect - S310 electrical unit with connect modular connection (Y1329.)
- Connect - power entry, 4-circuit (Y1351.)
- Connect - junction block to junction block jumper, 4-circuit (Y1353.)
- Connect - H-block connector, 4-circuit (Y1354.H)
- Powered storage distributor cover (FPS911.)

Canvas Office Landscape® Metal Case Credenzas

Dimensions

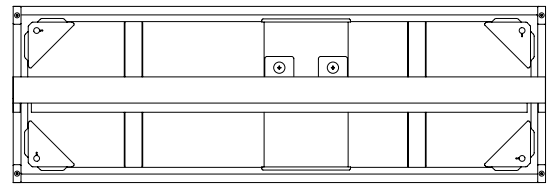

Full

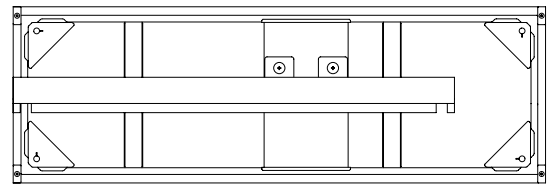

Side

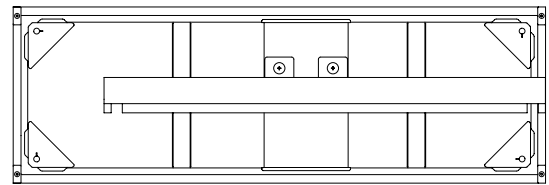

Side

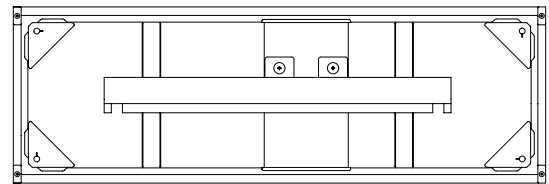

Center

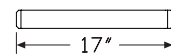
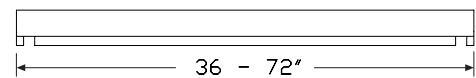

Cross bars for use with metal credenza only

Powered Storage Cable Cover

continued

Specification Information

Step 1.

FPS910. A

Step 2. Material

F for use with wood powered low credenza A

M for use with metal powered low credenza A

Step 3. Case Width

48 48" wide A

60 60" wide A

66 66" wide A

72 72" wide A

Step 4. Configuration

C center A

F full A

S side A

Prices for Steps 1-4.

			C	F	S
FPS910. F	48		\$97	97	97
	60		\$120	120	120
	66		\$120	120	120
	72		\$120	120	120
M	48		\$204	204	204
	60		\$227	227	227
	66		\$227	227	227
	72		\$227	227	227

Powered Storage Distributor Cover

FPS911

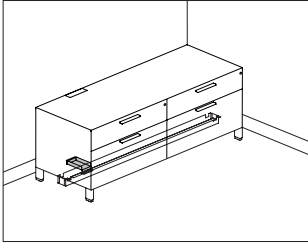

Product Information

Description

This distributor cover attaches to a metal or wood Canvas Office Landscape® powered low credenza. It is used in conjunction with a powered storage cable cover and Connect™ components to comply with UL1286 listing. Finish is black.

Notes

Order the following products separately:

- Canvas powered metal low credenza (FMP72, FMP73, FMP74)
- Canvas powered wood low credenza (FFD72, FFD73, FFD74)
- Connect - S310 electrical unit with connect modular connection (Y1329.)
- Connect - power entry, 4-circuit (Y1351.)
- Connect - junction block to junction block jumper, 4-circuit (Y1353.)
- Connect - H-block connector, 4-circuit (Y1354.H)
- Powered storage cable cover (FPS910.)

Dimensions

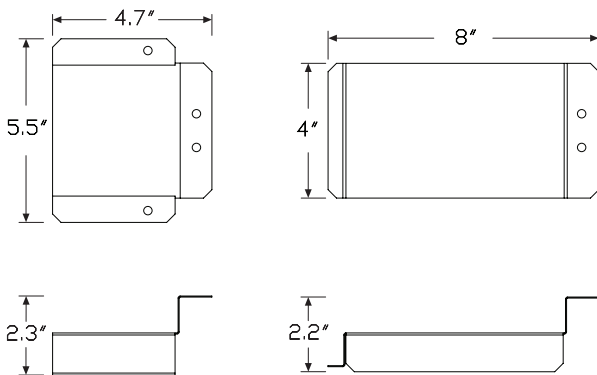

Specification Information

Step 1.

FPS911. A

Step 2. Material

F for use with wood powered low credenza A

M for use with metal powered low credenza A

Prices for Steps 1-2.

FPS911. F	\$52
M	\$52

Connect™ - S310 Electrical Unit with Connect Modular Connection Y1329.

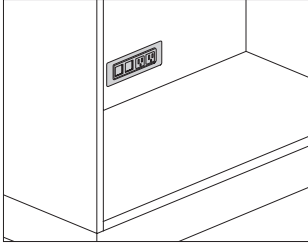

Product Information

Description

This electrical distributor provides power to a lateral file, low credenza, or storage case with a Connect™ 4-circuit modular connector. It can be top surface mounted flush or vertically mounted in the false back of a cabinet. A voice/data adapter kit is included, allowing the data openings to accept various manufacturers' couplers and jacks. Attachment hardware is included. Product is UL listed.

Notes

Field cutting of surface may be required. Information on surface cutout size is included on instruction sheet.

Silver option (OI) and white option (OJ) have painted metal trim with white plastic simplex/data interiors. Black option (OH) has black painted trim with black plastic simplex/data interior.

Modular electrical connectors can only connect to Connect 4-circuit modular power system.

Order the following products separately:

- Canvas powered metal low credenza (FMP72A., FMP72K., FMP73A., FMP73K., FMP74A., FMP74K.)
- Canvas powered wood low credenza (FFD72A., FFD72K., FFD73A., FFD73K., FFD74A., FFD74K.)
- Meridian powered storage case (PSC-, PS6-, PSAM-, PSAV-, PSKM-, PSKV-)
- Meridian powered storage lateral file (PS26-, PS2AM, PS2AV, PS2KM, PS2KV)
- Connect - power entry, 4-circuit (Y1351.)
- Connect - junction block to junction block jumper, 4-circuit (Y1353.)
- Connect - block connector, 4-circuit (Y1354.)
- Other Connect 4-circuit modular power components as required

For Canvas powered storage, order Connect - conduit clamp (Y1339.) separately.

Dimensions

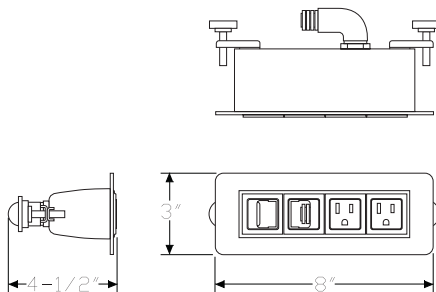

Specification Information

Step 1.

Y1329.

Step 2. Configuration

3	2 simplex receptacles, 2 data openings
8	3 simplex receptacles, 1 data opening

Step 3. Power Type

E	4 circuit circuit 1
F	4 circuit circuit 2
G	4 circuit circuit 3
H	4 circuit circuit 4

Step 4. Cord/Conduit Length

02	2' conduit
03	3' conduit
04	4' conduit
06	6' conduit
10	10' conduit

Prices for Steps 1-4.

		02	03	04	06	10
Y1329. 3	E	\$331	340	349	371	411
	F	\$331	340	349	371	411
	G	\$331	340	349	371	411
	H	\$331	340	349	371	411
8	E	\$346	355	368	386	426
	F	\$346	355	368	386	426
	G	\$346	355	368	386	426
	H	\$346	355	368	386	426

Step 5. Finish

OH	black	+\$0
OI	silver	+\$0
OJ	white	+\$0

Connect™-Power Entry, 4-Circuit Y1351.

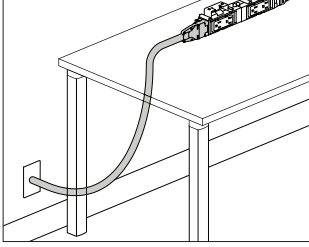

Product Information

Description
 This power entry connects a building's electrical from a wall, floor, or column to the end of a 4-circuit dual junction block power kit or junction block and distributes up to 4 20-amp circuits. UL 183 listed, CUL Certified.

Notes

Connect™ modular power products are not compatible with electrical components used in Herman Miller systems or desking product lines. Power entry can be field cut to the appropriate length. For San Francisco, specify 3/8" flex metallic conduit option (C). Finish color on liquid tight conduit is black. Finish color on metallic conduit is silver. A licensed electrician must wire the power entry to the building's electrical system.

Dimensions

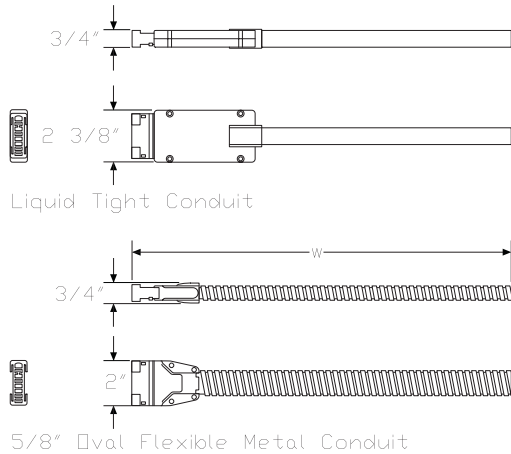

Specification Information

Step 1.

Y1351.

Step 2. Length

06	6' long
12	12' long
18	18' long
24	24' long

Step 3. Conduit Type

L	liquid tight conduit
C	3/8" flex metallic conduit

Prices for Steps 1-3.

	L	C
Y1351. 06	\$152	152
12	\$217	217
18	\$285	285
24	\$365	365

Canvas Office Landscape® Metal Case Credenzas

Connect™-Junction Block to Junction Block Jumper, 4-Circuit

Y1353.

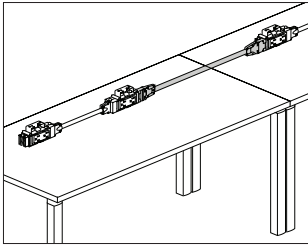

Product Information

Description

This power jumper distributes up to 4 20-amp circuits between 2 power kits or junction blocks and is available as adjustable or non-adjustable. The adjustable jumper allows 1 end of the jumper to extend an additional 3" when connecting to components under an adjacent desk or table. UL 183 listed, CUL Certified.

Notes

- Connect™ modular power products are not compatible with electrical components used in Herman Miller systems or desking product lines. When routing power to an adjacent desk or table, surfaces must be ganged together. Order ganging bracket kit (Y1338.) separately.
- When connecting dual junction block power kits (Y1350.) between adjacent surfaces in a linear run, specify 24"-wide jumper.
- When connecting dual junction block power kits (Y1350.) at the outside corner of 2 24"-deep surfaces at 90°, specify 42"-wide jumper.
- When connecting dual junction block power kits (Y1350.) at the outside corner of 2 30"-deep surfaces at 90°, specify 48"-wide jumper.
- When connecting dual junction block power kits (Y1350.) at the outside corner of 1 30"-deep and 1 24"-deep surface, specify 48"-wide jumper.
- When connecting dual junction block power kits (Y1350.) at the inside corner of 2 24"- or 30"-deep surfaces, specify 30"-wide jumper.
- Finish on 5/8" oval metallic conduit is silver.
- Order the following products separately:
- Conduit clamps (Y1339.)
 - Dual junction block power kit, 4-circuit (Y1350.) or junction block, 4-circuit (Y1358.)
 - Duplex receptacle, 4-circuit (Y1355.) - for junction block, 4-circuit
 - Junction block bracket, 4-circuit (Y1357.) - for junction block, 4-circuit
 - Power entry, 4-circuit (Y1351.)

Dimensions

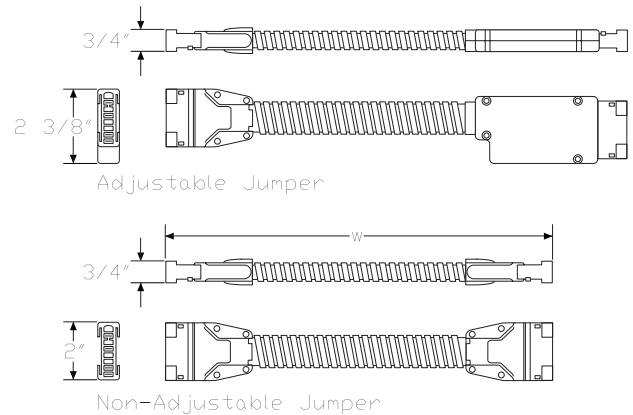

Connect™-Junction Block to Junction Block Jumper, 4-Circuit

continued

Specification Information

Step 1.

Y1353.

Step 2. Width

12	12" wide
18	18" wide
24	24" wide
30	30" wide
36	36" wide
42	42" wide
48	48" wide
54	54" wide
60	60" wide
66	66" wide
72	72" wide
78	78" wide
84	84" wide
90	90" wide
108	108" wide
120	120" wide
132	132" wide
144	144" wide

Step 3. Type

A	adjustable jumper
N	nonadjustable jumper

Prices for Steps 1-3.

	A	N
Y1353. 12	\$77	77
18	\$82	82
24	\$88	88
30	\$94	94
36	\$99	99
42	\$104	104
48	\$111	111
54	\$116	116
60	\$122	122
66	\$127	127
72	\$132	132
78	\$138	138
84	\$143	143
90	\$150	150
108	\$166	166
120	\$176	176
132	\$188	188
144	\$200	200

Connect™-Block Connector, 4-Circuit

Y1354.

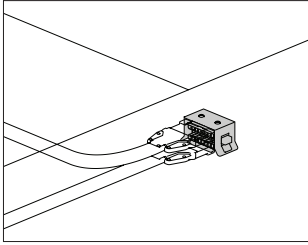

Product Information

Description

This block connects components together to distribute power. The H-block connector connects jumpers together at 2-, 3-, and 4-way connection points, or distributes power from a power entry to multiple components. The receptacle-to-receptacle connectors connect 2 junction blocks together. Finish is black. Attachment hardware included. UL 183 listed, CUL Certified.

Notes

Connect™ modular power products are not compatible with electrical components used in Herman Miller systems or desking product lines. When routing power to an adjacent desk or table, surfaces must be ganged together. Order ganging bracket kit (Y1338.) separately.

Dimensions

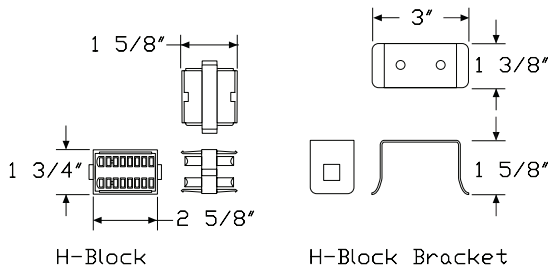

H-Block

H-Block Bracket

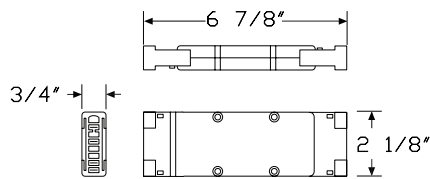

Receptacle-to-Receptacle Block Connector

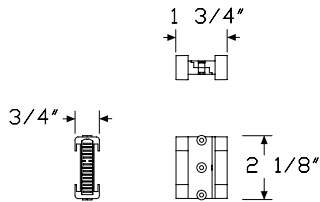

Short Receptacle-to-Receptacle Block Connector

Specification Information

Step 1.

Y1354.

Step 2. Connector Type

- H** H-block connector
- S** short receptacle-to-receptacle block connector A
- R** receptacle-to-receptacle block connector

Prices for Steps 1-2.

Y1354. H	\$42
S	\$52
R	\$54

Front-to-Back Filing Rail

FM920.

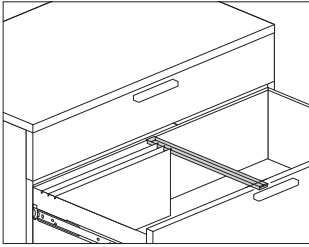

Product Information

Description

This filing rail holds letter-size files for front-to-back filing. The 18"-deep rail is used in a metal low credenza. The 20"-deep rail is used in a metal lateral file. Finish is black umber.

Dimensions

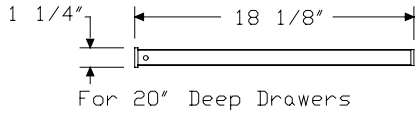
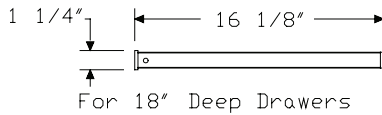

Specification Information

Step 1.

FM920.

Step 2. Width

- 00** for 30"- or 42"-wide drawers
- 36** for 36"-wide drawers

Step 3. Depth

- 18** for 18"-deep low credenza file drawer
- 20** for 20"-deep 2-high lateral file drawer

Prices for Steps 1-3.

	18	20
FM920.00	\$33	33
36	\$33	33

Side-to-Side Filing Rail

FM921.

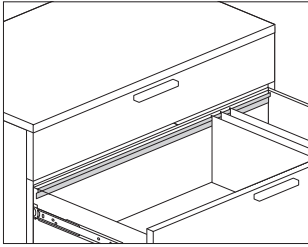

Product Information

Description

This filing rail holds letter- or legal-sized hanging folder for side-to-side filing in a metal low credenza or lateral file. Finish is black umber.

Dimensions

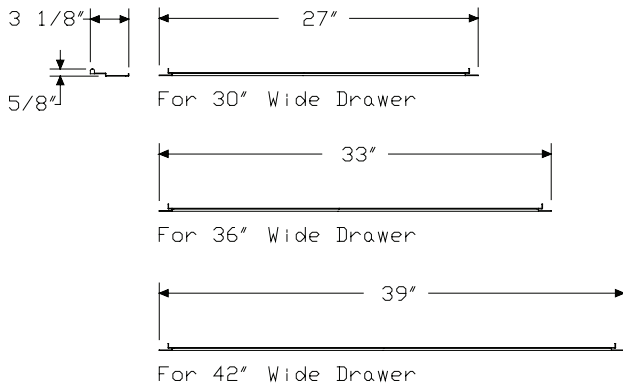

Specification Information

Step 1.

FM921.

Step 2. Quantity

- 1 1 filing rail
- 2 2 filing rails

Step 3. Width

- 30 for 30"-wide drawers
- 36 for 36"-wide drawers
- 42 for 42"-wide drawers

Prices for Steps 1-3.

	30	36	42
FM921. 1	\$24	24	24
2	\$47	47	47

Movable Divider

FM922.
FM929.

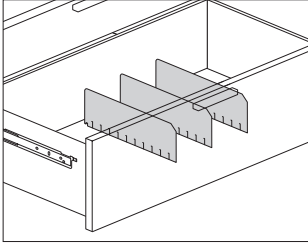

Product Information

Description

This adjustable metal divider fits into slots of a metal low credenza or lateral file drawer. The 18"-deep divider is used in a metal low credenza. The 20"-deep divider is used in a metal lateral file. Finish is black umber.

Dimensions

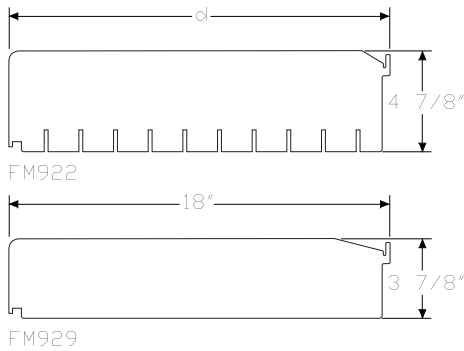

Specification Information

Step 1.

FM92

Step 2. Type

- 2. file drawer divider
- 9. credenza box drawer divider

Step 3. Quantity

- 1 1 divider
- 3 3 dividers

Step 4. Depth

For file drawer divider (2.)

- 18 for 18"-deep low credenza
- 20 for 20"-deep 2-high lateral file

For credenza box drawer divider (9.)

- 18 for 18"-deep low credenza

Prices for Steps 1-4.

	18	20
FM922. 1	\$34	34
3	\$85	85
FM929. 1	\$34	—
3	\$85	—

File Drawer Organizer

FM923.

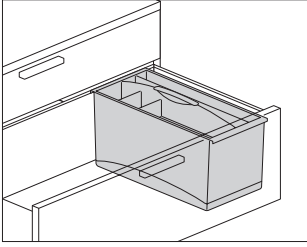

Product Information

Description

This 2-piece plastic organizer fits into any file drawer configured for letter-size filing. It has a removable top tray with sections for storing small items, and a bottom bin that can hold larger items or be divided into 3 sections; 2 vertical dividers included. Finish is black umber.

Dimensions

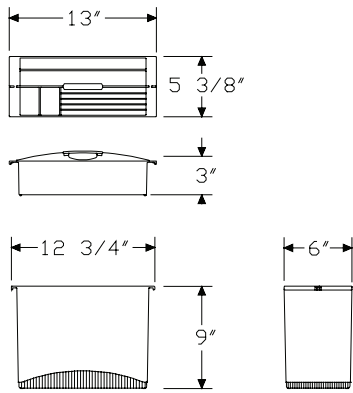

Specification Information

Step 1.

FM923.

\$85

Open Shelf Organizer

FF900.

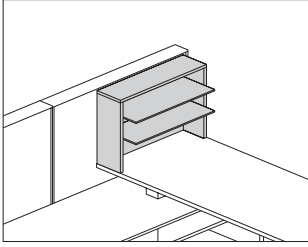

Product Information

Description
 This organizer sits on a surface or credenza to provide open storage and organization of small items. It has a laminate or veneer case with aluminum shelves.

Notes

For additional product options, see Vary Easy Program in Appendices.
 24", 30", and 36" widths match the depth of peninsula surfaces; 23" and 29" widths match the depth of standard surfaces.
 Order open shelf organizer divider (FF901.) separately.

Dimensions

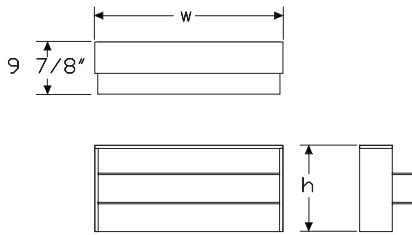

Specification Information

Step 1.

FF900. A

Step 2. Height

- 13** 12 1/2" high A
- 17** 16 1/2" high A
- 24** 23 1/2" high A

Step 3. Width

- 23** 23" wide A
- 24** 24" wide A
- 29** 29" wide A
- 30** 30" wide A
- 36** 36" wide A

Step 4. Case Material

- L** laminate A
- W** veneer A

Prices for Steps 1-4.

			L	W
FF900.	13	23	\$774	1160
		24	\$774	1160
	17	23	\$862	1226
		24	\$862	1226
		29	\$862	1226
24	23	30	\$834	1293
		36	\$862	1343
	29	23	\$862	1343
		24	\$892	1406
		29	\$892	1406
30	23	30	\$921	1471
		36	\$951	1520
	24	23	\$951	1520
		24	\$980	1587
		29	\$980	1587
36	23	\$1008	1653	
	24			
	29			

Step 5. Top/Case/Edge Finish

Solid-Color Laminate

For laminate (L)

8Q	folkstone grey <input type="checkbox"/>	+\$0
91	white <input type="checkbox"/>	+\$0
98	studio white	+\$0
CL	cool grey neutral <input type="checkbox"/>	+\$0
LU	soft white <input type="checkbox"/>	+\$0
WL	sandstone <input type="checkbox"/>	+\$0
WN	warm grey neutral <input type="checkbox"/>	+\$0

Linens Laminate

For laminate (L)

LBM	crisp linen	+\$0
LBN	classic linen	+\$0
LBP	casual linen	+\$0

Mesh Laminate

For laminate (L)

LBK	pewter mesh	+\$0
LBL	steel mesh	+\$0

Twill Laminate

For laminate (L)

LBF	neutral twill	+\$0
LBG	sarum twill	+\$0
LBH	earthen twill	+\$0
LBJ	graphite twill	+\$0
LBQ	white twill	+\$0

Wood-Grain Laminate

For laminate (L)

HM	natural maple <input type="checkbox"/>	+\$0
HP	light anigre <input type="checkbox"/>	+\$0
LBA	clear on ash	+\$0
LBR	phantom ecru	+\$0
LBS	phantom cocoa	+\$0
LBU	medium matte walnut	+\$0
LBV	warm grey teak	+\$0
LBB	oak on ash	+\$0
LBC	walnut on ash	+\$0
LBD	dark brown walnut	+\$0
LBE	medium red walnut	+\$0
76	light brown walnut <input type="checkbox"/>	+\$0
HX	aged cherry <input type="checkbox"/>	+\$0
HY	walnut on cherry <input type="checkbox"/>	+\$0

Wood Veneer

For veneer (W)

2U	light brown walnut <input type="checkbox"/>	+\$0
40	dark brown walnut <input type="checkbox"/>	+\$0
ED	aged cherry <input type="checkbox"/>	+\$0
EK	medium red walnut <input type="checkbox"/>	+\$0
EW	medium matte walnut <input type="checkbox"/>	+\$0
ET	clear on ash <input type="checkbox"/>	+\$0
EU	oak on ash <input type="checkbox"/>	+\$0
EV	walnut on ash <input type="checkbox"/>	+\$0
UL	natural maple <input type="checkbox"/>	+\$0
UX	walnut on cherry <input type="checkbox"/>	+\$0

Step 6. Shelf Finish

Anodized Aluminum

AN	clear anodized aluminum <input type="checkbox"/>	+\$0
-----------	--	------

Open Shelf Organizer, Divider

FF901.

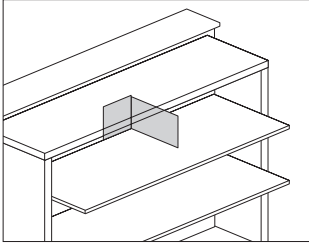

Product Information

Description

This divider fits on an open shelf organizer to divide shelf space.
Package contains 2.

Notes

Order open shelf organizer (FF900.) separately.

Dimensions

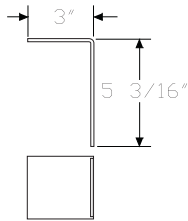

Specification Information

Step 1.

FF901. A \$119

Step 2. Surface Finish

AN clear anodized aluminum A +\$0

Wood Case Lateral Files

Wood Case Pedestals

Wood Case Cabinets and Bookcases

Wood Case Cabinets and Bookcases (Legacy Products)

Wood Case Credenzas

Wood Case Storage Organizers



Wood Freestanding Lateral File

FF20A.
FF20K.

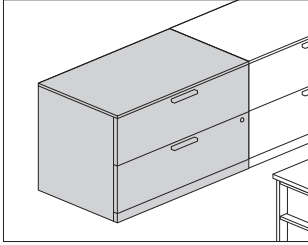

Product Information

Description

This lateral file has a $\frac{3}{8}$ "-high laminate or veneer top, and the choice of a laminate case and front, veneer case and front, or laminate case with veneer front. It has a $2\frac{1}{4}$ "-high base with 1" leveling glides and a positive interlock system that permits only 1 drawer to open at a time. Drawers have full-extension ball-bearing slides and accommodate side-to-side and front-to-back filing of letter-, legal, and A4-size hanging files. Actual file widths are $29\frac{7}{8}$ ", $35\frac{7}{8}$ ", or $41\frac{7}{8}$ "; actual depth is $19\frac{7}{8}$ ".

Notes

For additional product options, see Vary Easy Program in Appendices.
Arc pull option (A.) conforms to guidelines of Americans with Disabilities Act (ADA).
Grain direction is vertical on veneer and wood-grain laminate fronts.
For information on counterweight option (CB), see Canvas Planning Guide.
For keyed-alike locks, see Keyed-Alike Information in Appendices.
No top (NT) option includes spacer kit that creates $\frac{1}{4}$ " reveal between the top of a wood pedestal, lateral file, or high credenza and a $1\frac{1}{4}$ "-thick worksurface placed at $28\frac{1}{4}$ " high. Worksurface ordered separately.

Dimensions

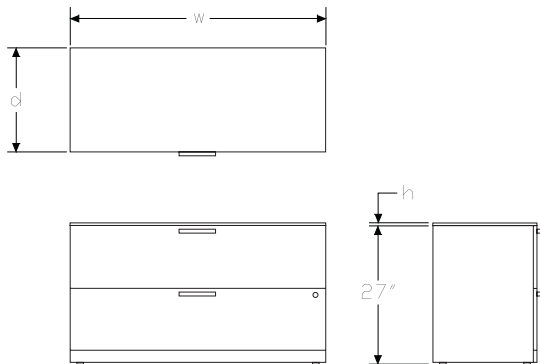

Specification Information

Step 1.

FF20 A

Step 2. Pull Type

A. arc pull A
K. bar pull A

Step 3. Width

30 30" wide A
36 36" wide A
42 42" wide A

Step 4. Depth

20 20" deep A

Step 5. Configuration

FF file/file A

Step 6. Base Height

2 $2\frac{1}{4}$ "-high base A

Step 7. Case/Front Material

L laminate A
C laminate case/veneer door A
W veneer A

Step 8. Top

For file/file (FF) with laminate (L)

NT no top A
03 $\frac{3}{8}$ " laminate top A
04 $\frac{3}{8}$ " veneer top A

For file/file (FF) with laminate case/veneer door (C)

NT no top A
03 $\frac{3}{8}$ " laminate top A
04 $\frac{3}{8}$ " veneer top A

For file/file (FF) with veneer (W)

NT no top A
04 $\frac{3}{8}$ " veneer top A

Step 9. Lock

L lock A

Wood Freestanding Lateral File

continued

Canvas Office Landscape® Wood Case Lateral Files

Prices for Steps 1-9.

	FF2LNTL	FF2L03L	FF2L04L	FF2CNTL	FF2C03L	FF2C04L
FF20A. 30 20	\$2286	2396	2616	2746	2855	3075
36 20	\$2506	2616	2836	3029	3138	3357
42 20	\$2726	2836	3055	3292	3403	3623

	FF2WNTL	FF2W04L
FF20A. 30 20	\$3098	3428
36 20	\$3438	3766
42 20	\$3754	4084

	FF2LNTL	FF2L03L	FF2L04L	FF2CNTL	FF2C03L	FF2C04L
FF20K. 30 20	\$2286	2396	2616	2746	2855	3075
36 20	\$2506	2616	2836	3029	3138	3357
42 20	\$2726	2836	3055	3292	3403	3623

	FF2WNTL	FF2W04L
FF20K. 30 20	\$3098	3428
36 20	\$3438	3766
42 20	\$3754	4084

Step 10. Case Finish

Solid-Color Laminate

For laminate (L) or laminate case/veneer door (C)

8Q	folkstone grey A	+\$0
91	white A	+\$0
98	studio white	+\$0
CL	cool grey neutral A	+\$0
LU	soft white A	+\$0
WL	sandstone A	+\$0
WN	warm grey neutral A	+\$0

Linen Laminate

For laminate (L) or laminate case/veneer door (C)

LBM	crisp linen	+\$0
LBN	classic linen	+\$0
LBP	casual linen	+\$0

Mesh Laminate

For laminate (L) or laminate case/veneer door (C)

LBK	pewter mesh	+\$0
LBL	steel mesh	+\$0

Twill Laminate

For laminate (L) or laminate case/veneer door (C)

LBF	neutral twill	+\$0
LBG	sarum twill	+\$0
LBH	earthen twill	+\$0
LBJ	graphite twill	+\$0
LBQ	white twill	+\$0

Wood-Grain Laminate

For laminate (L) or laminate case/veneer door (C)

HM	natural maple A	+\$0
HP	light anigre A	+\$0
LBA	clear on ash	+\$0
LBR	phantom ecru	+\$0
LBS	phantom cocoa	+\$0
LBU	medium matte walnut	+\$0
LBV	warm grey teak	+\$0
LBB	oak on ash	+\$0
LBC	walnut on ash	+\$0
LBD	dark brown walnut	+\$0
LBE	medium red walnut	+\$0
76	light brown walnut A	+\$0
HX	aged cherry A	+\$0
HY	walnut on cherry A	+\$0

Wood Veneer

For veneer (W)

2U	light brown walnut A	+\$0
40	dark brown walnut A	+\$0
ED	aged cherry A	+\$0
EK	medium red walnut A	+\$0
EW	medium matte walnut A	+\$0
ET	clear on ash A	+\$0
EU	oak on ash A	+\$0
EV	walnut on ash A	+\$0
UL	natural maple A	+\$0
UX	walnut on cherry A	+\$0

Wood Freestanding Lateral File

continued

Step 11. Front Finish

Solid-Color Laminate

For laminate (L)

8Q	folkstone grey <input type="checkbox"/>	+\$0
91	white <input type="checkbox"/>	+\$0
98	studio white	+\$0
CL	cool grey neutral <input type="checkbox"/>	+\$0
LU	soft white <input type="checkbox"/>	+\$0
WL	sandstone <input type="checkbox"/>	+\$0
WN	warm grey neutral <input type="checkbox"/>	+\$0

Linen Laminate

For laminate (L)

LBM	crisp linen	+\$0
LBN	classic linen	+\$0
LBP	casual linen	+\$0

Mesh Laminate

For laminate (L)

LBK	pewter mesh	+\$0
LBL	steel mesh	+\$0

Twill Laminate

For laminate (L)

LBF	neutral twill	+\$0
LBG	sarum twill	+\$0
LBH	earthen twill	+\$0
LBJ	graphite twill	+\$0
LBQ	white twill	+\$0

Wood-Grain Laminate

For laminate (L)

HM	natural maple <input type="checkbox"/>	+\$0
HP	light anigre <input type="checkbox"/>	+\$0
LBA	clear on ash	+\$0
LBR	phantom ecru	+\$0
LBS	phantom cocoa	+\$0
LBU	medium matte walnut	+\$0
LBV	warm grey teak	+\$0
LBB	oak on ash	+\$0
LBC	walnut on ash	+\$0
LBD	dark brown walnut	+\$0
LBE	medium red walnut	+\$0
76	light brown walnut <input type="checkbox"/>	+\$0
HX	aged cherry <input type="checkbox"/>	+\$0
HY	walnut on cherry <input type="checkbox"/>	+\$0

Wood Veneer

For laminate case/veneer door (C) or veneer (W)

2U	light brown walnut <input type="checkbox"/>	+\$0
40	dark brown walnut <input type="checkbox"/>	+\$0
ED	aged cherry <input type="checkbox"/>	+\$0
EK	medium red walnut <input type="checkbox"/>	+\$0
EW	medium matte walnut <input type="checkbox"/>	+\$0
ET	clear on ash <input type="checkbox"/>	+\$0
EU	oak on ash <input type="checkbox"/>	+\$0
EV	walnut on ash <input type="checkbox"/>	+\$0
UL	natural maple <input type="checkbox"/>	+\$0
UX	walnut on cherry <input type="checkbox"/>	+\$0

Step 12. Top Finish

Solid-Color Laminate

For 3/8" laminate top (03)

8Q	folkstone grey <input type="checkbox"/>	+\$0
91	white <input type="checkbox"/>	+\$0
98	studio white	+\$0
CL	cool grey neutral <input type="checkbox"/>	+\$0
LU	soft white <input type="checkbox"/>	+\$0
WL	sandstone <input type="checkbox"/>	+\$0
WN	warm grey neutral <input type="checkbox"/>	+\$0

Linen Laminate

For 3/8" laminate top (03)

LBM	crisp linen	+\$0
LBN	classic linen	+\$0
LBP	casual linen	+\$0

Mesh Laminate

For 3/8" laminate top (03)

LBK	pewter mesh	+\$0
LBL	steel mesh	+\$0

Twill Laminate

For 3/8" laminate top (03)

LBF	neutral twill	+\$0
LBG	sarum twill	+\$0
LBH	earthen twill	+\$0
LBJ	graphite twill	+\$0
LBQ	white twill	+\$0

Wood Freestanding Lateral File

continued

Wood-Grain Laminate

For $\frac{3}{8}$ " laminate top (03)

HM	natural maple <input type="checkbox"/>	+\$0
HP	light anigre <input type="checkbox"/>	+\$0
LBA	clear on ash	+\$0
LBR	phantom ecru	+\$0
LBS	phantom cocoa	+\$0
LBU	medium matte walnut	+\$0
LBV	warm grey teak	+\$0
LBB	oak on ash	+\$0
LBC	walnut on ash	+\$0
LBD	dark brown walnut	+\$0
LBE	medium red walnut	+\$0
76	light brown walnut <input type="checkbox"/>	+\$0
HX	aged cherry <input type="checkbox"/>	+\$0
HY	walnut on cherry <input type="checkbox"/>	+\$0

Wood Veneer

For $\frac{3}{8}$ " veneer top (04)

2U	light brown walnut <input type="checkbox"/>	+\$0
40	dark brown walnut <input type="checkbox"/>	+\$0
ED	aged cherry <input type="checkbox"/>	+\$0
EK	medium red walnut <input type="checkbox"/>	+\$0
EW	medium matte walnut <input type="checkbox"/>	+\$0
ET	clear on ash <input type="checkbox"/>	+\$0
EU	oak on ash <input type="checkbox"/>	+\$0
EV	walnut on ash <input type="checkbox"/>	+\$0
UL	natural maple <input type="checkbox"/>	+\$0
UX	walnut on cherry <input type="checkbox"/>	+\$0

Step 13. Pull Finish

For arc pull (A.)

NH	brushed nickel <input type="checkbox"/>	+\$0
NK	black nickel <input type="checkbox"/>	+\$0

Step 14. Pull Finish

For bar pull (K.)

8Q	folkstone grey	+\$0
91	white	+\$0
98	studio white <input type="checkbox"/>	+\$0
G1	graphite <input type="checkbox"/>	+\$0
WL	sandstone <input type="checkbox"/>	+\$0
CN	metallic champagne <input type="checkbox"/>	+\$0
MS	metallic silver <input type="checkbox"/>	+\$0
79	green apple <input type="checkbox"/>	+\$15
MY3	yellow oxide <input type="checkbox"/>	+\$15
RO	red <input type="checkbox"/>	+\$15
TRQ	turquoise <input type="checkbox"/>	+\$15

Step 15. Counterweight

NO	no counterweight <input type="checkbox"/>	+\$0
CB	counterweight <input type="checkbox"/>	+\$70

Step 16. Lock Option

KA	keyed alike <input type="checkbox"/>	-\$10
KC	keyed differently, chrome <input type="checkbox"/>	+\$0
KD	keyed differently, black <input type="checkbox"/>	+\$0

Wood Freestanding Pedestal

FF10A.
FF10K.

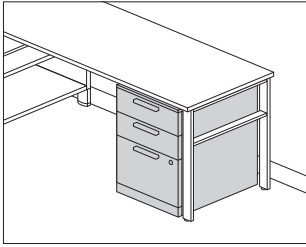

Product Information

Description

This pedestal has a $\frac{3}{8}$ "-high laminate or veneer top and the choice of a laminate case and front, veneer case and front, or laminate case with veneer front. It is available with 4"-high architectural feet or a $2\frac{1}{4}$ "-high base with 1" leveling glides. The drawers have full-extension ball-bearing slides. File drawers accommodate front-to-back filing of letter-size hanging files.

Actual pedestal depths are $19\frac{7}{8}$ ", $22\frac{7}{8}$ ", or $28\frac{7}{8}$ ".

Notes

For additional product options, see Vary Easy Program in Appendices.

Arc pull option (A.) conforms to guidelines of Americans with Disabilities Act (ADA).

Grain direction is vertical on veneer and wood-grain laminate fronts.

For keyed-alike locks, see Keyed-Alike Information in Appendices.

No top (NT) option includes spacer kit that creates $\frac{1}{4}$ " reveal between the top of a wood pedestal, lateral file, or high credenza and a $1\frac{1}{4}$ "-thick worksurface placed at $28\frac{1}{4}$ " high. Worksurface ordered separately.

Dimensions

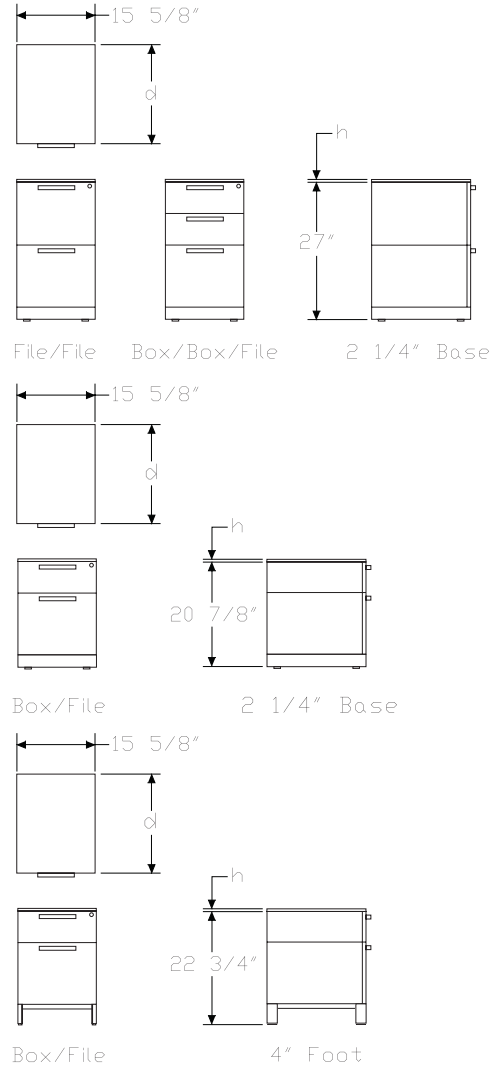

Wood Freestanding Pedestal

continued

Specification Information

Step 1.

FF10

Step 2. Pull Type

- A.** arc pull
- K.** bar pull

Step 3. Depth

- 20** 20" deep
- 24** 24" deep
- 30** 30" deep

Step 4. Configuration

- BBF** box/box/file
- FF** file/file
- BF** box/file

Step 5. Base/Foot Height

For box/box/file (BBF) or file/file (FF)

- 2** 2 1/4"-high base

For box/file (BF)

- 2** 2 1/4"-high base
- 4** 4"-high foot

Step 6. Case/Front Material

For 2 1/4"-high base (2)

- L** laminate case/front
- C** laminate case/veneer front
- W** veneer case/front

For 4"-high foot (4)

- L** laminate case/front
- C** laminate case/veneer front

Step 7. Top

For box/file (BF) with laminate case/front (L)

- 03** 3/8" laminate top
- 04** 3/8" veneer top

For box/file (BF) with laminate case/veneer front (C)

- 03** 3/8" laminate top
- 04** 3/8" veneer top

For box/file (BF) with veneer case/front (W)

- 04** 3/8" veneer top

For box/box/file (BBF) or file/file (FF) with laminate case/front (L)

- NT** no top
- 03** 3/8" laminate top
- 04** 3/8" veneer top

For box/box/file (BBF) or file/file (FF) with laminate case/veneer front (C)

- NT** no top
- 03** 3/8" laminate top
- 04** 3/8" veneer top

For box/box/file (BBF) or file/file (FF) with veneer case/front (W)

- NT** no top
- 04** 3/8" veneer top

Step 8. Lock

- L** lock

Prices for Steps 1-8.

		2LNTL	2L03L	2L04L	2CNTL	2C03L	2C04L	
FF10A. 20	BBF	\$1843	1929	2047	2226	2315	2519	
	FF	\$1784	1871	2075	2157	2246	2450	
	BF	—	\$1749	1953	—	2098	2303	
	24	BBF	\$1942	2028	2232	2348	2433	2637
		FF	\$1883	1970	2173	2276	2363	2568
		BF	—	\$1848	2052	—	2217	2420
	30	BBF	\$2122	2212	2424	2565	2654	2866
		FF	\$1982	2069	2273	2395	2482	2686
		BF	—	\$1947	2151	—	2335	2539
		2WNLT	2W04L	4L03L	4L04L	4C03L	4C04L	
FF10A. 20	BBF	\$2679	2897	—	—	—	—	
	FF	\$2591	2808	—	—	—	—	
	BF	—	\$2625	1778	1982	2098	2303	
	24	BBF	\$2829	3046	—	—	—	—
		FF	\$2688	2900	—	—	—	—
		BF	—	\$2773	1878	2080	2217	2420
	30	BBF	\$2977	3192	—	—	—	—
		FF	\$2889	3106	—	—	—	—
		BF	—	\$2922	1976	2180	2335	2539
		2LNTL	2L03L	2L04L	2CNTL	2C03L	2C04L	
FF10K. 20	BBF	\$1843	1929	2047	2226	2315	2519	
	FF	\$1784	1871	2075	2157	2246	2450	
	BF	—	\$1749	1953	—	2098	2303	

Wood Freestanding Pedestal

continued

24 BBF	\$1942	2028	2232	2348	2433	2637
FF	\$1883	1970	2173	2276	2363	2568
BF	—	\$1848	2052	—	2217	2420
30 BBF	\$2040	2127	2330	2466	2554	2754
FF	\$1982	2069	2273	2395	2482	2686
BF	—	\$1947	2151	—	2335	2539
	2WNTL	2W04L	4L03L	4L04L	4C03L	4C04L
FF10K. 20 BBF	\$2679	2897	—	—	—	—
FF	\$2591	2808	—	—	—	—
BF	—	\$2625	1778	1982	2098	2303
24 BBF	\$2829	3046	—	—	—	—
FF	\$2741	2957	—	—	—	—
BF	—	\$2773	1878	2080	2217	2420
30 BBF	\$2977	3192	—	—	—	—
FF	\$2889	3106	—	—	—	—
BF	—	\$2922	1976	2180	2335	2539

Step 9. Case Finish

Solid-Color Laminate

For laminate case/front (L) or laminate case/veneer front (C)

8Q	folkstone grey A	+\$0
91	white A	+\$0
98	studio white	+\$0
CL	cool grey neutral A	+\$0
LU	soft white A	+\$0
WL	sandstone A	+\$0
WN	warm grey neutral A	+\$0

Linen Laminate

For laminate case/front (L) or laminate case/veneer front (C)

LBM	crisp linen	+\$0
LBN	classic linen	+\$0
LBP	casual linen	+\$0

Mesh Laminate

For laminate case/front (L) or laminate case/veneer front (C)

LBK	pewter mesh	+\$0
LBL	steel mesh	+\$0

Twill Laminate

For laminate case/front (L) or laminate case/veneer front (C)

LBF	neutral twill	+\$0
LBG	sarum twill	+\$0
LBH	earthen twill	+\$0
LBJ	graphite twill	+\$0
LBQ	white twill	+\$0

Wood-Grain Laminate

For laminate case/front (L) or laminate case/veneer front (C)

HM	natural maple A	+\$0
HP	light anigre A	+\$0
LBA	clear on ash	+\$0
LBR	phantom ecru	+\$0
LBS	phantom cocoa	+\$0
LBU	medium matte walnut	+\$0
LBV	warm grey teak	+\$0
LBB	oak on ash	+\$0
LBC	walnut on ash	+\$0
LBD	dark brown walnut	+\$0
LBE	medium red walnut	+\$0
76	light brown walnut A	+\$0
HX	aged cherry A	+\$0
HY	walnut on cherry A	+\$0

Wood Veneer

For veneer case/front (W)

2U	light brown walnut A	+\$0
40	dark brown walnut A	+\$0
ED	aged cherry A	+\$0
EK	medium red walnut A	+\$0
EW	medium matte walnut A	+\$0
ET	clear on ash A	+\$0
EU	oak on ash A	+\$0
EV	walnut on ash A	+\$0
UL	natural maple A	+\$0
UX	walnut on cherry A	+\$0

Wood Freestanding Pedestal

continued

Canvas Office Landscape® Wood Case Pedestals

Step 10. Front Finish

Solid-Color Laminate		
<i>For laminate case/front (L)</i>		
8Q	folkstone grey <input type="checkbox"/> A	+\$0
91	white <input type="checkbox"/> A	+\$0
98	studio white	+\$0
CL	cool grey neutral <input type="checkbox"/> A	+\$0
LU	soft white <input type="checkbox"/> A	+\$0
WL	sandstone <input type="checkbox"/> A	+\$0
WN	warm grey neutral <input type="checkbox"/> A	+\$0

Linen Laminate		
<i>For laminate case/front (L)</i>		
LBM	crisp linen	+\$0
LBN	classic linen	+\$0
LBP	casual linen	+\$0

Mesh Laminate		
<i>For laminate case/front (L)</i>		
LBK	pewter mesh	+\$0
LBL	steel mesh	+\$0

Twill Laminate		
<i>For laminate case/front (L)</i>		
LBF	neutral twill	+\$0
LBG	sarum twill	+\$0
LBH	earthen twill	+\$0
LBJ	graphite twill	+\$0
LBQ	white twill	+\$0

Wood-Grain Laminate		
<i>For laminate case/front (L)</i>		
HM	natural maple <input type="checkbox"/> A	+\$0
HP	light anigre <input type="checkbox"/> A	+\$0
LBA	clear on ash	+\$0
LBR	phantom ecru	+\$0
LBS	phantom cocoa	+\$0
LBU	medium matte walnut	+\$0
LBV	warm grey teak	+\$0
LBB	oak on ash	+\$0
LBC	walnut on ash	+\$0
LBD	dark brown walnut	+\$0
LBE	medium red walnut	+\$0
76	light brown walnut <input type="checkbox"/> A	+\$0
HX	aged cherry <input type="checkbox"/> A	+\$0
HY	walnut on cherry <input type="checkbox"/> A	+\$0

Wood Veneer		
<i>For laminate case/veneer front (C) or veneer case/front (W)</i>		
2U	light brown walnut <input type="checkbox"/> A	+\$0
40	dark brown walnut <input type="checkbox"/> A	+\$0
ED	aged cherry <input type="checkbox"/> A	+\$0
EK	medium red walnut <input type="checkbox"/> A	+\$0
EW	medium matte walnut <input type="checkbox"/> A	+\$0
ET	clear on ash <input type="checkbox"/> A	+\$0
EU	oak on ash <input type="checkbox"/> A	+\$0
EV	walnut on ash <input type="checkbox"/> A	+\$0
UL	natural maple <input type="checkbox"/> A	+\$0
UX	walnut on cherry <input type="checkbox"/> A	+\$0

Step 11. Top Finish

Solid-Color Laminate		
<i>For ³/₈" laminate top (O3)</i>		
8Q	folkstone grey <input type="checkbox"/> A	+\$0
91	white <input type="checkbox"/> A	+\$0
98	studio white	+\$0
CL	cool grey neutral <input type="checkbox"/> A	+\$0
LU	soft white <input type="checkbox"/> A	+\$0
WL	sandstone <input type="checkbox"/> A	+\$0
WN	warm grey neutral <input type="checkbox"/> A	+\$0

Linen Laminate		
<i>For ³/₈" laminate top (O3)</i>		
LBM	crisp linen	+\$0
LBN	classic linen	+\$0
LBP	casual linen	+\$0

Mesh Laminate		
<i>For ³/₈" laminate top (O3)</i>		
LBK	pewter mesh	+\$0
LBL	steel mesh	+\$0

Twill Laminate		
<i>For ³/₈" laminate top (O3)</i>		
LBF	neutral twill	+\$0
LBG	sarum twill	+\$0
LBH	earthen twill	+\$0
LBJ	graphite twill	+\$0
LBQ	white twill	+\$0

Wood Freestanding Pedestal

continued

Wood-Grain Laminate

For $\frac{3}{8}$ " laminate top (03)

HM	natural maple <input type="checkbox"/>	+\$0
HP	light anigre <input type="checkbox"/>	+\$0
LBA	clear on ash	+\$0
LBR	phantom ecru	+\$0
LBS	phantom cocoa	+\$0
LBU	medium matte walnut	+\$0
LBV	warm grey teak	+\$0
LBB	oak on ash	+\$0
LBC	walnut on ash	+\$0
LBD	dark brown walnut	+\$0
LBE	medium red walnut	+\$0
76	light brown walnut <input type="checkbox"/>	+\$0
HX	aged cherry <input type="checkbox"/>	+\$0
HY	walnut on cherry <input type="checkbox"/>	+\$0

Wood Veneer

For $\frac{3}{8}$ " veneer top (04)

2U	light brown walnut <input type="checkbox"/>	+\$0
40	dark brown walnut <input type="checkbox"/>	+\$0
ED	aged cherry <input type="checkbox"/>	+\$0
EK	medium red walnut <input type="checkbox"/>	+\$0
EW	medium matte walnut <input type="checkbox"/>	+\$0
ET	clear on ash <input type="checkbox"/>	+\$0
EU	oak on ash <input type="checkbox"/>	+\$0
EV	walnut on ash <input type="checkbox"/>	+\$0
UL	natural maple <input type="checkbox"/>	+\$0
UX	walnut on cherry <input type="checkbox"/>	+\$0

Step 12. Foot Finish

For 4"-high foot (4)

Bright Sand Texture Paint

CL	cool grey neutral <input type="checkbox"/>	+\$0
WN	warm grey neutral <input type="checkbox"/>	+\$0
G1	graphite <input type="checkbox"/>	+\$0
91	white <input type="checkbox"/>	+\$0

Metallic Paint

MS	metallic silver <input type="checkbox"/>	+\$0
EH	metallic bronze <input type="checkbox"/>	+\$0
CN	metallic champagne <input type="checkbox"/>	+\$0

Step 13. Pull Finish

For arc pull (A.)

NH	brushed nickel <input type="checkbox"/>	+\$0
NK	black nickel <input type="checkbox"/>	+\$0

For bar pull (K.)

8Q	folkstone grey	+\$0
91	white	+\$0
98	studio white <input type="checkbox"/>	+\$0
G1	graphite <input type="checkbox"/>	+\$0
WL	sandstone <input type="checkbox"/>	+\$0
CN	metallic champagne <input type="checkbox"/>	+\$0
MS	metallic silver <input type="checkbox"/>	+\$0
79	green apple <input type="checkbox"/>	+\$15
MY3	yellow oxide <input type="checkbox"/>	+\$15
RO	red <input type="checkbox"/>	+\$15
TRQ	turquoise <input type="checkbox"/>	+\$15

Step 14. Counterweight

NO	no counterweight <input type="checkbox"/>	+\$0
CB	counterweight <input type="checkbox"/>	+\$24

Step 15. Lock Option

KA	keyed alike <input type="checkbox"/>	-\$10
KC	keyed differently, chrome <input type="checkbox"/>	+\$0
KD	keyed differently, black <input type="checkbox"/>	+\$0

Wood Mobile Pedestal

FF11A.
FF11K.

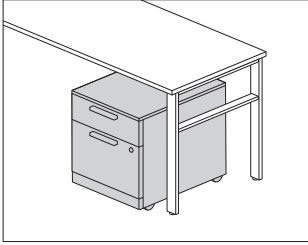

Canvas Office Landscape® Wood Case Pedestals

Product Information

Description

This pedestal has a 3/8"-high laminate or veneer top and the choice of a laminate case and front, veneer case and front, or laminate case with veneer front. It has concealed casters and full-extension ball-bearing slides on the drawers. File drawers accommodate front-to-back filing of letter-size hanging files.

Actual file depth is 17 7/8".

Notes

For additional product options, see Vary Easy Program in Appendices. Arc pull option (A.) conforms to guidelines of Americans with Disabilities Act (ADA).

Grain direction is vertical on veneer and wood-grain laminate fronts. For keyed-alike locks, see Keyed-Alike Information in Appendices.

Dimensions

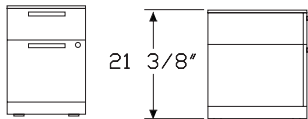
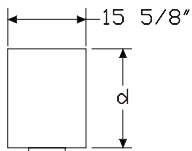

Box/File

Specification Information

Step 1.

FF11 A

Step 2. Pull Type

- A.** arc pull A
- K.** bar pull A

Step 3. Depth

18 18" deep A

Step 4. Configuration

BF box/file A

Step 5. Case/Front Material

- L** laminate case/front A
- C** laminate case/veneer front A
- W** veneer case/front A

Step 6. Top

For box/file (BF) with laminate case/front (L)

- 03** 3/8" laminate top A
- 04** 3/8" veneer top A

For box/file (BF) with laminate case/veneer front (C)

- 03** 3/8" laminate top A
- 04** 3/8" veneer top A

For box/file (BF) with veneer case/front (W)

- 04** 3/8" veneer top A

Step 7. Lock

L lock A

Prices for Steps 1-7.

	L03L	L04L	C03L	C04L	W04L
FF11A. 18 BF	\$1682	1881	1881	1994	2572
FF11K. 18 BF	\$1682	1881	1881	1994	2523

Wood Mobile Pedestal *continued*

Step 8. Case Finish

Solid-Color Laminate

For laminate case/front (L) or laminate case/veneer front (C)

8Q	folkstone grey <input type="checkbox"/>	+\$0
91	white <input type="checkbox"/>	+\$0
98	studio white	+\$0
CL	cool grey neutral <input type="checkbox"/>	+\$0
LU	soft white <input type="checkbox"/>	+\$0
WL	sandstone <input type="checkbox"/>	+\$0
WN	warm grey neutral <input type="checkbox"/>	+\$0

Linen Laminate

For laminate case/front (L) or laminate case/veneer front (C)

LBM	crisp linen	+\$0
LBN	classic linen	+\$0
LBP	casual linen	+\$0

Mesh Laminate

For laminate case/front (L) or laminate case/veneer front (C)

LBK	pewter mesh	+\$0
LBL	steel mesh	+\$0

Linen Laminate

For laminate case/front (L) or laminate case/veneer front (C)

LBF	neutral twill	+\$0
LBG	sarum twill	+\$0
LBH	earthen twill	+\$0
LBJ	graphite twill	+\$0
LBQ	white twill	+\$0

Wood-Grain Laminate

For laminate case/front (L) or laminate case/veneer front (C)

HM	natural maple <input type="checkbox"/>	+\$0
HP	light anigre <input type="checkbox"/>	+\$0
LBA	clear on ash	+\$0
LBR	phantom ecru	+\$0
LBS	phantom cocoa	+\$0
LBU	medium matte walnut	+\$0
LBV	warm grey teak	+\$0
LBB	oak on ash	+\$0
LBC	walnut on ash	+\$0
LBD	dark brown walnut	+\$0
LBE	medium red walnut	+\$0
76	light brown walnut <input type="checkbox"/>	+\$0
HX	aged cherry <input type="checkbox"/>	+\$0
HY	walnut on cherry <input type="checkbox"/>	+\$0

Wood Veneer

For veneer case/front (W)

2U	light brown walnut <input type="checkbox"/>	+\$0
40	dark brown walnut <input type="checkbox"/>	+\$0
ED	aged cherry <input type="checkbox"/>	+\$0
EK	medium red walnut <input type="checkbox"/>	+\$0
EW	medium matte walnut <input type="checkbox"/>	+\$0
ET	clear on ash <input type="checkbox"/>	+\$0
EU	oak on ash <input type="checkbox"/>	+\$0
EV	walnut on ash <input type="checkbox"/>	+\$0
UL	natural maple <input type="checkbox"/>	+\$0
UX	walnut on cherry <input type="checkbox"/>	+\$0

Step 9. Front Finish

Solid-Color Laminate

For laminate case/front (L)

8Q	folkstone grey <input type="checkbox"/>	+\$0
91	white <input type="checkbox"/>	+\$0
98	studio white	+\$0
CL	cool grey neutral <input type="checkbox"/>	+\$0
LU	soft white <input type="checkbox"/>	+\$0
WL	sandstone <input type="checkbox"/>	+\$0
WN	warm grey neutral <input type="checkbox"/>	+\$0

Linen Laminate

For laminate case/front (L)

LBM	crisp linen	+\$0
LBN	classic linen	+\$0
LBP	casual linen	+\$0

Mesh Laminate

For laminate case/front (L)

LBK	pewter mesh	+\$0
LBL	steel mesh	+\$0

Twill Laminate

For laminate case/front (L)

LBF	neutral twill	+\$0
LBG	sarum twill	+\$0
LBH	earthen twill	+\$0
LBJ	graphite twill	+\$0
LBQ	white twill	+\$0

Wood Mobile Pedestal *continued*

Wood-Grain Laminate		
<i>For laminate case/front (L)</i>		
HM	natural maple A	+\$0
HP	light anigre A	+\$0
LBA	clear on ash	+\$0
LBR	phantom ecru	+\$0
LBS	phantom cocoa	+\$0
LBU	medium matte walnut	+\$0
LBV	warm grey teak	+\$0
LBB	oak on ash	+\$0
LBC	walnut on ash	+\$0
LBD	dark brown walnut	+\$0
LBE	medium red walnut	+\$0
76	light brown walnut A	+\$0
HX	aged cherry A	+\$0
HY	walnut on cherry A	+\$0

Wood Veneer		
<i>For laminate case/veneer front (C) or veneer case/front (W)</i>		
2U	light brown walnut A	+\$0
40	dark brown walnut A	+\$0
ED	aged cherry A	+\$0
EK	medium red walnut A	+\$0
EW	medium matte walnut A	+\$0
ET	clear on ash A	+\$0
EU	oak on ash A	+\$0
EV	walnut on ash A	+\$0
UL	natural maple A	+\$0
UX	walnut on cherry A	+\$0

Step 10. Top Finish

Solid-Color Laminate		
<i>For 3/8" laminate top (03)</i>		
8Q	folkstone grey A	+\$0
91	white A	+\$0
98	studio white	+\$0
CL	cool grey neutral A	+\$0
LU	soft white A	+\$0
WL	sandstone A	+\$0
WN	warm grey neutral A	+\$0

Linen Laminate		
<i>For 3/8" laminate top (03)</i>		
LBM	crisp linen	+\$0
LBN	classic linen	+\$0
LBP	casual linen	+\$0

Mesh Laminate		
<i>For 3/8" laminate top (03)</i>		
LBK	pewter mesh	+\$0
LBL	steel mesh	+\$0

Twill Laminate		
<i>For 3/8" laminate top (03)</i>		
LBF	neutral twill	+\$0
LBG	sarum twill	+\$0
LBH	earthen twill	+\$0
LBJ	graphite twill	+\$0
LBQ	white twill	+\$0

Wood-Grain Laminate		
<i>For 3/8" laminate top (03)</i>		
HM	natural maple A	+\$0
HP	light anigre A	+\$0
LBA	clear on ash	+\$0
LBB	oak on ash	+\$0
LBC	walnut on ash	+\$0
LBD	dark brown walnut	+\$0
LBR	phantom ecru	+\$0
LBS	phantom cocoa	+\$0
LBU	medium matte walnut	+\$0
LBV	warm grey teak	+\$0
LBE	medium red walnut	+\$0
76	light brown walnut A	+\$0
HX	aged cherry A	+\$0
HY	walnut on cherry A	+\$0

Wood Veneer		
<i>For 3/8" veneer top (04)</i>		
2U	light brown walnut A	+\$0
40	dark brown walnut A	+\$0
ED	aged cherry A	+\$0
EK	medium red walnut A	+\$0
EW	medium matte walnut A	+\$0
ET	clear on ash A	+\$0
EU	oak on ash A	+\$0
EV	walnut on ash A	+\$0
UL	natural maple A	+\$0
UX	walnut on cherry A	+\$0

Wood Mobile Pedestal *continued*

Step 11. Pull Finish

For arc pull (A.)

NH	brushed nickel <input type="checkbox"/>	+\$0
NK	black nickel <input type="checkbox"/>	+\$0

For bar pull (K.)

8Q	folkstone grey	+\$0
91	white	+\$0
98	studio white <input type="checkbox"/>	+\$0
G1	graphite <input type="checkbox"/>	+\$0
WL	sandstone <input type="checkbox"/>	+\$0
CN	metallic champagne <input type="checkbox"/>	+\$0
MS	metallic silver <input type="checkbox"/>	+\$0
79	green apple <input type="checkbox"/>	+\$15
MY3	yellow oxide <input type="checkbox"/>	+\$15
RO	red <input type="checkbox"/>	+\$15
TRQ	turquoise <input type="checkbox"/>	+\$15

Step 12. Lock Option

KA	keyed alike <input type="checkbox"/>	-\$10
KC	keyed differently, chrome <input type="checkbox"/>	+\$0
KD	keyed differently, black <input type="checkbox"/>	+\$0

Pedestal Cushion Top

FF893.

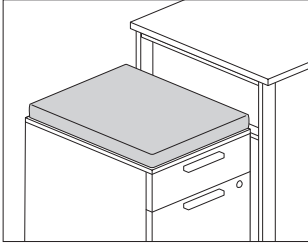

Canvas Office Landscape® Wood Case Pedestals

Product Information

Description
This cushion attaches to the top of a wood freestanding or mobile pedestal to provide temporary guest seating. Attachment hardware included.

Notes
Pedestal cushion accepts Customer's Own Material (COM). Yardage is estimated for nondirectional, 54"-wide fabrics. Order 1/2 yard of fabric per cushion. For odd number of cushions, round up to next full yard. For information on multiple quantities or directional fabrics, contact COM Department. See Order Information in Appendices.

Dimensions

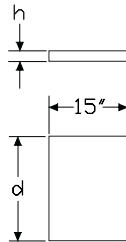

Specification Information

Step 1.

FF893. [A]

Step 2. Height

01 1" high [A]

02 2" high [A]

Step 3. Depth

18 18" deep [A]

20 20" deep [A]

24 24" deep [A]

30 30" deep [A]

Prices for Steps 1-3.

	18	20	24	30
FF893. 01	\$151	219	223	235
02	\$249	261	265	285

Step 4. Fabric

See application chart and textiles list for fabric usage and numbers. First 2 digits of number indicate fabric line; remaining digit(s) indicate fabric color.

Price Category 1	+\$0
Price Category 2	+\$43
Price Category 3	+\$60
Price Category 4	+\$79
Price Category 5	+\$103
Price Category 7	+\$144
Price Category 8	+\$146
Price Category 9	+\$956
Price Category (Geiger) 10	+\$1081
Price Category B	+\$29
Price Category C	+\$39
Price Category D	+\$51
Price Category E	+\$61
Price Category F	+\$79
Price Category G	+\$103
Price Category H	+\$125
Price Category I	+\$147
Price Category J	+\$169
Price Category K	+\$191

Wood Vertical Tower

FF52M.

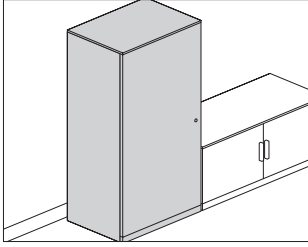

Product Information

Description

This freestanding tower is fully enclosed and has a variety of interior configurations with options for file drawers with wardrobe and shelves. It is available with a 2 1/4"-high base or 4"-high architectural feet with 1" leveling glides. Top options are a finished case top or 3/8" laminate or veneer thin top. Towers 15" wide or 24" wide have a single door; 30"- and 36"-wide towers have 2 asymmetrical doors, 1 for the wardrobe and 1 for shelves/drawers. Tower doors have touch latches and optional locks.

Notes

Tower with finished case top aligns with top of bead on a frame attached tile. Adding a thin top increases overall tower height 1/2".
Align like components next to like units: Finished case units with other finished case units, thin top units with other thin top units, 2 1/4" base storage units with other 2 1/4" base storage, and 4" foot storage with other 4" foot storage.
Tower matches style of wood overhead storage cabinet, open (FV43C.) or overhead storage cabinet, hinged doors (FV43H.).
Actual tower widths are 14 7/8" (15), 23 7/8" (24), 29 7/8" (30), or 35 7/8" (36); actual depths are 14 7/8" (1), 19 7/8" (2), or 23 7/8" (4).
• 15" deep (1) matches overhead storage unit (FV43X) depth.
• 20 deep (2) matches Canvas low storage depth.
• 24 deep (4) matches Canvas rectangular work surface at 24" deep, no gap.

Wardrobe includes coat hook.

Storage compartment has 1 or more adjustable shelves that adjust in 1 1/4" increments.

Drawers have full-extension ball-bearing slides. File drawers in 15"-wide tower accommodate side-to-side filing of letter-size hanging files. File drawers in 24", 30"- and 36"-wide towers accommodate front-to-back filing of letter-size hanging files.

Tower case is available in laminate or veneer; doors in laminate, veneer, or back-painted glass; 3/8" thin top in laminate or veneer.

Glass doors are back-painted and writable with dry-erase marker. Glass doors cannot lock.

Grain direction is vertical on veneer, wood-grain, and patterned laminate case and fronts.

Dimensional illustration does not include all possible configurations.

For keyed-alike locks, see Keyed-Alike Information in appendices.

Dimensions

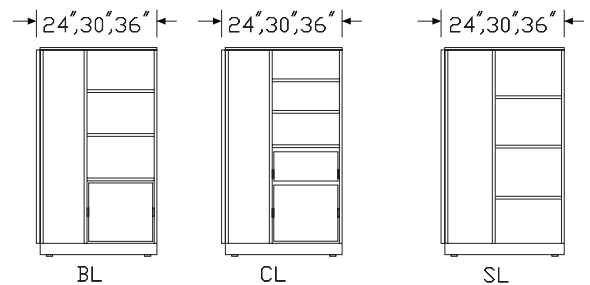
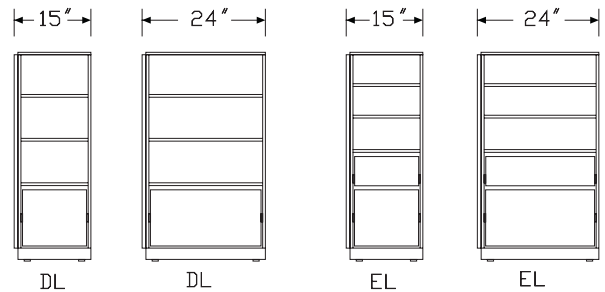
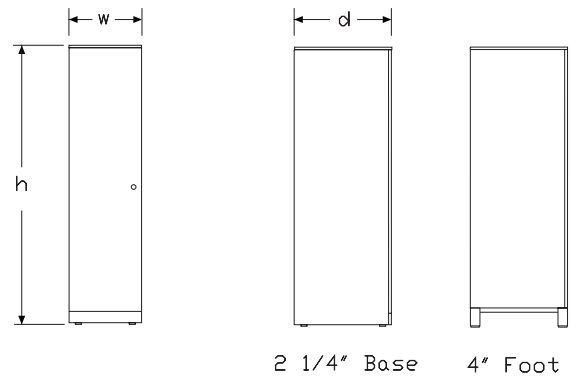

Wood Vertical Tower *continued*

Specification Information		
Step 1.		
FF52M. <input type="checkbox"/>		
Step 2. Height		
3	42" high <input type="checkbox"/>	+\$500
4	46" high <input type="checkbox"/>	+\$600
5	53" high <input type="checkbox"/>	+\$700
6	57" high <input type="checkbox"/>	+\$800
7	68" high <input type="checkbox"/>	+\$900
Step 3. Width		
15	15" wide <input type="checkbox"/>	+\$300
24	24" wide <input type="checkbox"/>	+\$400
30	30" wide <input type="checkbox"/>	+\$500
36	36" wide <input type="checkbox"/>	+\$600
Step 4. Depth		
<i>For 15" wide (15)</i>		
2	20" deep <input type="checkbox"/>	+\$100
4	24" deep <input type="checkbox"/>	+\$300
<i>For 24" wide (24), 30" wide (30), or 36" wide (36)</i>		
1	15" deep <input type="checkbox"/>	+\$200
2	20" deep <input type="checkbox"/>	+\$250
4	24" deep <input type="checkbox"/>	+\$360
Step 5. Base/Foot Height		
2	2 ¹ / ₄ "-high base <input type="checkbox"/>	+\$100
4	4"-high foot <input type="checkbox"/>	+\$200
Step 6. Configuration		
<i>For 15" wide (15) with 20" deep (2) or 24" deep (4)</i>		
EL	shelves/box(s)/file, left-hinged door <input type="checkbox"/>	+\$175
ER	shelves/box(s)/file, right-hinged door <input type="checkbox"/>	+\$175
DL	shelves/file(s), left-hinged door <input type="checkbox"/>	+\$200
DR	shelves/file(s), right-hinged door <input type="checkbox"/>	+\$200
<i>For 24" wide (24), 30" wide (30), or 36" wide (36) with 15" deep (1)</i>		
SL	wardrobe left, shelves right <input type="checkbox"/>	+\$325
SR	shelves left, wardrobe right <input type="checkbox"/>	+\$325

<i>For 24" wide (24) with 20" deep (2) or 24" deep (4)</i>		
CL	wardrobe left, shelves/box(s)/file right <input type="checkbox"/>	+\$175
CR	shelves/box(s)/file left, wardrobe right <input type="checkbox"/>	+\$175
BL	wardrobe left, shelves/file(s) right <input type="checkbox"/>	+\$200
BR	shelves/file(s) left, wardrobe right <input type="checkbox"/>	+\$200
EL	shelves/box(s)/file, left-hinged door <input type="checkbox"/>	+\$200
ER	shelves/box(s)/file, right-hinged door <input type="checkbox"/>	+\$200
DL	shelves/file(s), left-hinged door <input type="checkbox"/>	+\$225
DR	shelves/file(s), right-hinged door <input type="checkbox"/>	+\$225
SL	wardrobe left, shelves right <input type="checkbox"/>	+\$225
SR	shelves left, wardrobe right <input type="checkbox"/>	+\$225
<i>For 30" wide (30) or 36" wide (36) with 20" deep (2) or 24" deep (4)</i>		
CL	wardrobe left, shelves/box(s)/file right <input type="checkbox"/>	+\$250
CR	shelves/box(s)/file left, wardrobe right <input type="checkbox"/>	+\$250
SL	wardrobe left, shelves right <input type="checkbox"/>	+\$250
SR	shelves left, wardrobe right <input type="checkbox"/>	+\$250
BL	wardrobe left, shelves/file(s) right <input type="checkbox"/>	+\$275
BR	shelves/file(s) left, wardrobe right <input type="checkbox"/>	+\$275
Step 7. Case/Door Material		
<i>For 42" high (3), 46" high (4), or 53" high (5) with 15" wide (15)</i>		
L	laminata case and doors <input type="checkbox"/>	+\$575
C	laminata case/veneer doors <input type="checkbox"/>	+\$700
G	laminata case/glass doors <input type="checkbox"/>	+\$1175
W	veneer case and doors <input type="checkbox"/>	+\$1800
R	veneer case/glass doors <input type="checkbox"/>	+\$2100
<i>For 42" high (3), 46" high (4), or 53" high (5) with 24" wide (24)</i>		
L	laminata case and doors <input type="checkbox"/>	+\$845
C	laminata case/veneer doors <input type="checkbox"/>	+\$1350
G	laminata case/glass doors <input type="checkbox"/>	+\$1445
W	veneer case and doors <input type="checkbox"/>	+\$3300
R	veneer case/glass doors <input type="checkbox"/>	+\$3600
<i>For 42" high (3), 46" high (4), or 53" high (5) with 30" wide (30)</i>		
L	laminata case and doors <input type="checkbox"/>	+\$850
C	laminata case/veneer doors <input type="checkbox"/>	+\$1425
G	laminata case/glass doors <input type="checkbox"/>	+\$2850
W	veneer case and doors <input type="checkbox"/>	+\$3400
R	veneer case/glass doors <input type="checkbox"/>	+\$4500

Wood Vertical Tower *continued*

For 42" high (3), 46" high (4), or 53" high (5) with 36" wide (36)		
L	laminate case and doors <input type="checkbox"/> A	+\$1000
C	laminate case/veneer doors <input type="checkbox"/> A	+\$1900
G	laminate case/glass doors <input type="checkbox"/> A	+\$3000
W	veneer case and doors <input type="checkbox"/> A	+\$3500
R	veneer case/glass doors <input type="checkbox"/> A	+\$4600

For 57" high (6) or 68" high (7) with 15" wide (15)		
L	laminate case and doors <input type="checkbox"/> A	+\$700
C	laminate case/veneer doors <input type="checkbox"/> A	+\$1000
G	laminate case/glass doors <input type="checkbox"/> A	+\$2700
W	veneer case and doors <input type="checkbox"/> A	+\$2000
R	veneer case/glass doors <input type="checkbox"/> A	+\$3000

For 57" high (6) or 68" high (7) with 24" wide (24)		
L	laminate case and doors <input type="checkbox"/> A	+\$795
C	laminate case/veneer doors <input type="checkbox"/> A	+\$1125
G	laminate case/glass doors <input type="checkbox"/> A	+\$2795
W	veneer case and doors <input type="checkbox"/> A	+\$3200
R	veneer case/glass doors <input type="checkbox"/> A	+\$4200

For 57" high (6) or 68" high (7) with 30" wide (30)		
L	laminate case and doors <input type="checkbox"/> A	+\$800
C	laminate case/veneer doors <input type="checkbox"/> A	+\$1150
G	laminate case/glass doors <input type="checkbox"/> A	+\$3300
W	veneer case and doors <input type="checkbox"/> A	+\$3350
R	veneer case/glass doors <input type="checkbox"/> A	+\$4850

For 57" high (6) or 68" high (7) with 36" wide (36)		
L	laminate case and doors <input type="checkbox"/> A	+\$1000
C	laminate case/veneer doors <input type="checkbox"/> A	+\$1425
G	laminate case/glass doors <input type="checkbox"/> A	+\$3500
W	veneer case and doors <input type="checkbox"/> A	+\$3450
R	veneer case/glass doors <input type="checkbox"/> A	+\$4950

Step 8. Base Material		
L	laminate <input type="checkbox"/> A	+\$100
W	veneer <input type="checkbox"/> A	+\$150

Step 9. Top		
T	finished case top <input type="checkbox"/> A	+\$0
3	3/8" laminate thin top <input type="checkbox"/> A	+\$150
4	3/8" veneer thin top <input type="checkbox"/> A	+\$300

Step 10. Lock		
L	lock <input type="checkbox"/> A	+\$0
N	no lock <input type="checkbox"/> A	+\$0

Step 11. Case/Edge Finish

For laminate case and doors (L), laminate case/veneer doors (C), or laminate case/glass doors (G)

76	light brown walnut <input type="checkbox"/> A	+\$0
8Q	folkstone grey <input type="checkbox"/> A	+\$0
91	white <input type="checkbox"/> A	+\$0
98	studio white <input type="checkbox"/> A	+\$0
CL	cool grey neutral <input type="checkbox"/> A	+\$0
HM	natural maple <input type="checkbox"/> A	+\$0
HP	light anigre <input type="checkbox"/> A	+\$0
HX	aged cherry <input type="checkbox"/> A	+\$0
HY	walnut on cherry <input type="checkbox"/> A	+\$0
LA	light ash <input type="checkbox"/> A	+\$0
LBA	clear on ash <input type="checkbox"/> A	+\$0
LBR	phantom ecru <input type="checkbox"/> A	+\$0
LBS	phantom cocoa <input type="checkbox"/> A	+\$0
LBU	medium matte walnut <input type="checkbox"/> A	+\$0
LBV	warm grey teak <input type="checkbox"/> A	+\$0
LBB	oak on ash <input type="checkbox"/> A	+\$0
LBC	walnut on ash <input type="checkbox"/> A	+\$0
LBD	dark brown walnut <input type="checkbox"/> A	+\$0
LBE	medium red walnut <input type="checkbox"/> A	+\$0
LBF	neutral twill <input type="checkbox"/> A	+\$0
LBG	sarum twill <input type="checkbox"/> A	+\$0
LBH	earthen twill <input type="checkbox"/> A	+\$0
LBJ	graphite twill <input type="checkbox"/> A	+\$0
LBK	pewter mesh <input type="checkbox"/> A	+\$0
LBL	steel mesh <input type="checkbox"/> A	+\$0
LBM	crisp linen <input type="checkbox"/> A	+\$0
LBN	classic linen <input type="checkbox"/> A	+\$0
LBP	casual linen <input type="checkbox"/> A	+\$0
LBQ	white twill <input type="checkbox"/> A	+\$0
LU	soft white <input type="checkbox"/> A	+\$0
WL	sandstone <input type="checkbox"/> A	+\$0
WN	warm grey neutral <input type="checkbox"/> A	+\$0

Wood Veneer

For veneer case and doors (W) or veneer case/glass doors (R)

2U	light brown walnut <input type="checkbox"/>	+\$0
40	dark brown walnut <input type="checkbox"/>	+\$0
ED	aged cherry <input type="checkbox"/>	+\$0
EK	medium red walnut <input type="checkbox"/>	+\$0
EW	medium matte walnut <input type="checkbox"/>	+\$0
ET	clear on ash <input type="checkbox"/>	+\$0
EU	oak on ash <input type="checkbox"/>	+\$0
EV	walnut on ash <input type="checkbox"/>	+\$0
UL	natural maple <input type="checkbox"/>	+\$0
UX	walnut on cherry <input type="checkbox"/>	+\$0

Step 12. Door/Edge Finish

For laminate case and doors (L)

76	light brown walnut <input type="checkbox"/>	+\$0
8Q	folkstone grey <input type="checkbox"/>	+\$0
91	white <input type="checkbox"/>	+\$0
98	studio white <input type="checkbox"/>	+\$0
CL	cool grey neutral <input type="checkbox"/>	+\$0
HM	natural maple <input type="checkbox"/>	+\$0
HP	light anigre <input type="checkbox"/>	+\$0
HX	aged cherry <input type="checkbox"/>	+\$0
HY	walnut on cherry <input type="checkbox"/>	+\$0
LA	light ash <input type="checkbox"/>	+\$0
LBA	clear on ash <input type="checkbox"/>	+\$0
LBR	phantom ecru <input type="checkbox"/>	+\$0
LBS	phantom cocoa <input type="checkbox"/>	+\$0
LBU	medium matte walnut <input type="checkbox"/>	+\$0
LBV	warm grey teak <input type="checkbox"/>	+\$0
LBB	oak on ash <input type="checkbox"/>	+\$0
LBC	walnut on ash <input type="checkbox"/>	+\$0
LBD	dark brown walnut <input type="checkbox"/>	+\$0
LBE	medium red walnut <input type="checkbox"/>	+\$0
LBF	neutral twill <input type="checkbox"/>	+\$0
LBG	sarum twill <input type="checkbox"/>	+\$0
LBH	earthen twill <input type="checkbox"/>	+\$0
LBJ	graphite twill <input type="checkbox"/>	+\$0
LBK	pewter mesh <input type="checkbox"/>	+\$0
LBL	steel mesh <input type="checkbox"/>	+\$0
LBM	crisp linen <input type="checkbox"/>	+\$0
LBN	classic linen <input type="checkbox"/>	+\$0
LBP	casual linen <input type="checkbox"/>	+\$0
LBQ	white twill <input type="checkbox"/>	+\$0
LU	soft white <input type="checkbox"/>	+\$0
WL	sandstone <input type="checkbox"/>	+\$0
WN	warm grey neutral <input type="checkbox"/>	+\$0

Wood Veneer

For laminate case/veneer doors (C) or veneer case and doors (W)

2U	light brown walnut <input type="checkbox"/>	+\$0
40	dark brown walnut <input type="checkbox"/>	+\$0
ED	aged cherry <input type="checkbox"/>	+\$0
EK	medium red walnut <input type="checkbox"/>	+\$0
EW	medium matte walnut <input type="checkbox"/>	+\$0
ET	clear on ash <input type="checkbox"/>	+\$0
EU	oak on ash <input type="checkbox"/>	+\$0
EV	walnut on ash <input type="checkbox"/>	+\$0
UL	natural maple <input type="checkbox"/>	+\$0
UX	walnut on cherry <input type="checkbox"/>	+\$0

Glass

For laminate case/glass doors (G) or veneer case/glass doors (R)

8Q	folkstone grey <input type="checkbox"/>	+\$0
91	white <input type="checkbox"/>	+\$0
98	studio white <input type="checkbox"/>	+\$0

Step 13. Top/Edge Finish

For 3/8" laminate thin top (3)

76	light brown walnut <input type="checkbox"/>	+\$0
8Q	folkstone grey <input type="checkbox"/>	+\$0
91	white <input type="checkbox"/>	+\$0
98	studio white <input type="checkbox"/>	+\$0
CL	cool grey neutral <input type="checkbox"/>	+\$0
HM	natural maple <input type="checkbox"/>	+\$0
HP	light anigre <input type="checkbox"/>	+\$0
HX	aged cherry <input type="checkbox"/>	+\$0
HY	walnut on cherry <input type="checkbox"/>	+\$0
LA	light ash <input type="checkbox"/>	+\$0
LBA	clear on ash <input type="checkbox"/>	+\$0
LBR	phantom ecru <input type="checkbox"/>	+\$0
LBS	phantom cocoa <input type="checkbox"/>	+\$0
LBU	medium matte walnut <input type="checkbox"/>	+\$0
LBV	warm grey teak <input type="checkbox"/>	+\$0
LBB	oak on ash <input type="checkbox"/>	+\$0
LBC	walnut on ash <input type="checkbox"/>	+\$0
LBD	dark brown walnut <input type="checkbox"/>	+\$0
LBE	medium red walnut <input type="checkbox"/>	+\$0
LBF	neutral twill <input type="checkbox"/>	+\$0
LBG	sarum twill <input type="checkbox"/>	+\$0
LBH	earthen twill <input type="checkbox"/>	+\$0
LBJ	graphite twill <input type="checkbox"/>	+\$0
LBK	pewter mesh <input type="checkbox"/>	+\$0
LBL	steel mesh <input type="checkbox"/>	+\$0
LBM	crisp linen <input type="checkbox"/>	+\$0
LBN	classic linen <input type="checkbox"/>	+\$0
LBP	casual linen <input type="checkbox"/>	+\$0
LBQ	white twill <input type="checkbox"/>	+\$0
LU	soft white <input type="checkbox"/>	+\$0
WL	sandstone <input type="checkbox"/>	+\$0
WN	warm grey neutral <input type="checkbox"/>	+\$0

Wood Veneer

For 3/8" veneer thin top (4)

2U	light brown walnut <input type="checkbox"/>	+\$0
40	dark brown walnut <input type="checkbox"/>	+\$0
ED	aged cherry <input type="checkbox"/>	+\$0
EK	medium red walnut <input type="checkbox"/>	+\$0
EW	medium matte walnut <input type="checkbox"/>	+\$0
ET	clear on ash <input type="checkbox"/>	+\$0
EU	oak on ash <input type="checkbox"/>	+\$0
EV	walnut on ash <input type="checkbox"/>	+\$0
UL	natural maple <input type="checkbox"/>	+\$0
UX	walnut on cherry <input type="checkbox"/>	+\$0

Step 14. Base/Foot/Edge Finish

Bright Sand Texture Paint

For 4"-high foot (4)

91	white <input type="checkbox"/>	+\$0
CL	cool grey neutral <input type="checkbox"/>	+\$0
G1	graphite <input type="checkbox"/>	+\$0
WN	warm grey neutral <input type="checkbox"/>	+\$0

Metallic Paint

For 4"-high foot (4)

CN	metallic champagne <input type="checkbox"/>	+\$0
EH	metallic bronze <input type="checkbox"/>	+\$0
MS	metallic silver <input type="checkbox"/>	+\$0

For 2 1/4"-high base (2) with laminate (L)

76	light brown walnut <input type="checkbox"/>	+\$0
8Q	folkstone grey <input type="checkbox"/>	+\$0
91	white <input type="checkbox"/>	+\$0
98	studio white <input type="checkbox"/>	+\$0
CL	cool grey neutral <input type="checkbox"/>	+\$0
HM	natural maple <input type="checkbox"/>	+\$0
HP	light anigre <input type="checkbox"/>	+\$0
HX	aged cherry <input type="checkbox"/>	+\$0
HY	walnut on cherry <input type="checkbox"/>	+\$0
LA	light ash <input type="checkbox"/>	+\$0
LBA	clear on ash <input type="checkbox"/>	+\$0
LBR	phantom ecru <input type="checkbox"/>	+\$0
LBS	phantom cocoa <input type="checkbox"/>	+\$0
LBU	medium matte walnut <input type="checkbox"/>	+\$0
LBV	warm grey teak <input type="checkbox"/>	+\$0
LBB	oak on ash <input type="checkbox"/>	+\$0
LBC	walnut on ash <input type="checkbox"/>	+\$0
LBD	dark brown walnut <input type="checkbox"/>	+\$0
LBE	medium red walnut <input type="checkbox"/>	+\$0
LBF	neutral twill <input type="checkbox"/>	+\$0
LBG	sarum twill <input type="checkbox"/>	+\$0
LBH	earthen twill <input type="checkbox"/>	+\$0
LBJ	graphite twill <input type="checkbox"/>	+\$0
LBK	pewter mesh <input type="checkbox"/>	+\$0
LBL	steel mesh <input type="checkbox"/>	+\$0
LBM	crisp linen <input type="checkbox"/>	+\$0
LBN	classic linen <input type="checkbox"/>	+\$0
LBP	casual linen <input type="checkbox"/>	+\$0
LBQ	white twill <input type="checkbox"/>	+\$0
LU	soft white <input type="checkbox"/>	+\$0
WL	sandstone <input type="checkbox"/>	+\$0
WN	warm grey neutral <input type="checkbox"/>	+\$0

Wood Veneer

For 2 1/4"-high base (2) with veneer (W)

2U	light brown walnut <input type="checkbox"/>	+\$0
40	dark brown walnut <input type="checkbox"/>	+\$0
ED	aged cherry <input type="checkbox"/>	+\$0
EK	medium red walnut <input type="checkbox"/>	+\$0
EW	medium matte walnut <input type="checkbox"/>	+\$0
ET	clear on ash <input type="checkbox"/>	+\$0
EU	oak on ash <input type="checkbox"/>	+\$0
EV	walnut on ash <input type="checkbox"/>	+\$0
UL	natural maple <input type="checkbox"/>	+\$0
UX	walnut on cherry <input type="checkbox"/>	+\$0

Wood Vertical Tower *continued*

Step 15. Lock Option

For lock (L)

KA	keyed alike <input type="checkbox"/>	-\$10
KC	keyed differently, chrome <input type="checkbox"/>	+\$0
KD	keyed differently, black <input type="checkbox"/>	+\$0

Wood Vertical Tower with Lower Storage FF53M.

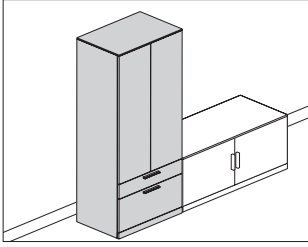

Product Information

Description

This freestanding tower has upper doors and lower exposed drawer storage, and comes in a variety of interior configurations with options for wardrobe and shelves. It is available with a 2 1/4"-high base or 4"-high architectural feet with 1" leveling glides. Top options are a finished case top or 3/8" laminate or veneer thin top. 16" wide tower has a single door; 30", 36"- and 42"-wide towers have 2 symmetrical doors. Tower doors have touch latches and optional locks. Drawers have bar pulls.

Notes

Tower with finished case top aligns with top of bead on a frame attached tile. Adding a thin top increases overall tower height 1/2". Align like components next to like units: Finished case units with other finished case units, thin top units with other thin top units, 2 1/4" base storage units with other 2 1/4" base storage, and 4" foot storage with other 4" foot storage.

Tower matches style of wood overhead storage cabinet, open (FV43C.) or overhead storage cabinet, hinged doors (FV43H.).

Actual tower widths are 15 5/8" (16), 29 7/8" (30), 35 7/8" (36), or 41 7/8" (42); actual depths are 19 7/8" (2), or 23 7/8" (4).

- 20" deep (2) matches Canvas low storage depth.
- 24" deep (4) matches Canvas rectangular work surface at 24" deep, no gap.

Wardrobe includes coat hook.

Lower drawers are available in box/file, box/box/file, or file/file combinations.

Storage compartment has adjustable shelves that adjust in 1 1/4" increments.

Cabinet Ht.—Number of shelves (with box/file configuration)

57" high—2 shelves

68" high—3 shelves

Cabinet Ht.—Number of shelves (with box/box/file or file/file configuration)

57" high—1 shelf

68" high—2 shelves

Drawers have full-extension ball-bearing slides. File drawers in 16"-wide tower accommodate front-to-back filing of letter-size hanging files. File drawers in 30", 36"- and 42"-wide towers accommodate side-to-side and front-to-back filing of letter-, legal-, and A4-size hanging files.

Tower case is available in laminate or veneer; doors in laminate, veneer, or back-painted glass; 3/8" thin top in laminate or veneer.

Glass doors are back-painted and writable with dry-erase marker. Glass doors cannot lock.

Grain direction is vertical on veneer, wood-grain, and patterned laminate case and fronts.

Dimensional illustration does not include all possible configurations.

For keyed-alike locks, see Keyed-Alike Information in appendices.

Dimensions

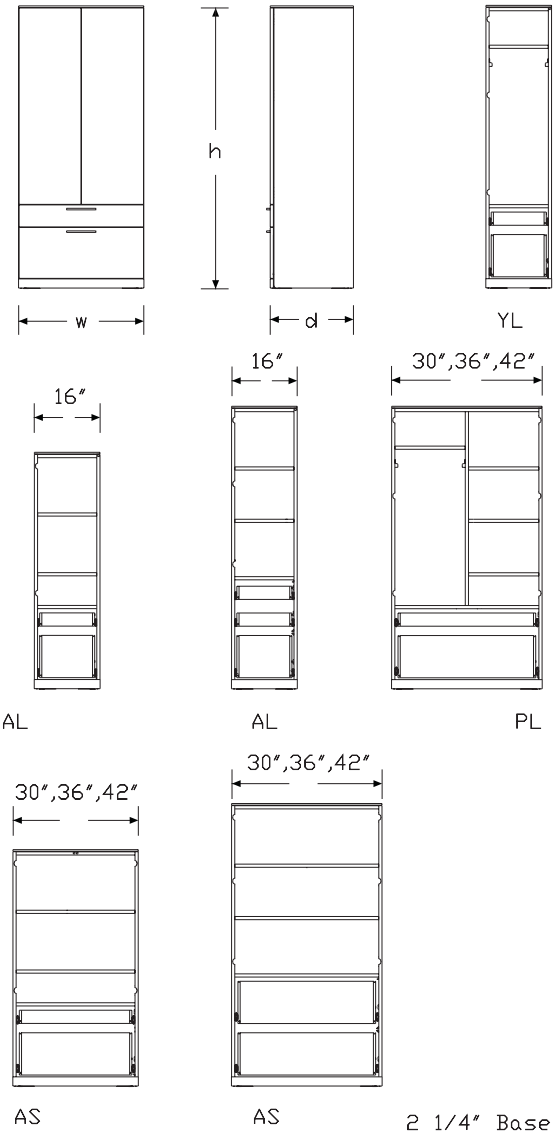

2 1/4" Base

Wood Vertical Tower with Lower Storage *continued*

Specification Information

Step 1.

FF53M. A

Step 2. File Configuration

BF	box/file low credenza A	+\$1000
BB	box/box/file high credenza A	+\$1500
FF	file/file high credenza A	+\$2000

Step 3. Height

6	57" high A	+\$800
7	68" high A	+\$900

Step 4. Width

For box/file low credenza (BF) or file/file high credenza (FF)

16	15 ⁵ / ₈ " wide A	+\$300
30	30" wide A	+\$500
36	36" wide A	+\$600
42	42" wide A	+\$700

For box/box/file high credenza (BB)

16	15 ⁵ / ₈ " wide A	+\$300
-----------	---	--------

Step 5. Depth

2	20" deep A	+\$250
4	24" deep A	+\$360

Step 6. Base/Foot Height

For box/file low credenza (BF)

2	2 ¹ / ₄ "-high base A	+\$100
4	4"-high foot A	+\$200

For box/box/file high credenza (BB) or file/file high credenza (FF)

2	2 ¹ / ₄ "-high base A	+\$100
----------	---	--------

Step 7. Configuration

For box/file low credenza (BF) with 57" high (6) with 15⁵/₈" wide (16) with 2¹/₄"-high base (2) or 4"-high foot (4)

AL	shelves, left-hinged door A	+\$120
AR	shelves, right-hinged door A	+\$120

For box/file low credenza (BF) with 68" high (7) with 15⁵/₈" wide (16) with 2¹/₄"-high base (2) or 4"-high foot (4)

YL	wardrobe only, left-hinged door A	+\$140
YR	wardrobe only, right-hinged door A	+\$140
AL	shelves, left-hinged door A	+\$160
AR	shelves, right-hinged door A	+\$160

For box/box/file high credenza (BB) or file/file high credenza (FF) with 57" high (6) or 68" high (7) with 15⁵/₈" wide (16) with 2¹/₄"-high base (2)

AL	shelves, left-hinged door A	+\$170
AR	shelves, right-hinged door A	+\$170

For box/file low credenza (BF) with 57" high (6) with 30" wide (30), 36" wide (36), or 42" wide (42) with 2¹/₄"-high base (2) or 4"-high foot (4)

AS	shelves, two symmetrical doors A	+\$250
-----------	--	--------

For box/file low credenza (BF) with 68" high (7) with 30" wide (30), 36" wide (36), or 42" wide (42) with 2¹/₄"-high base (2) or 4"-high foot (4)

YS	wardrobe only, two symmetrical doors A	+\$180
PL	wardrobe left, shelves right, two symmetrical doors A	+\$225
PR	shelves left, wardrobe right, two symmetrical doors A	+\$225
AS	shelves, two symmetrical doors A	+\$250

For file/file high credenza (FF) with 57" high (6) or 68" high (7) with 30" wide (30), 36" wide (36), or 42" wide (42) with 2¹/₄"-high base (2)

AS	shelves, two symmetrical doors A	+\$250
-----------	--	--------

Step 8. Case/Door Material

For 15⁵/₈" wide (16)

L	laminate case and doors A	+\$700
C	laminate case/veneer doors A	+\$1000
G	laminate case/glass doors A	+\$1625
W	veneer case and doors A	+\$2000
R	veneer case/glass doors A	+\$2925

For 30" wide (30)

L	laminate case and doors A	+\$800
C	laminate case/veneer doors A	+\$1150
G	laminate case/glass doors A	+\$2650
W	veneer case and doors A	+\$3350
R	veneer case/glass doors A	+\$4800

Wood Vertical Tower with Lower Storage *continued*

For 36" wide (36)		
L	laminate case and doors <input type="checkbox"/> A	+\$1000
C	laminate case/veneer doors <input type="checkbox"/> A	+\$1425
G	laminate case/glass doors <input type="checkbox"/> A	+\$3225
W	veneer case and doors <input type="checkbox"/> A	+\$3450
R	veneer case/glass doors <input type="checkbox"/> A	+\$4900

For 42" wide (42)		
L	laminate case and doors <input type="checkbox"/> A	+\$1200
C	laminate case/veneer doors <input type="checkbox"/> A	+\$2000
G	laminate case/glass doors <input type="checkbox"/> A	+\$3500
W	veneer case and doors <input type="checkbox"/> A	+\$3650
R	veneer case/glass doors <input type="checkbox"/> A	+\$5900

Step 9. Top		
T	finished case top <input type="checkbox"/> A	+\$0
3	$\frac{3}{8}$ " laminate thin top <input type="checkbox"/> A	+\$150
4	$\frac{3}{8}$ " veneer thin top <input type="checkbox"/> A	+\$300

Step 10. Drawer Body Material		
W	wood <input type="checkbox"/> A	+\$0

Step 11. Lock

For laminate case and doors (L), laminate case/veneer doors (C), or veneer case and doors (W)		
D	lock on doors and drawers <input type="checkbox"/> A	+\$0
L	lock on doors <input type="checkbox"/> A	+\$0
R	lock on drawers <input type="checkbox"/> A	+\$0
N	no lock <input type="checkbox"/> A	+\$0

For laminate case/glass doors (G) or veneer case/glass doors (R)		
R	lock on drawers <input type="checkbox"/> A	+\$0
N	no lock <input type="checkbox"/> A	+\$0

Step 12. Case/Edge Finish

For laminate case and doors (L), laminate case/veneer doors (C), or laminate case/glass doors (G)

76	light brown walnut <input type="checkbox"/> A	+\$0
8Q	folkstone grey <input type="checkbox"/> A	+\$0
91	white <input type="checkbox"/> A	+\$0
98	studio white <input type="checkbox"/> A	+\$0
CL	cool grey neutral <input type="checkbox"/> A	+\$0
HM	natural maple <input type="checkbox"/> A	+\$0
HP	light anigre <input type="checkbox"/> A	+\$0
HX	aged cherry <input type="checkbox"/> A	+\$0
HY	walnut on cherry <input type="checkbox"/> A	+\$0
LA	light ash <input type="checkbox"/> A	+\$0
LBA	clear on ash <input type="checkbox"/> A	+\$0
LBR	phantom ecru <input type="checkbox"/> A	+\$0
LBS	phantom cocoa <input type="checkbox"/> A	+\$0
LBU	medium matte walnut <input type="checkbox"/> A	+\$0
LBV	warm grey teak <input type="checkbox"/> A	+\$0
LBB	oak on ash <input type="checkbox"/> A	+\$0
LBC	walnut on ash <input type="checkbox"/> A	+\$0
LBD	dark brown walnut <input type="checkbox"/> A	+\$0
LBE	medium red walnut <input type="checkbox"/> A	+\$0
LBF	neutral twill <input type="checkbox"/> A	+\$0
LBG	sarum twill <input type="checkbox"/> A	+\$0
LBH	earthen twill <input type="checkbox"/> A	+\$0
LBJ	graphite twill <input type="checkbox"/> A	+\$0
LBK	pewter mesh <input type="checkbox"/> A	+\$0
LBL	steel mesh <input type="checkbox"/> A	+\$0
LBM	crisp linen <input type="checkbox"/> A	+\$0
LBN	classic linen <input type="checkbox"/> A	+\$0
LBP	casual linen <input type="checkbox"/> A	+\$0
LBQ	white twill <input type="checkbox"/> A	+\$0
LU	soft white <input type="checkbox"/> A	+\$0
WL	sandstone <input type="checkbox"/> A	+\$0
WN	warm grey neutral <input type="checkbox"/> A	+\$0

Wood Vertical Tower with Lower Storage *continued*

Wood Veneer

For veneer case and doors (W) or veneer case/glass doors (R)

2U	light brown walnut <input type="checkbox"/>	+\$0
40	dark brown walnut <input type="checkbox"/>	+\$0
ED	aged cherry <input type="checkbox"/>	+\$0
EK	medium red walnut <input type="checkbox"/>	+\$0
EW	medium matte walnut <input type="checkbox"/>	+\$0
ET	clear on ash <input type="checkbox"/>	+\$0
EU	oak on ash <input type="checkbox"/>	+\$0
EV	walnut on ash <input type="checkbox"/>	+\$0
UL	natural maple <input type="checkbox"/>	+\$0
UX	walnut on cherry <input type="checkbox"/>	+\$0

Step 13. Door/Edge Finish

For laminate case and doors (L)

76	light brown walnut <input type="checkbox"/>	+\$0
8Q	folkstone grey <input type="checkbox"/>	+\$0
91	white <input type="checkbox"/>	+\$0
98	studio white <input type="checkbox"/>	+\$0
CL	cool grey neutral <input type="checkbox"/>	+\$0
HM	natural maple <input type="checkbox"/>	+\$0
HP	light anigre <input type="checkbox"/>	+\$0
HX	aged cherry <input type="checkbox"/>	+\$0
HY	walnut on cherry <input type="checkbox"/>	+\$0
LA	light ash <input type="checkbox"/>	+\$0
LBA	clear on ash <input type="checkbox"/>	+\$0
LBR	phantom ecru <input type="checkbox"/>	+\$0
LBS	phantom cocoa <input type="checkbox"/>	+\$0
LBU	medium matte walnut <input type="checkbox"/>	+\$0
LBV	warm grey teak <input type="checkbox"/>	+\$0
LBW	oak on ash <input type="checkbox"/>	+\$0
LBC	walnut on ash <input type="checkbox"/>	+\$0
LBD	dark brown walnut <input type="checkbox"/>	+\$0
LBE	medium red walnut <input type="checkbox"/>	+\$0
LBF	neutral twill <input type="checkbox"/>	+\$0
LBG	sarum twill <input type="checkbox"/>	+\$0
LBH	earthen twill <input type="checkbox"/>	+\$0
LBJ	graphite twill <input type="checkbox"/>	+\$0
LBK	pewter mesh <input type="checkbox"/>	+\$0
LBL	steel mesh <input type="checkbox"/>	+\$0
LBM	crisp linen <input type="checkbox"/>	+\$0
LBN	classic linen <input type="checkbox"/>	+\$0
LBP	casual linen <input type="checkbox"/>	+\$0
LBQ	white twill <input type="checkbox"/>	+\$0
LU	soft white <input type="checkbox"/>	+\$0
WL	sandstone <input type="checkbox"/>	+\$0
WN	warm grey neutral <input type="checkbox"/>	+\$0

Wood Vertical Tower with Lower Storage *continued*

Wood Veneer

For laminate case/veneer doors (C) or veneer case and doors (W)

2U	light brown walnut <input type="checkbox"/>	+\$0
40	dark brown walnut <input type="checkbox"/>	+\$0
ED	aged cherry <input type="checkbox"/>	+\$0
EK	medium red walnut <input type="checkbox"/>	+\$0
EW	medium matte walnut <input type="checkbox"/>	+\$0
ET	clear on ash <input type="checkbox"/>	+\$0
EU	oak on ash <input type="checkbox"/>	+\$0
EV	walnut on ash <input type="checkbox"/>	+\$0
UL	natural maple <input type="checkbox"/>	+\$0
UX	walnut on cherry <input type="checkbox"/>	+\$0

Glass

For laminate case/glass doors (G) or veneer case/glass doors (R)

8Q	folkstone grey <input type="checkbox"/>	+\$0
91	white <input type="checkbox"/>	+\$0
98	studio white <input type="checkbox"/>	+\$0

Step 14. Top/Edge Finish

For 3/8" laminate thin top (3)

76	light brown walnut <input type="checkbox"/>	+\$0
8Q	folkstone grey <input type="checkbox"/>	+\$0
91	white <input type="checkbox"/>	+\$0
98	studio white <input type="checkbox"/>	+\$0
CL	cool grey neutral <input type="checkbox"/>	+\$0
HM	natural maple <input type="checkbox"/>	+\$0
HP	light anigre <input type="checkbox"/>	+\$0
HX	aged cherry <input type="checkbox"/>	+\$0
HY	walnut on cherry <input type="checkbox"/>	+\$0
LA	light ash <input type="checkbox"/>	+\$0
LBA	clear on ash <input type="checkbox"/>	+\$0
LBR	phantom ecru <input type="checkbox"/>	+\$0
LBS	phantom cocoa <input type="checkbox"/>	+\$0
LBU	medium matte walnut <input type="checkbox"/>	+\$0
LBV	warm grey teak <input type="checkbox"/>	+\$0
LBB	oak on ash <input type="checkbox"/>	+\$0
LBC	walnut on ash <input type="checkbox"/>	+\$0
LBD	dark brown walnut <input type="checkbox"/>	+\$0
LBE	medium red walnut <input type="checkbox"/>	+\$0
LBF	neutral twill <input type="checkbox"/>	+\$0
LBG	sarum twill <input type="checkbox"/>	+\$0
LBH	earthen twill <input type="checkbox"/>	+\$0
LBJ	graphite twill <input type="checkbox"/>	+\$0
LBK	pewter mesh <input type="checkbox"/>	+\$0
LBL	steel mesh <input type="checkbox"/>	+\$0
LBM	crisp linen <input type="checkbox"/>	+\$0
LBN	classic linen <input type="checkbox"/>	+\$0
LBP	casual linen <input type="checkbox"/>	+\$0
LBQ	white twill <input type="checkbox"/>	+\$0
LU	soft white <input type="checkbox"/>	+\$0
WL	sandstone <input type="checkbox"/>	+\$0
WN	warm grey neutral <input type="checkbox"/>	+\$0

Wood Vertical Tower with Lower Storage *continued*

Wood Veneer

For $\frac{3}{8}$ " veneer thin top (4)

2U	light brown walnut <input type="checkbox"/>	+\$0
40	dark brown walnut <input type="checkbox"/>	+\$0
ED	aged cherry <input type="checkbox"/>	+\$0
EK	medium red walnut <input type="checkbox"/>	+\$0
EW	medium matte walnut <input type="checkbox"/>	+\$0
ET	clear on ash <input type="checkbox"/>	+\$0
EU	oak on ash <input type="checkbox"/>	+\$0
EV	walnut on ash <input type="checkbox"/>	+\$0
UL	natural maple <input type="checkbox"/>	+\$0
UX	walnut on cherry <input type="checkbox"/>	+\$0

Step 15. Foot Finish

For 4"-high foot (4)

Bright Sand Texture Paint

91	white <input type="checkbox"/>	+\$0
CL	cool grey neutral <input type="checkbox"/>	+\$0
G1	graphite <input type="checkbox"/>	+\$0
WN	warm grey neutral <input type="checkbox"/>	+\$0

Metallic Paint

CN	metallic champagne <input type="checkbox"/>	+\$0
EH	metallic bronze <input type="checkbox"/>	+\$0
MS	metallic silver <input type="checkbox"/>	+\$0

Step 16. Drawer Pull Finish

79	green apple <input type="checkbox"/>	+\$15
8Q	folkstone grey <input type="checkbox"/>	+\$0
91	white <input type="checkbox"/>	+\$0
98	studio white <input type="checkbox"/>	+\$0
CN	metallic champagne <input type="checkbox"/>	+\$0
G1	graphite <input type="checkbox"/>	+\$0
MS	metallic silver <input type="checkbox"/>	+\$0
MY3	yellow oxide <input type="checkbox"/>	+\$15
RO	red <input type="checkbox"/>	+\$15
TRQ	turquoise <input type="checkbox"/>	+\$15
WL	sandstone <input type="checkbox"/>	+\$0

Step 17. Lock Option

For lock on doors and drawers (D), lock on drawers (R), or lock on doors (L)

KA	keyed alike <input type="checkbox"/>	-\$10
KC	keyed differently, chrome <input type="checkbox"/>	+\$0
KD	keyed differently, black <input type="checkbox"/>	+\$0

Canvas Cabinet/Wall Attachment Bracket FV692.

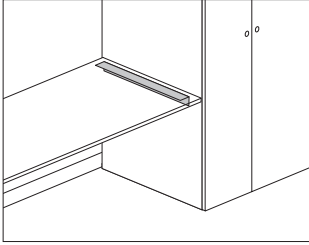

Product Information

Description
 This bracket attaches 1 end of a surface to a Canvas wood vertical storage cabinet or architectural wall, eliminating the need for a support leg. Finish is black. Attachment hardware included.

Notes

Supports a 20" or 24" deep surface.
 20" deep surface can be attached to a 20" or 24" deep wood vertical storage cabinet or architectural wall.
 24" deep surface can be attached to a 24" deep wood vertical storage cabinet or architectural wall.

Dimensions

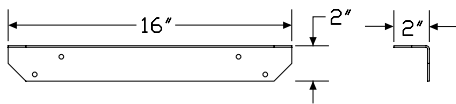

Specification Information

Step 1.
FV692. \$66

Wood Freestanding Bookcase

FF54M.

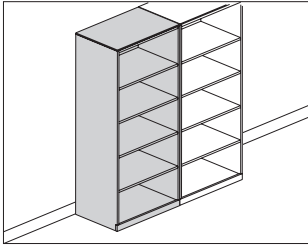

Product Information

Description

This freestanding bookcase tower provides open or enclosed shelf storage. It is available with a 2 1/4"-high base or 4"-high architectural feet with 1" leveling glides. Top options are a finished case top or 3/8" laminate or veneer thin top. 12", 15", and 24"-wide towers have a single door; 30", 36"- and 42"-wide towers have 2 symmetrical doors. Tower doors have touch latches and optional locks.

Notes

- Tower with finished case top aligns with top of bead on a frame attached tile. Adding a thin top increases overall tower height 1/2".
- Align like components next to like units: Finished case units with other finished case units, thin top units with other thin top units, 2 1/4" base storage units with other 2 1/4" base storage, and 4" foot storage with other 4" foot storage.
- Tower matches style of wood overhead storage cabinet, open (FV43C.) or overhead storage cabinet, hinged doors (FV43H.).
- Actual tower widths are 11 7/8" (12), 14 7/8" (15), 23 7/8" (24), 29 7/8" (30), 35 7/8" (36), or 41 7/8" (42); actual depths are 14 7/8" (1), 19 7/8" (2), or 23 7/8" (4).
- 20" deep (2) matches Canvas low storage depth.
- 24" deep (4) matches Canvas rectangular work surface at 24" deep, no gap.
- Shelves adjust in 1 1/4" increments.
- Cabinet Ht. — Number of shelves
- 42" high—2 shelves
- 46" high—2 shelves
- 53" high—3 shelves
- 57" high—3 shelves
- 68" high—4 shelves
- Tower case is available in laminate or veneer; doors in laminate, veneer, or back-painted glass; 3/8" thin top in laminate or veneer.
- Glass doors are back-painted and writable with dry-erase marker. Glass doors cannot lock.
- Grain direction is vertical on veneer, wood-grain, and patterned laminate case and fronts.
- Dimensional illustration does not include all possible configurations.
- For keyed-alike locks, see Keyed-Alike Information in appendices.

Dimensions

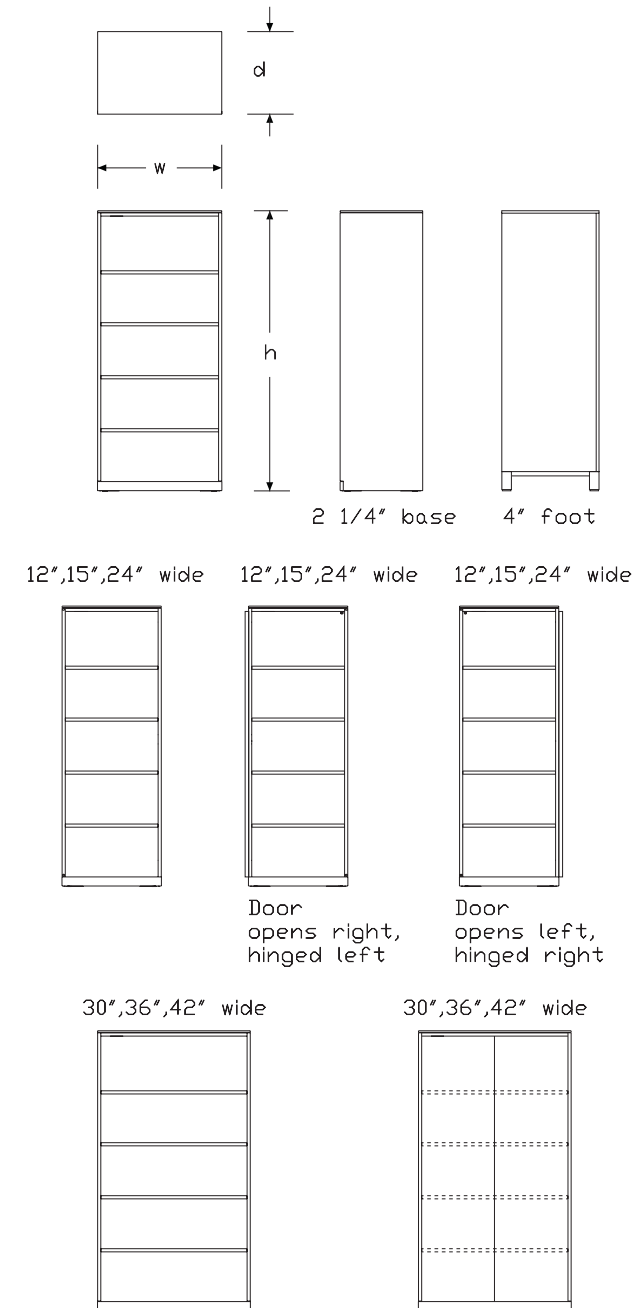

Wood Freestanding Bookcase

continued

Canvas Office Landscape® Wood Case Cabinets and Bookcases

Specification Information

Step 1.

FF54M. A

Step 2. Height

3	42" high A	+\$500
4	46" high A	+\$600
5	53" high A	+\$700
6	57" high A	+\$800
7	68" high A	+\$1000

Step 3. Width

12	12" wide A	+\$285
15	15" wide A	+\$335
24	24" wide A	+\$485
30	30" wide A	+\$540
36	36" wide A	+\$640
42	42" wide A	+\$850

Step 4. Depth

1	15" deep A	+\$200
2	20" deep A	+\$280
4	24" deep A	+\$360

Step 5. Base/Foot Height

2	2 1/4"-high base A	+\$100
4	4"-high foot A	+\$200

Step 6. Configuration

For 12" wide (12), 15" wide (15), or 24" wide (24)

ND	open bookcase A	+\$0
BL	bookcase with left-hinged door A	+\$250
BR	bookcase with right-hinged door A	+\$250

For 30" wide (30), 36" wide (36), or 42" wide (42)

ND	open bookcase A	+\$0
BD	bookcase with two symmetrical doors A	+\$325

Step 7. Case Material

For 42" high (3), 46" high (4), or 53" high (5) with 12" wide (12) or 15" wide (15)

L	laminated A	+\$0
W	veneer A	+\$332

For 42" high (3), 46" high (4), or 53" high (5) with 24" wide (24)

L	laminated A	+\$0
W	veneer A	+\$782

For 42" high (3), 46" high (4), or 53" high (5) with 30" wide (30)

L	laminated A	+\$0
W	veneer A	+\$932

For 42" high (3), 46" high (4), or 53" high (5) with 36" wide (36)

L	laminated A	+\$0
W	veneer A	+\$1082

For 42" high (3), 46" high (4), or 53" high (5) with 42" wide (42)

L	laminated A	+\$0
W	veneer A	+\$1232

For 57" high (6) or 68" high (7) with 12" wide (12) or 15" wide (15)

L	laminated A	+\$150
W	veneer A	+\$682

For 57" high (6) or 68" high (7) with 24" wide (24)

L	laminated A	+\$150
W	veneer A	+\$1125

For 57" high (6) or 68" high (7) with 30" wide (30)

L	laminated A	+\$150
W	veneer A	+\$1432

For 57" high (6) or 68" high (7) with 36" wide (36)

L	laminated A	+\$150
W	veneer A	+\$1757

For 57" high (6) or 68" high (7) with 42" wide (42)

L	laminated A	+\$150
W	veneer A	+\$2082

Step 8. Door Material

For 42" high (3), 46" high (4), or 53" high (5) with 12" wide (12) or 15" wide (15) with bookcase with left-hinged door (BL) or bookcase with right-hinged door (BR)

L	laminated A	+\$450
W	veneer A	+\$968
G	glass A	+\$940

Wood Freestanding Bookcase

continued

For 42" high (3), 46" high (4), or 53" high (5) with 24" wide (24) with bookcase with left-hinged door (BL) or bookcase with right-hinged door (BR)

L	laminate A	+\$884
W	veneer A	+\$1800
G	glass A	+\$1800

For 42" high (3), 46" high (4), or 53" high (5) with 30" wide (30) with bookcase with two symmetrical doors (BD)

L	laminate A	+\$1134
W	veneer A	+\$2068
G	glass A	+\$2100

For 42" high (3), 46" high (4), or 53" high (5) with 36" wide (36) with bookcase with two symmetrical doors (BD)

L	laminate A	+\$1384
W	veneer A	+\$2568
G	glass A	+\$2600

For 42" high (3), 46" high (4), or 53" high (5) with 42" wide (42) with bookcase with two symmetrical doors (BD)

L	laminate A	+\$1484
W	veneer A	+\$3068
G	glass A	+\$3100

For 57" high (6) or 68" high (7) with 12" wide (12) or 15" wide (15) with bookcase with left-hinged door (BL) or bookcase with right-hinged door (BR)

L	laminate A	+\$468
W	veneer A	+\$1218
G	glass A	+\$1200

For 57" high (6) or 68" high (7) with 24" wide (24) with bookcase with left-hinged door (BL) or bookcase with right-hinged door (BR)

L	laminate A	+\$768
W	veneer A	+\$2300
G	glass A	+\$2400

For 57" high (6) or 68" high (7) with 30" wide (30) with bookcase with two symmetrical doors (BD)

L	laminate A	+\$1068
W	veneer A	+\$2868
G	glass A	+\$2900

For 57" high (6) or 68" high (7) with 36" wide (36) with bookcase with two symmetrical doors (BD)

L	laminate A	+\$1368
W	veneer A	+\$3368
G	glass A	+\$3800

For 57" high (6) or 68" high (7) with 42" wide (42) with bookcase with two symmetrical doors (BD)

L	laminate A	+\$1668
W	veneer A	+\$4268
G	glass A	+\$4300

Step 9. Base Material

L	laminate A	+\$100
W	veneer A	+\$150

Step 10. Top Material

T	finished case top A	+\$0
3	3/8" laminate thin top A	+\$150
4	3/8" veneer thin top A	+\$300

Step 11. Lock

For laminate (L) or veneer (W)

N	no lock A	+\$0
L	lock A	+\$0

For glass (G)

N	no lock A	+\$0
----------	------------------	------

Wood Freestanding Bookcase

continued

Step 12. Case/Edge Finish

For laminate (L)

76	light brown walnut <input type="checkbox"/>	+\$0
8Q	folkstone grey <input type="checkbox"/>	+\$0
91	white <input type="checkbox"/>	+\$0
98	studio white <input type="checkbox"/>	+\$0
CL	cool grey neutral <input type="checkbox"/>	+\$0
HM	natural maple <input type="checkbox"/>	+\$0
HP	light anigre <input type="checkbox"/>	+\$0
HX	aged cherry <input type="checkbox"/>	+\$0
HY	walnut on cherry <input type="checkbox"/>	+\$0
LA	light ash <input type="checkbox"/>	+\$0
LBA	clear on ash <input type="checkbox"/>	+\$0
LBR	phantom ecru <input type="checkbox"/>	+\$0
LBS	phantom cocoa <input type="checkbox"/>	+\$0
LBU	medium matte walnut <input type="checkbox"/>	+\$0
LBV	warm grey teak <input type="checkbox"/>	+\$0
LBB	oak on ash <input type="checkbox"/>	+\$0
LBC	walnut on ash <input type="checkbox"/>	+\$0
LBD	dark brown walnut <input type="checkbox"/>	+\$0
LBE	medium red walnut <input type="checkbox"/>	+\$0
LBF	neutral twill <input type="checkbox"/>	+\$0
LBG	sarum twill <input type="checkbox"/>	+\$0
LBH	earthen twill <input type="checkbox"/>	+\$0
LBJ	graphite twill <input type="checkbox"/>	+\$0
LBK	pewter mesh <input type="checkbox"/>	+\$0
LBL	steel mesh <input type="checkbox"/>	+\$0
LBM	crisp linen <input type="checkbox"/>	+\$0
LBN	classic linen <input type="checkbox"/>	+\$0
LBP	casual linen <input type="checkbox"/>	+\$0
LBQ	white twill <input type="checkbox"/>	+\$0
LU	soft white <input type="checkbox"/>	+\$0
WL	sandstone <input type="checkbox"/>	+\$0
WN	warm grey neutral <input type="checkbox"/>	+\$0

For veneer (W)

2U	light brown walnut <input type="checkbox"/>	+\$0
40	dark brown walnut <input type="checkbox"/>	+\$0
ED	aged cherry <input type="checkbox"/>	+\$0
EK	medium red walnut <input type="checkbox"/>	+\$0
EW	medium matte walnut <input type="checkbox"/>	+\$0
ET	clear on ash <input type="checkbox"/>	+\$0
EU	oak on ash <input type="checkbox"/>	+\$0
EV	walnut on ash <input type="checkbox"/>	+\$0
UL	natural maple <input type="checkbox"/>	+\$0
UX	walnut on cherry <input type="checkbox"/>	+\$0

Step 13. Door/Edge Finish

For laminate (L)

76	light brown walnut <input type="checkbox"/>	+\$0
8Q	folkstone grey <input type="checkbox"/>	+\$0
91	white <input type="checkbox"/>	+\$0
98	studio white <input type="checkbox"/>	+\$0
CL	cool grey neutral <input type="checkbox"/>	+\$0
HM	natural maple <input type="checkbox"/>	+\$0
HP	light anigre <input type="checkbox"/>	+\$0
HX	aged cherry <input type="checkbox"/>	+\$0
HY	walnut on cherry <input type="checkbox"/>	+\$0
LA	light ash <input type="checkbox"/>	+\$0
LBA	clear on ash <input type="checkbox"/>	+\$0
LBR	phantom ecru <input type="checkbox"/>	+\$0
LBS	phantom cocoa <input type="checkbox"/>	+\$0
LBU	medium matte walnut <input type="checkbox"/>	+\$0
LBV	warm grey teak <input type="checkbox"/>	+\$0
LBB	oak on ash <input type="checkbox"/>	+\$0
LBC	walnut on ash <input type="checkbox"/>	+\$0
LBD	dark brown walnut <input type="checkbox"/>	+\$0
LBE	medium red walnut <input type="checkbox"/>	+\$0
LBF	neutral twill <input type="checkbox"/>	+\$0
LBG	sarum twill <input type="checkbox"/>	+\$0
LBH	earthen twill <input type="checkbox"/>	+\$0
LBJ	graphite twill <input type="checkbox"/>	+\$0
LBK	pewter mesh <input type="checkbox"/>	+\$0
LBL	steel mesh <input type="checkbox"/>	+\$0
LBM	crisp linen <input type="checkbox"/>	+\$0
LBN	classic linen <input type="checkbox"/>	+\$0
LBP	casual linen <input type="checkbox"/>	+\$0
LBQ	white twill <input type="checkbox"/>	+\$0
LU	soft white <input type="checkbox"/>	+\$0
WL	sandstone <input type="checkbox"/>	+\$0
WN	warm grey neutral <input type="checkbox"/>	+\$0

For veneer (W)

2U	light brown walnut <input type="checkbox"/>	+\$0
40	dark brown walnut <input type="checkbox"/>	+\$0
ED	aged cherry <input type="checkbox"/>	+\$0
EK	medium red walnut <input type="checkbox"/>	+\$0
EW	medium matte walnut <input type="checkbox"/>	+\$0
ET	clear on ash <input type="checkbox"/>	+\$0
EU	oak on ash <input type="checkbox"/>	+\$0
EV	walnut on ash <input type="checkbox"/>	+\$0
UL	natural maple <input type="checkbox"/>	+\$0
UX	walnut on cherry <input type="checkbox"/>	+\$0

Wood Freestanding Bookcase

continued

For glass (G)

8Q	folkstone grey <input type="checkbox"/>	+\$0
91	white <input type="checkbox"/>	+\$0
98	studio white <input type="checkbox"/>	+\$0

Step 14. Top/Edge Finish

For 3/8" laminate thin top (3)

76	light brown walnut <input type="checkbox"/>	+\$0
8Q	folkstone grey <input type="checkbox"/>	+\$0
91	white <input type="checkbox"/>	+\$0
98	studio white <input type="checkbox"/>	+\$0
CL	cool grey neutral <input type="checkbox"/>	+\$0
HM	natural maple <input type="checkbox"/>	+\$0
HP	light anigre <input type="checkbox"/>	+\$0
HX	aged cherry <input type="checkbox"/>	+\$0
HY	walnut on cherry <input type="checkbox"/>	+\$0
LA	light ash <input type="checkbox"/>	+\$0
LBA	clear on ash <input type="checkbox"/>	+\$0
LBR	phantom ecru <input type="checkbox"/>	+\$0
LBS	phantom cocoa <input type="checkbox"/>	+\$0
LBU	medium matte walnut <input type="checkbox"/>	+\$0
LBV	warm grey teak <input type="checkbox"/>	+\$0
LBB	oak on ash <input type="checkbox"/>	+\$0
LBC	walnut on ash <input type="checkbox"/>	+\$0
LBD	dark brown walnut <input type="checkbox"/>	+\$0
LBE	medium red walnut <input type="checkbox"/>	+\$0
LBF	neutral twill <input type="checkbox"/>	+\$0
LBG	sarum twill <input type="checkbox"/>	+\$0
LBH	earthen twill <input type="checkbox"/>	+\$0
LBJ	graphite twill <input type="checkbox"/>	+\$0
LBK	pewter mesh <input type="checkbox"/>	+\$0
LBL	steel mesh <input type="checkbox"/>	+\$0
LBM	crisp linen <input type="checkbox"/>	+\$0
LBN	classic linen <input type="checkbox"/>	+\$0
LBP	casual linen <input type="checkbox"/>	+\$0
LBQ	white twill <input type="checkbox"/>	+\$0
LU	soft white <input type="checkbox"/>	+\$0
WL	sandstone <input type="checkbox"/>	+\$0
WN	warm grey neutral <input type="checkbox"/>	+\$0

For 3/8" veneer thin top (4)

2U	light brown walnut <input type="checkbox"/>	+\$0
40	dark brown walnut <input type="checkbox"/>	+\$0
ED	aged cherry <input type="checkbox"/>	+\$0
EK	medium red walnut <input type="checkbox"/>	+\$0
EW	medium matte walnut <input type="checkbox"/>	+\$0
ET	clear on ash <input type="checkbox"/>	+\$0
EU	oak on ash <input type="checkbox"/>	+\$0
EV	walnut on ash <input type="checkbox"/>	+\$0
UL	natural maple <input type="checkbox"/>	+\$0
UX	walnut on cherry <input type="checkbox"/>	+\$0

Step 15. Base/Foot Finish

For 4"-high foot (4)

91	white <input type="checkbox"/>	+\$0
CL	cool grey neutral <input type="checkbox"/>	+\$0
G1	graphite <input type="checkbox"/>	+\$0
WN	warm grey neutral <input type="checkbox"/>	+\$0

For 4"-high foot (4)

CN	metallic champagne <input type="checkbox"/>	+\$0
EH	metallic bronze <input type="checkbox"/>	+\$0
MS	metallic silver <input type="checkbox"/>	+\$0

Wood Freestanding Bookcase

continued

For 2¹/₄"-high base (2) with laminate (L)

76	light brown walnut <input type="checkbox"/> A	+\$0
8Q	folkstone grey <input type="checkbox"/> A	+\$0
91	white <input type="checkbox"/> A	+\$0
98	studio white <input type="checkbox"/> A	+\$0
CL	cool grey neutral <input type="checkbox"/> A	+\$0
HM	natural maple <input type="checkbox"/> A	+\$0
HP	light anigre <input type="checkbox"/> A	+\$0
HX	aged cherry <input type="checkbox"/> A	+\$0
HY	walnut on cherry <input type="checkbox"/> A	+\$0
LA	light ash <input type="checkbox"/> A	+\$0
LBA	clear on ash <input type="checkbox"/> A	+\$0
LBR	phantom ecru <input type="checkbox"/> A	+\$0
LBS	phantom cocoa <input type="checkbox"/> A	+\$0
LBU	medium matte walnut <input type="checkbox"/> A	+\$0
LBV	warm grey teak <input type="checkbox"/> A	+\$0
LBB	oak on ash <input type="checkbox"/> A	+\$0
LBC	walnut on ash <input type="checkbox"/> A	+\$0
LBD	dark brown walnut <input type="checkbox"/> A	+\$0
LBE	medium red walnut <input type="checkbox"/> A	+\$0
LBF	neutral twill <input type="checkbox"/> A	+\$0
LBG	sarum twill <input type="checkbox"/> A	+\$0
LBH	earthen twill <input type="checkbox"/> A	+\$0
LBJ	graphite twill <input type="checkbox"/> A	+\$0
LBK	pewter mesh <input type="checkbox"/> A	+\$0
LBL	steel mesh <input type="checkbox"/> A	+\$0
LBM	crisp linen <input type="checkbox"/> A	+\$0
LBN	classic linen <input type="checkbox"/> A	+\$0
LBP	casual linen <input type="checkbox"/> A	+\$0
LBQ	white twill <input type="checkbox"/> A	+\$0
LU	soft white <input type="checkbox"/> A	+\$0
WL	sandstone <input type="checkbox"/> A	+\$0
WN	warm grey neutral <input type="checkbox"/> A	+\$0

For 2¹/₄"-high base (2) with veneer (W)

2U	light brown walnut <input type="checkbox"/> A	+\$0
40	dark brown walnut <input type="checkbox"/> A	+\$0
ED	aged cherry <input type="checkbox"/> A	+\$0
EK	medium red walnut <input type="checkbox"/> A	+\$0
EW	medium matte walnut <input type="checkbox"/> A	+\$0
ET	clear on ash <input type="checkbox"/> A	+\$0
EU	oak on ash <input type="checkbox"/> A	+\$0
EV	walnut on ash <input type="checkbox"/> A	+\$0
UL	natural maple <input type="checkbox"/> A	+\$0
UX	walnut on cherry <input type="checkbox"/> A	+\$0

Step 16. Lock Option

For lock (L)

KA	keyed alike <input type="checkbox"/> A	-\$10
KC	keyed differently, chrome <input type="checkbox"/> A	+\$0
KD	keyed differently, black <input type="checkbox"/> A	+\$0

Wood Wardrobe Tower

FF55M.

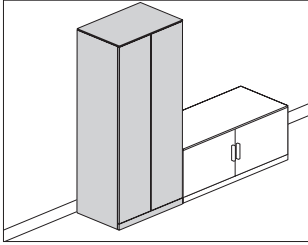

Product Information

Description

This freestanding wardrobe tower is available with a 2 1/4"-high base or 4"-high architectural feet with 1" leveling glides. Top options are a finished case top or 3/8" laminate or veneer thin top. Towers 12"-wide to 24"-wide have a single door, and 30"-wide or 36"-wide towers have 2 symmetrical doors. Tower doors have touch latches and optional locks.

Notes

Enclosed wardrobe tower with finished case top aligns with top of bead on a frame attached tile. Adding a thin top increases overall tower height 1/2".

Align like components next to like units: Finished case units with other finished case units, thin top units with other thin top units, 2 1/4" base storage units with other 2 1/4" base storage, and 4" foot storage with other 4" foot storage.

Tower matches style of wood overhead storage in FV43 series.

Actual tower widths are 11 7/8" (12), 14 7/8" (15), 23 7/8" (24), 29 7/8" (30), or 35 7/8" (36); actual depths are 19 7/8" (2), or 23 7/8" (4).

- 20" deep (2) matches Canvas low storage depth.
- 24" deep (4) matches Canvas work surface at 24" deep.

Wardrobe has an option for a low or high fixed-height shelf with coat hook or coat rod in units 53" high or higher.

- High fixed-height shelf will be 8 3/16" from the top of the unit on plinth base or 4" foot.
- Low fixed-height shelf will be 11 1/2" from bottom of the unit on plinth base and 11 7/16" from bottom of the unit on 4" foot.

Wardrobe units can be specified with a coat rod or coat hook. 12"-wide (12), 15"-wide (15), and 24"-wide (24) units have 1 coat hook; 30"-wide (30) and 36"-wide units have 2 coat hooks.

Wardrobe tower case is available in laminate or veneer; doors in laminate, veneer, or back-painted glass; 3/8" thin top in laminate or veneer.

Glass doors are back-painted and writable with dry-erase marker. Glass doors cannot lock.

Grain direction is vertical on veneer, wood-grain, and patterned laminate case and fronts.

Dimensional illustration does not include all possible configurations.

For keyed-alike locks, see Keyed-Alike Information in appendices.

Dimensions

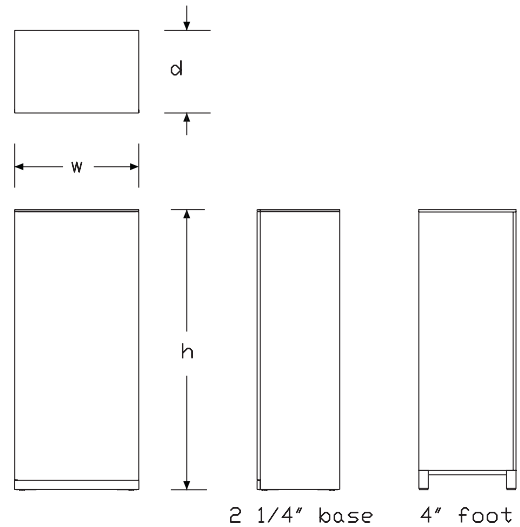

12", 15", 24" wide



YL, YR

30", 36" wide

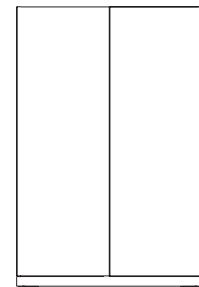

YS

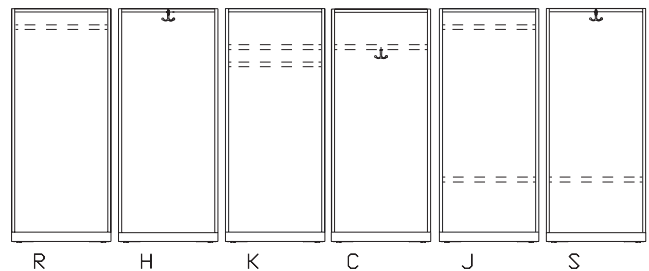

Single door wardrobe interior options

Specification Information			
Step 1.			
FF55M. <input type="checkbox"/> A			
Step 2. Height			
3	42" high	<input type="checkbox"/> A	+\$600
4	46" high	<input type="checkbox"/> A	+\$675
5	53" high	<input type="checkbox"/> A	+\$750
6	57" high	<input type="checkbox"/> A	+\$800
7	68" high	<input type="checkbox"/> A	+\$900
Step 3. Width			
<i>For 42" high (3) or 46" high (4)</i>			
12	12" wide	<input type="checkbox"/> A	+\$250
15	15" wide	<input type="checkbox"/> A	+\$300
24	24" wide	<input type="checkbox"/> A	+\$400
30	30" wide	<input type="checkbox"/> A	+\$500
36	36" wide	<input type="checkbox"/> A	+\$600
<i>For 53" high (5), 57" high (6), or 68" high (7)</i>			
15	15" wide	<input type="checkbox"/> A	+\$300
24	24" wide	<input type="checkbox"/> A	+\$400
30	30" wide	<input type="checkbox"/> A	+\$500
36	36" wide	<input type="checkbox"/> A	+\$600
Step 4. Depth			
2	20" deep	<input type="checkbox"/> A	+\$250
4	24" deep	<input type="checkbox"/> A	+\$360
Step 5. Base/Foot Height			
2	2 1/4"-high base	<input type="checkbox"/> A	+\$100
4	4"-high foot	<input type="checkbox"/> A	+\$200
Step 6. Configuration			
<i>For 12" wide (12), 15" wide (15), or 24" wide (24)</i>			
YL	wardrobe only, left-hinged door	<input type="checkbox"/> A	+\$0
YR	wardrobe only, right-hinged door	<input type="checkbox"/> A	+\$0
<i>For 30" wide (30) or 36" wide (36)</i>			
YS	wardrobe only, two symmetrical doors	<input type="checkbox"/> A	+\$0

Step 7. Wardrobe Interior			
<i>For 42" high (3) or 46" high (4)</i>			
R	coat rod only, full width	<input type="checkbox"/> A	+\$100
H	coat hook only, top attachment	<input type="checkbox"/> A	+\$0
<i>For 53" high (5), 57" high (6), or 68" high (7)</i>			
K	coat hook under high fixed shelf	<input type="checkbox"/> A	+\$100
C	coat rod under high fixed shelf	<input type="checkbox"/> A	+\$200
R	coat rod only, full width	<input type="checkbox"/> A	+\$100
H	coat hook only, top attachment	<input type="checkbox"/> A	+\$0
S	coat hook with low fixed height shelf	<input type="checkbox"/> A	+\$100
J	coat rod with low fixed height shelf	<input type="checkbox"/> A	+\$200
Step 8. Case/Door Material			
<i>For 42" high (3), 46" high (4), or 53" high (5) with 12" wide (12) or 15" wide (15)</i>			
L	laminated case and doors	<input type="checkbox"/> A	+\$422
C	laminated case/veneer doors	<input type="checkbox"/> A	+\$996
W	veneer case and doors	<input type="checkbox"/> A	+\$1327
G	laminated case/glass doors	<input type="checkbox"/> A	+\$940
R	veneer case/glass doors	<input type="checkbox"/> A	+\$1271
<i>For 42" high (3), 46" high (4), or 53" high (5) with 24" wide (24)</i>			
L	laminated case and doors	<input type="checkbox"/> A	+\$756
C	laminated case/veneer doors	<input type="checkbox"/> A	+\$1636
W	veneer case and doors	<input type="checkbox"/> A	+\$2314
G	laminated case/glass doors	<input type="checkbox"/> A	+\$1800
R	veneer case/glass doors	<input type="checkbox"/> A	+\$2478
<i>For 42" high (3), 46" high (4), or 53" high (5) with 30" wide (30)</i>			
L	laminated case and doors	<input type="checkbox"/> A	+\$949
C	laminated case/veneer doors	<input type="checkbox"/> A	+\$1793
W	veneer case and doors	<input type="checkbox"/> A	+\$2586
G	laminated case/glass doors	<input type="checkbox"/> A	+\$2100
R	veneer case/glass doors	<input type="checkbox"/> A	+\$2893
<i>For 42" high (3), 46" high (4), or 53" high (5) with 36" wide (36)</i>			
L	laminated case and doors	<input type="checkbox"/> A	+\$1141
C	laminated case/veneer doors	<input type="checkbox"/> A	+\$2178
W	veneer case and doors	<input type="checkbox"/> A	+\$3012
G	laminated case/glass doors	<input type="checkbox"/> A	+\$2600
R	veneer case/glass doors	<input type="checkbox"/> A	+\$3434

Wood Wardrobe Tower *continued*

For 57" high (6) or 68" high (7) with 15" wide (15)

L	laminate case and doors <input type="checkbox"/>	+\$552
C	laminate case/veneer doors <input type="checkbox"/>	+\$1304
W	veneer case and doors <input type="checkbox"/>	+\$1714
G	laminate case/glass doors <input type="checkbox"/>	+\$1316
R	veneer case/glass doors <input type="checkbox"/>	+\$1726

For 57" high (6) or 68" high (7) with 24" wide (24)

L	laminate case and doors <input type="checkbox"/>	+\$783
C	laminate case/veneer doors <input type="checkbox"/>	+\$2137
W	veneer case and doors <input type="checkbox"/>	+\$2888
G	laminate case/glass doors <input type="checkbox"/>	+\$2516
R	veneer case/glass doors <input type="checkbox"/>	+\$3267

For 57" high (6) or 68" high (7) with 30" wide (30)

L	laminate case and doors <input type="checkbox"/>	+\$1014
C	laminate case/veneer doors <input type="checkbox"/>	+\$2525
W	veneer case and doors <input type="checkbox"/>	+\$3512
G	laminate case/glass doors <input type="checkbox"/>	+\$3016
R	veneer case/glass doors <input type="checkbox"/>	+\$4003

For 57" high (6) or 68" high (7) with 36" wide (36)

L	laminate case and doors <input type="checkbox"/>	+\$1245
C	laminate case/veneer doors <input type="checkbox"/>	+\$2910
W	veneer case and doors <input type="checkbox"/>	+\$4147
G	laminate case/glass doors <input type="checkbox"/>	+\$3916
R	veneer case/glass doors <input type="checkbox"/>	+\$5153

Step 9. Base Material

L	laminate <input type="checkbox"/>	+\$100
W	veneer <input type="checkbox"/>	+\$150

Step 10. Top

T	finished case top <input type="checkbox"/>	+\$0
3	3/8" laminate thin top <input type="checkbox"/>	+\$150
4	3/8" veneer thin top <input type="checkbox"/>	+\$300

Step 11. Lock

L	lock <input type="checkbox"/>	+\$0
N	no lock <input type="checkbox"/>	+\$0

Step 12. Case/Edge Finish

For laminate case and doors (L), laminate case/veneer doors (C), or laminate case/glass doors (G)

76	light brown walnut <input type="checkbox"/>	+\$0
8Q	folkstone grey <input type="checkbox"/>	+\$0
91	white <input type="checkbox"/>	+\$0
98	studio white <input type="checkbox"/>	+\$0
CL	cool grey neutral <input type="checkbox"/>	+\$0
HM	natural maple <input type="checkbox"/>	+\$0
HP	light anigre <input type="checkbox"/>	+\$0
HX	aged cherry <input type="checkbox"/>	+\$0
HY	walnut on cherry <input type="checkbox"/>	+\$0
LA	light ash <input type="checkbox"/>	+\$0
LBA	clear on ash <input type="checkbox"/>	+\$0
LBR	phantom ecru <input type="checkbox"/>	+\$0
LBS	phantom cocoa <input type="checkbox"/>	+\$0
LBU	medium matte walnut <input type="checkbox"/>	+\$0
LBV	warm grey teak <input type="checkbox"/>	+\$0
LBB	oak on ash <input type="checkbox"/>	+\$0
LBC	walnut on ash <input type="checkbox"/>	+\$0
LBD	dark brown walnut <input type="checkbox"/>	+\$0
LBE	medium red walnut <input type="checkbox"/>	+\$0
LBF	neutral twill <input type="checkbox"/>	+\$0
LBG	sarum twill <input type="checkbox"/>	+\$0
LBH	earthen twill <input type="checkbox"/>	+\$0
LBJ	graphite twill <input type="checkbox"/>	+\$0
LBK	pewter mesh <input type="checkbox"/>	+\$0
LBL	steel mesh <input type="checkbox"/>	+\$0
LBM	crisp linen <input type="checkbox"/>	+\$0
LBN	classic linen <input type="checkbox"/>	+\$0
LBP	casual linen <input type="checkbox"/>	+\$0
LBQ	white twill <input type="checkbox"/>	+\$0
LU	soft white <input type="checkbox"/>	+\$0
WL	sandstone <input type="checkbox"/>	+\$0
WN	warm grey neutral <input type="checkbox"/>	+\$0

Wood Veneer

For veneer case and doors (W) or veneer case/glass doors (R)

2U	light brown walnut <input type="checkbox"/>	+\$0
40	dark brown walnut <input type="checkbox"/>	+\$0
ED	aged cherry <input type="checkbox"/>	+\$0
EK	medium red walnut <input type="checkbox"/>	+\$0
EW	medium matte walnut <input type="checkbox"/>	+\$0
ET	clear on ash <input type="checkbox"/>	+\$0
EU	oak on ash <input type="checkbox"/>	+\$0
EV	walnut on ash <input type="checkbox"/>	+\$0
UL	natural maple <input type="checkbox"/>	+\$0
UX	walnut on cherry <input type="checkbox"/>	+\$0

Step 13. Door/Edge Finish

For laminate case and doors (L)

76	light brown walnut <input type="checkbox"/>	+\$0
8Q	folkstone grey <input type="checkbox"/>	+\$0
91	white <input type="checkbox"/>	+\$0
98	studio white <input type="checkbox"/>	+\$0
CL	cool grey neutral <input type="checkbox"/>	+\$0
HM	natural maple <input type="checkbox"/>	+\$0
HP	light anigre <input type="checkbox"/>	+\$0
HX	aged cherry <input type="checkbox"/>	+\$0
HY	walnut on cherry <input type="checkbox"/>	+\$0
LA	light ash <input type="checkbox"/>	+\$0
LBA	clear on ash <input type="checkbox"/>	+\$0
LBR	phantom ecru <input type="checkbox"/>	+\$0
LBS	phantom cocoa <input type="checkbox"/>	+\$0
LBU	medium matte walnut <input type="checkbox"/>	+\$0
LBV	warm grey teak <input type="checkbox"/>	+\$0
LBB	oak on ash <input type="checkbox"/>	+\$0
LBC	walnut on ash <input type="checkbox"/>	+\$0
LBD	dark brown walnut <input type="checkbox"/>	+\$0
LBE	medium red walnut <input type="checkbox"/>	+\$0
LBF	neutral twill <input type="checkbox"/>	+\$0
LBG	sarum twill <input type="checkbox"/>	+\$0
LBH	earthen twill <input type="checkbox"/>	+\$0
LBJ	graphite twill <input type="checkbox"/>	+\$0
LBK	pewter mesh <input type="checkbox"/>	+\$0
LBL	steel mesh <input type="checkbox"/>	+\$0
LBM	crisp linen <input type="checkbox"/>	+\$0
LBN	classic linen <input type="checkbox"/>	+\$0
LBP	casual linen <input type="checkbox"/>	+\$0
LBQ	white twill <input type="checkbox"/>	+\$0
LU	soft white <input type="checkbox"/>	+\$0
WL	sandstone <input type="checkbox"/>	+\$0
WN	warm grey neutral <input type="checkbox"/>	+\$0

Wood Veneer

For laminate case/veneer doors (C) or veneer case and doors (W)

2U	light brown walnut <input type="checkbox"/>	+\$0
40	dark brown walnut <input type="checkbox"/>	+\$0
ED	aged cherry <input type="checkbox"/>	+\$0
EK	medium red walnut <input type="checkbox"/>	+\$0
EW	medium matte walnut <input type="checkbox"/>	+\$0
ET	clear on ash <input type="checkbox"/>	+\$0
EU	oak on ash <input type="checkbox"/>	+\$0
EV	walnut on ash <input type="checkbox"/>	+\$0
UL	natural maple <input type="checkbox"/>	+\$0
UX	walnut on cherry <input type="checkbox"/>	+\$0

Glass

For laminate case/glass doors (G) or veneer case/glass doors (R)

8Q	folkstone grey <input type="checkbox"/>	+\$0
91	white <input type="checkbox"/>	+\$0
98	studio white <input type="checkbox"/>	+\$0

Step 14. Top/Edge Finish

For 3/8" laminate thin top (3)

76	light brown walnut <input type="checkbox"/>	+\$0
8Q	folkstone grey <input type="checkbox"/>	+\$0
91	white <input type="checkbox"/>	+\$0
98	studio white <input type="checkbox"/>	+\$0
CL	cool grey neutral <input type="checkbox"/>	+\$0
HM	natural maple <input type="checkbox"/>	+\$0
HP	light anigre <input type="checkbox"/>	+\$0
HX	aged cherry <input type="checkbox"/>	+\$0
HY	walnut on cherry <input type="checkbox"/>	+\$0
LA	light ash <input type="checkbox"/>	+\$0
LBA	clear on ash <input type="checkbox"/>	+\$0
LBB	oak on ash <input type="checkbox"/>	+\$0
LBC	walnut on ash <input type="checkbox"/>	+\$0
LBD	dark brown walnut <input type="checkbox"/>	+\$0
LBE	medium red walnut <input type="checkbox"/>	+\$0
LBF	neutral twill <input type="checkbox"/>	+\$0
LBG	sarum twill <input type="checkbox"/>	+\$0
LBH	earthen twill <input type="checkbox"/>	+\$0
LBJ	graphite twill <input type="checkbox"/>	+\$0
LBK	pewter mesh <input type="checkbox"/>	+\$0
LBL	steel mesh <input type="checkbox"/>	+\$0
LBM	crisp linen <input type="checkbox"/>	+\$0
LBN	classic linen <input type="checkbox"/>	+\$0
LBP	casual linen <input type="checkbox"/>	+\$0
LBQ	white twill <input type="checkbox"/>	+\$0
LU	soft white <input type="checkbox"/>	+\$0
WL	sandstone <input type="checkbox"/>	+\$0
WN	warm grey neutral <input type="checkbox"/>	+\$0

Wood Veneer

For 3/8" veneer thin top (4)

2U	light brown walnut <input type="checkbox"/>	+\$0
40	dark brown walnut <input type="checkbox"/>	+\$0
ED	aged cherry <input type="checkbox"/>	+\$0
EK	medium red walnut <input type="checkbox"/>	+\$0
EW	medium matte walnut <input type="checkbox"/>	+\$0
ET	clear on ash <input type="checkbox"/>	+\$0
EU	oak on ash <input type="checkbox"/>	+\$0
EV	walnut on ash <input type="checkbox"/>	+\$0
UL	natural maple <input type="checkbox"/>	+\$0
UX	walnut on cherry <input type="checkbox"/>	+\$0

Step 15. Base/Foot/Edge Finish

Bright Sand Texture Paint		
<i>For 4"-high foot (4)</i>		
91	white <input type="checkbox"/>	+\$0
CL	cool grey neutral <input type="checkbox"/>	+\$0
G1	graphite <input type="checkbox"/>	+\$0
WN	warm grey neutral <input type="checkbox"/>	+\$0
Metallic Paint		
<i>For 4"-high foot (4)</i>		
CN	metallic champagne <input type="checkbox"/>	+\$0
EH	metallic bronze <input type="checkbox"/>	+\$0
MS	metallic silver <input type="checkbox"/>	+\$0

For 2 1/4"-high base (2) with laminate (L)

LBR	phantom ecru <input type="checkbox"/>	+\$0
LBS	phantom cocoa <input type="checkbox"/>	+\$0
LBU	medium matte walnut <input type="checkbox"/>	+\$0
LBV	warm grey teak <input type="checkbox"/>	+\$0
76	light brown walnut <input type="checkbox"/>	+\$0
8Q	folkstone grey <input type="checkbox"/>	+\$0
91	white <input type="checkbox"/>	+\$0
98	studio white <input type="checkbox"/>	+\$0
CL	cool grey neutral <input type="checkbox"/>	+\$0
HM	natural maple <input type="checkbox"/>	+\$0
HP	light anigre <input type="checkbox"/>	+\$0
HX	aged cherry <input type="checkbox"/>	+\$0
HY	walnut on cherry <input type="checkbox"/>	+\$0
LA	light ash <input type="checkbox"/>	+\$0
LBA	clear on ash <input type="checkbox"/>	+\$0
LBB	oak on ash <input type="checkbox"/>	+\$0
LBC	walnut on ash <input type="checkbox"/>	+\$0
LBD	dark brown walnut <input type="checkbox"/>	+\$0
LBE	medium red walnut <input type="checkbox"/>	+\$0
LBF	neutral twill <input type="checkbox"/>	+\$0
LBG	sarum twill <input type="checkbox"/>	+\$0
LBH	earthen twill <input type="checkbox"/>	+\$0
LBJ	graphite twill <input type="checkbox"/>	+\$0
LBK	pewter mesh <input type="checkbox"/>	+\$0
LBL	steel mesh <input type="checkbox"/>	+\$0
LBM	crisp linen <input type="checkbox"/>	+\$0
LBN	classic linen <input type="checkbox"/>	+\$0
LBP	casual linen <input type="checkbox"/>	+\$0
LBQ	white twill <input type="checkbox"/>	+\$0
LU	soft white <input type="checkbox"/>	+\$0
WL	sandstone <input type="checkbox"/>	+\$0
WN	warm grey neutral <input type="checkbox"/>	+\$0

For 2 1/4"-high base (2) with veneer (W)

2U	light brown walnut <input type="checkbox"/>	+\$0
40	dark brown walnut <input type="checkbox"/>	+\$0
ED	aged cherry <input type="checkbox"/>	+\$0
EK	medium red walnut <input type="checkbox"/>	+\$0
EW	medium matte walnut <input type="checkbox"/>	+\$0
ET	clear on ash <input type="checkbox"/>	+\$0
EU	oak on ash <input type="checkbox"/>	+\$0
EY	light anigre <input type="checkbox"/>	+\$0
UL	natural maple <input type="checkbox"/>	+\$0
UX	walnut on cherry <input type="checkbox"/>	+\$0

Wood Wardrobe Tower *continued*

Step 16. Lock Option

For lock (L)

KA	keyed alike <input type="checkbox"/>	-\$10
KC	keyed differently, chrome <input type="checkbox"/>	+\$0
KD	keyed differently, black <input type="checkbox"/>	+\$0

Wood Vertical Tower with Partial Enclosure FF56M.

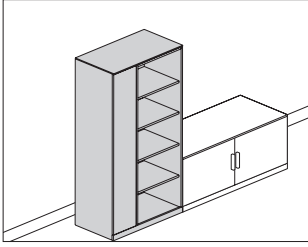

Product Information

Description

This freestanding tower has an enclosed wardrobe on one side and exposed shelves on the other. It is available with a 2 1/4"-high base or 4"-high architectural feet with 1" leveling glides. Top options are a finished case top or 3/8" laminate or veneer thin top. Tower doors have touch latches and optional locks.

Notes

Tower with finished case top aligns with top of bead on a frame attached tile. Adding a thin top increases overall tower height 1/2".

Finished case units have a split top.

Align like components next to like units: Finished case units with other finished case units, thin top units with other thin top units, 2 1/4" base storage units with other 2 1/4" base storage, and 4" foot storage with other 4" foot storage.

Tower matches style of wood overhead storage in FV43 series.

Actual tower widths are 23 7/8" (24), 29 7/8" (30), 35 7/8" (36), or 41 7/8" (42); actual depths are 14 7/8" (1), or 19 7/8" (2).

- 15" deep (1) matches overhead storage unit depth in FV43 series.
- 20" deep (2) matches Canvas low storage depth.

15"-deep units have a coat hook; 20"-deep units have coat rod in the wardrobe.

Storage compartment has 1 or more adjustable shelves that adjust in 1 1/4" increments.

Tower case is available in laminate or veneer; door in laminate, veneer, or back-painted glass; 3/8" thin top in laminate or veneer.

Asymmetric units will have 3 nominal door widths: 10", 12", and 15".

Glass doors are back-painted and writable with dry-erase marker. Glass doors cannot lock.

Grain direction is vertical on veneer, wood-grain, and patterned laminate case and fronts.

Dimensional illustration does not include all possible configurations.

For keyed-alike locks, see Keyed-Alike Information in appendices.

Dimensions

24", 30", 36", 42" Wide

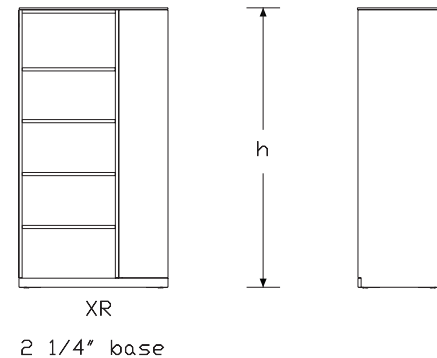
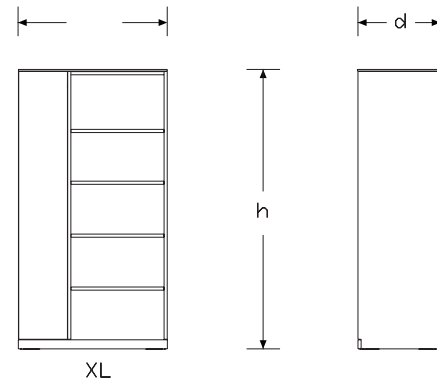

Wood Vertical Tower with Partial Enclosure *continued*

Specification Information

Step 1.

FF56M. A

Step 2. Height

3	42" high <input type="checkbox"/> A	+\$600
4	46" high <input type="checkbox"/> A	+\$650
5	53" high <input type="checkbox"/> A	+\$750
6	57" high <input type="checkbox"/> A	+\$800
7	68" high <input type="checkbox"/> A	+\$825

Step 3. Width

24	24" wide <input type="checkbox"/> A	+\$350
30	30" wide <input type="checkbox"/> A	+\$400
36	36" wide <input type="checkbox"/> A	+\$450
42	42" wide <input type="checkbox"/> A	+\$500

Step 4. Depth

1	15" deep <input type="checkbox"/> A	+\$200
2	20" deep <input type="checkbox"/> A	+\$250

Step 5. Base/Foot Height

2	2 1/4"-high base <input type="checkbox"/> A	+\$100
4	4"-high foot <input type="checkbox"/> A	+\$200

Step 6. Configuration

XL	asymmetric wardrobe left hinged door, open shelves right <input type="checkbox"/> A	+\$0
XR	open shelves left, asymmetric wardrobe right hinged door <input type="checkbox"/> A	+\$0

Step 7. Case/Door Material

For 42" high (3), 46" high (4), or 53" high (5) with 24" wide (24)

L	laminate case and door <input type="checkbox"/> A	+\$363
C	laminate case/veneer door <input type="checkbox"/> A	+\$1300
W	veneer case and door <input type="checkbox"/> A	+\$2082
G	laminate case/glass door <input type="checkbox"/> A	+\$650
R	veneer case/glass door <input type="checkbox"/> A	+\$1432

For 42" high (3), 46" high (4), or 53" high (5) with 30" wide (30)

L	laminate case and door <input type="checkbox"/> A	+\$476
C	laminate case/veneer door <input type="checkbox"/> A	+\$1501
W	veneer case and door <input type="checkbox"/> A	+\$2433
G	laminate case/glass door <input type="checkbox"/> A	+\$700
R	veneer case/glass door <input type="checkbox"/> A	+\$1632

For 42" high (3), 46" high (4), or 53" high (5) with 36" wide (36)

L	laminate case and door <input type="checkbox"/> A	+\$600
C	laminate case/veneer door <input type="checkbox"/> A	+\$1876
W	veneer case and door <input type="checkbox"/> A	+\$2958
G	laminate case/glass door <input type="checkbox"/> A	+\$825
R	veneer case/glass door <input type="checkbox"/> A	+\$1607

For 42" high (3), 46" high (4), or 53" high (5) with 42" wide (42)

L	laminate case and door <input type="checkbox"/> A	+\$738
C	laminate case/veneer door <input type="checkbox"/> A	+\$2251
W	veneer case and door <input type="checkbox"/> A	+\$3483
G	laminate case/glass door <input type="checkbox"/> A	+\$1100
R	veneer case/glass door <input type="checkbox"/> A	+\$2332

For 57" high (6) or 68" high (7) with 24" wide (24)

L	laminate case and door <input type="checkbox"/> A	+\$382
C	laminate case/veneer door <input type="checkbox"/> A	+\$1445
W	veneer case and door <input type="checkbox"/> A	+\$2570
G	laminate case/glass door <input type="checkbox"/> A	+\$800
R	veneer case/glass door <input type="checkbox"/> A	+\$1925

For 57" high (6) or 68" high (7) with 30" wide (30)

L	laminate case and door <input type="checkbox"/> A	+\$502
C	laminate case/veneer door <input type="checkbox"/> A	+\$1814
W	veneer case and door <input type="checkbox"/> A	+\$3246
G	laminate case/glass door <input type="checkbox"/> A	+\$850
R	veneer case/glass door <input type="checkbox"/> A	+\$2282

For 57" high (6) or 68" high (7) with 36" wide (36)

L	laminate case and door <input type="checkbox"/> A	+\$672
C	laminate case/veneer door <input type="checkbox"/> A	+\$2189
W	veneer case and door <input type="checkbox"/> A	+\$3946
G	laminate case/glass door <input type="checkbox"/> A	+\$1025
R	veneer case/glass door <input type="checkbox"/> A	+\$2782

For 57" high (6) or 68" high (7) with 42" wide (42)

L	laminate case and door <input type="checkbox"/> A	+\$792
C	laminate case/veneer door <input type="checkbox"/> A	+\$2724
W	veneer case and door <input type="checkbox"/> A	+\$4806
G	laminate case/glass door <input type="checkbox"/> A	+\$1300
R	veneer case/glass door <input type="checkbox"/> A	+\$3382

Step 8. Base Material

L	laminate <input type="checkbox"/> A	+\$100
W	veneer <input type="checkbox"/> A	+\$150

Wood Vertical Tower with Partial Enclosure *continued*

Step 9. Top		
T	finished case top <input type="checkbox"/>	+\$0
3	3/8" laminate thin top <input type="checkbox"/>	+\$150
4	3/8" veneer thin top <input type="checkbox"/>	+\$300
N	no top for use with 3/8" common thin top <input type="checkbox"/>	+\$50

Step 10. Lock		
L	lock <input type="checkbox"/>	+\$0
N	no lock <input type="checkbox"/>	+\$0

Step 11. Case/Edge Finish		
---------------------------	--	--

For laminate case and door (L), laminate case/veneer door (C), or laminate case/glass door (G)

76	light brown walnut <input type="checkbox"/>	+\$0
8Q	folkstone grey <input type="checkbox"/>	+\$0
91	white <input type="checkbox"/>	+\$0
98	studio white <input type="checkbox"/>	+\$0
CL	cool grey neutral <input type="checkbox"/>	+\$0
HM	natural maple <input type="checkbox"/>	+\$0
HP	light anigre <input type="checkbox"/>	+\$0
HX	aged cherry <input type="checkbox"/>	+\$0
HY	walnut on cherry <input type="checkbox"/>	+\$0
LA	light ash <input type="checkbox"/>	+\$0
LBA	clear on ash <input type="checkbox"/>	+\$0
LBR	phantom ecru <input type="checkbox"/>	+\$0
LBS	phantom cocoa <input type="checkbox"/>	+\$0
LBU	medium matte walnut <input type="checkbox"/>	+\$0
LBV	warm grey teak <input type="checkbox"/>	+\$0
LBB	oak on ash <input type="checkbox"/>	+\$0
LBC	walnut on ash <input type="checkbox"/>	+\$0
LBD	dark brown walnut <input type="checkbox"/>	+\$0
LBE	medium red walnut <input type="checkbox"/>	+\$0
LBF	neutral twill <input type="checkbox"/>	+\$0
LBG	sarum twill <input type="checkbox"/>	+\$0
LBH	earthen twill <input type="checkbox"/>	+\$0
LBJ	graphite twill <input type="checkbox"/>	+\$0
LBK	pewter mesh <input type="checkbox"/>	+\$0
LBL	steel mesh <input type="checkbox"/>	+\$0
LBM	crisp linen <input type="checkbox"/>	+\$0
LBN	classic linen <input type="checkbox"/>	+\$0
LBP	casual linen <input type="checkbox"/>	+\$0
LBQ	white twill <input type="checkbox"/>	+\$0
LU	soft white <input type="checkbox"/>	+\$0
WL	sandstone <input type="checkbox"/>	+\$0
WN	warm grey neutral <input type="checkbox"/>	+\$0

Wood Veneer		
<i>For veneer case and door (W) or veneer case/glass door (R)</i>		
2U	light brown walnut <input type="checkbox"/>	+\$0
40	dark brown walnut <input type="checkbox"/>	+\$0
ED	aged cherry <input type="checkbox"/>	+\$0
EK	medium red walnut <input type="checkbox"/>	+\$0
EW	medium matte walnut <input type="checkbox"/>	+\$0
ET	clear on ash <input type="checkbox"/>	+\$0
EU	oak on ash <input type="checkbox"/>	+\$0
EV	walnut on ash <input type="checkbox"/>	+\$0
UL	natural maple <input type="checkbox"/>	+\$0
UX	walnut on cherry <input type="checkbox"/>	+\$0

Wood Vertical Tower with Partial Enclosure *continued*

Step 12. Door/Edge Finish

For laminate case and door (L)

76	light brown walnut <input type="checkbox"/>	+\$0
8Q	folkstone grey <input type="checkbox"/>	+\$0
91	white <input type="checkbox"/>	+\$0
98	studio white <input type="checkbox"/>	+\$0
CL	cool grey neutral <input type="checkbox"/>	+\$0
HM	natural maple <input type="checkbox"/>	+\$0
HP	light anigre <input type="checkbox"/>	+\$0
HX	aged cherry <input type="checkbox"/>	+\$0
HY	walnut on cherry <input type="checkbox"/>	+\$0
LA	light ash <input type="checkbox"/>	+\$0
LBA	clear on ash <input type="checkbox"/>	+\$0
LBR	phantom ecru <input type="checkbox"/>	+\$0
LBS	phantom cocoa <input type="checkbox"/>	+\$0
LBU	medium matte walnut <input type="checkbox"/>	+\$0
LBV	warm grey teak <input type="checkbox"/>	+\$0
LBB	oak on ash <input type="checkbox"/>	+\$0
LBC	walnut on ash <input type="checkbox"/>	+\$0
LBD	dark brown walnut <input type="checkbox"/>	+\$0
LBE	medium red walnut <input type="checkbox"/>	+\$0
LBF	neutral twill <input type="checkbox"/>	+\$0
LBG	sarum twill <input type="checkbox"/>	+\$0
LBH	earthen twill <input type="checkbox"/>	+\$0
LBJ	graphite twill <input type="checkbox"/>	+\$0
LBK	pewter mesh <input type="checkbox"/>	+\$0
LBL	steel mesh <input type="checkbox"/>	+\$0
LBM	crisp linen <input type="checkbox"/>	+\$0
LBN	classic linen <input type="checkbox"/>	+\$0
LBP	casual linen <input type="checkbox"/>	+\$0
LBQ	white twill <input type="checkbox"/>	+\$0
LU	soft white <input type="checkbox"/>	+\$0
WL	sandstone <input type="checkbox"/>	+\$0
WN	warm grey neutral <input type="checkbox"/>	+\$0

For laminate case/veneer door (C) or veneer case and door (W)

2U	light brown walnut <input type="checkbox"/>	+\$0
40	dark brown walnut <input type="checkbox"/>	+\$0
ED	aged cherry <input type="checkbox"/>	+\$0
EK	medium red walnut <input type="checkbox"/>	+\$0
EW	medium matte walnut <input type="checkbox"/>	+\$0
ET	clear on ash <input type="checkbox"/>	+\$0
EU	oak on ash <input type="checkbox"/>	+\$0
EV	walnut on ash <input type="checkbox"/>	+\$0
UL	natural maple <input type="checkbox"/>	+\$0
UX	walnut on cherry <input type="checkbox"/>	+\$0

Glass

For laminate case/glass door (G) or veneer case/glass door (R)

8Q	folkstone grey <input type="checkbox"/>	+\$0
91	white <input type="checkbox"/>	+\$0
98	studio white <input type="checkbox"/>	+\$0

Step 13. Top/Edge Finish

For 3/8" laminate thin top (3)

76	light brown walnut <input type="checkbox"/>	+\$0
8Q	folkstone grey <input type="checkbox"/>	+\$0
91	white <input type="checkbox"/>	+\$0
98	studio white <input type="checkbox"/>	+\$0
CL	cool grey neutral <input type="checkbox"/>	+\$0
HM	natural maple <input type="checkbox"/>	+\$0
HP	light anigre <input type="checkbox"/>	+\$0
HX	aged cherry <input type="checkbox"/>	+\$0
HY	walnut on cherry <input type="checkbox"/>	+\$0
LA	light ash <input type="checkbox"/>	+\$0
LBA	clear on ash <input type="checkbox"/>	+\$0
LBR	phantom ecru <input type="checkbox"/>	+\$0
LBS	phantom cocoa <input type="checkbox"/>	+\$0
LBU	medium matte walnut <input type="checkbox"/>	+\$0
LBV	warm grey teak <input type="checkbox"/>	+\$0
LBB	oak on ash <input type="checkbox"/>	+\$0
LBC	walnut on ash <input type="checkbox"/>	+\$0
LBD	dark brown walnut <input type="checkbox"/>	+\$0
LBE	medium red walnut <input type="checkbox"/>	+\$0
LBF	neutral twill <input type="checkbox"/>	+\$0
LBG	sarum twill <input type="checkbox"/>	+\$0
LBH	earthen twill <input type="checkbox"/>	+\$0
LBJ	graphite twill <input type="checkbox"/>	+\$0
LBK	pewter mesh <input type="checkbox"/>	+\$0
LBL	steel mesh <input type="checkbox"/>	+\$0
LBM	crisp linen <input type="checkbox"/>	+\$0
LBN	classic linen <input type="checkbox"/>	+\$0
LBP	casual linen <input type="checkbox"/>	+\$0
LBQ	white twill <input type="checkbox"/>	+\$0
LU	soft white <input type="checkbox"/>	+\$0
WL	sandstone <input type="checkbox"/>	+\$0
WN	warm grey neutral <input type="checkbox"/>	+\$0

Wood Vertical Tower with Partial Enclosure *continued*

Wood Veneer

For 3/8" veneer thin top (4)

2U	light brown walnut <input type="checkbox"/>	+\$0
40	dark brown walnut <input type="checkbox"/>	+\$0
ED	aged cherry <input type="checkbox"/>	+\$0
EK	medium red walnut <input type="checkbox"/>	+\$0
EW	medium matte walnut <input type="checkbox"/>	+\$0
ET	clear on ash <input type="checkbox"/>	+\$0
EU	oak on ash <input type="checkbox"/>	+\$0
EV	walnut on ash <input type="checkbox"/>	+\$0
UL	natural maple <input type="checkbox"/>	+\$0
UX	walnut on cherry <input type="checkbox"/>	+\$0

Step 14. Base/Foot Finish

Bright Sand Texture Paint

For 4"-high foot (4)

91	white <input type="checkbox"/>	+\$0
CL	cool grey neutral <input type="checkbox"/>	+\$0
G1	graphite <input type="checkbox"/>	+\$0
WN	warm grey neutral <input type="checkbox"/>	+\$0

Metallic Paint

For 4"-high foot (4)

CN	metallic champagne <input type="checkbox"/>	+\$0
EH	metallic bronze <input type="checkbox"/>	+\$0
MS	metallic silver <input type="checkbox"/>	+\$0

For 2 1/4"-high base (2) with laminate (L)

76	light brown walnut <input type="checkbox"/>	+\$0
8Q	folkstone grey <input type="checkbox"/>	+\$0
91	white <input type="checkbox"/>	+\$0
98	studio white <input type="checkbox"/>	+\$0
CL	cool grey neutral <input type="checkbox"/>	+\$0
HM	natural maple <input type="checkbox"/>	+\$0
HP	light anigre <input type="checkbox"/>	+\$0
HX	aged cherry <input type="checkbox"/>	+\$0
HY	walnut on cherry <input type="checkbox"/>	+\$0
LA	light ash <input type="checkbox"/>	+\$0
LBA	clear on ash <input type="checkbox"/>	+\$0
LBR	phantom ecru <input type="checkbox"/>	+\$0
LBS	phantom cocoa <input type="checkbox"/>	+\$0
LBU	medium matte walnut <input type="checkbox"/>	+\$0
LBV	warm grey teak <input type="checkbox"/>	+\$0
LBB	oak on ash <input type="checkbox"/>	+\$0
LBC	walnut on ash <input type="checkbox"/>	+\$0
LBD	dark brown walnut <input type="checkbox"/>	+\$0
LBE	medium red walnut <input type="checkbox"/>	+\$0
LBF	neutral twill <input type="checkbox"/>	+\$0
LBG	sarum twill <input type="checkbox"/>	+\$0
LBH	earthen twill <input type="checkbox"/>	+\$0
LBJ	graphite twill <input type="checkbox"/>	+\$0
LBK	pewter mesh <input type="checkbox"/>	+\$0
LBL	steel mesh <input type="checkbox"/>	+\$0
LBM	crisp linen <input type="checkbox"/>	+\$0
LBN	classic linen <input type="checkbox"/>	+\$0
LBP	casual linen <input type="checkbox"/>	+\$0
LBQ	white twill <input type="checkbox"/>	+\$0
LU	soft white <input type="checkbox"/>	+\$0
WL	sandstone <input type="checkbox"/>	+\$0
WN	warm grey neutral <input type="checkbox"/>	+\$0

Wood Veneer

For 2 1/4"-high base (2) with veneer (W)

2U	light brown walnut <input type="checkbox"/>	+\$0
40	dark brown walnut <input type="checkbox"/>	+\$0
ED	aged cherry <input type="checkbox"/>	+\$0
EK	medium red walnut <input type="checkbox"/>	+\$0
EW	medium matte walnut <input type="checkbox"/>	+\$0
ET	clear on ash <input type="checkbox"/>	+\$0
EU	oak on ash <input type="checkbox"/>	+\$0
EV	walnut on ash <input type="checkbox"/>	+\$0
UL	natural maple <input type="checkbox"/>	+\$0
UX	walnut on cherry <input type="checkbox"/>	+\$0

Wood Vertical Tower with Partial Enclosure *continued*

Step 15. Lock Option

For lock (L)

KA	keyed alike <input type="checkbox"/>	-\$10
KC	keyed differently, chrome <input type="checkbox"/>	+\$0
KD	keyed differently, black <input type="checkbox"/>	+\$0

Wood Vertical Storage Cabinet, FF50M. Thin Top

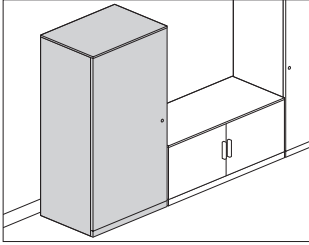

Product Information

Description

This freestanding cabinet is fully enclosed and has a $\frac{3}{8}$ "-high laminate or veneer top and the choice of a laminate case and front, veneer case and front, or laminate case with veneer front. It is available with 4"-high architectural feet with 1" leveling glides, or a 2 $\frac{1}{4}$ "-high base with $\frac{3}{4}$ " leveling glides. The cabinet is available with a variety of interior configurations with options for wardrobe, shelves, and pedestal drawers. 12"-, 15"- and 24"-wide cabinets have a single door that covers both sides of the cabinet; 30"-wide cabinet has separate doors for the wardrobe and shelves/drawers. Cabinet door(s) have automatic spring catches, and locks.

Actual cabinet widths are 11 $\frac{7}{8}$ ", 14 $\frac{7}{8}$ ", 23 $\frac{7}{8}$ ", or 29 $\frac{7}{8}$ "; actual depths are 19 $\frac{7}{8}$ " or 23 $\frac{7}{8}$ ".

The wardrobe includes a coat hook.

The storage compartment has 1 or more adjustable shelves that adjust in 1 $\frac{1}{4}$ " increments.

Drawers have full-extension ball-bearing slides. File drawers on 15"-wide cabinet accommodate side-to-side filing of letter-size hanging files. File drawers on 24"-wide and 30"-wide cabinets accommodate front-to-back filing of letter-size hanging files.

Notes

For additional product options, see Vary Easy Program in Appendices.

Grain direction is vertical on veneer and wood-grain laminate fronts.

Cabinet with shelves has the following number of adjustable shelves:

Cabinet Height—Number of Shelves

42"-high—2 adjustable shelves

46"-high—2 adjustable shelves

57"-high—3 adjustable shelves

68"-high—4 adjustable shelves

Cabinet with shelves/file(s) is configured as follows:

Cabinet Height—Shelves & Drawers

42"-high—1 fixed shelf, 1 adjustable shelf, 1 file drawer

46"-high—1 fixed shelf, 1 adjustable shelf, 1 file drawer

57"-high—1 fixed shelf, 1 adjustable shelf, 2 file drawers

68"-high—1 fixed shelf, 2 adjustable shelves, 2 file drawers

Cabinet with shelves/box(s)/file is configured as follows:

Cabinet Height—Shelves & Drawers

42"-high—1 fixed shelf, 1 adjustable shelf, 1 box drawer, 1 file drawer

46"-high—1 fixed shelf, 1 adjustable shelf, 1 box drawer, 1 file drawer

57"-high—1 fixed shelf, 1 adjustable shelf, 2 box drawers, 1 file drawer

68"-high—1 fixed shelf, 2 adjustable shelves, 2 box drawers, 1 file drawer

drawer

Dimensional illustrations do not include all possible configurations.

For keyed-alike locks, see Keyed-Alike Information in Appendices.

Dimensions

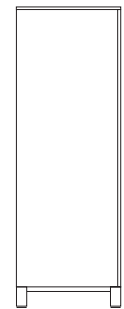
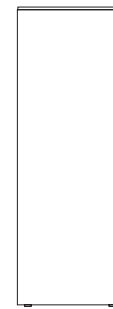
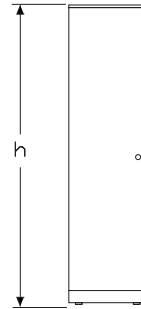
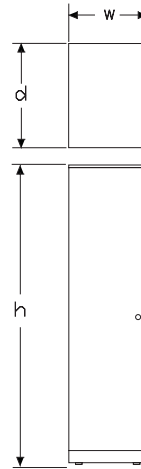

2 1/4" Base

4" Foot

12" Wide

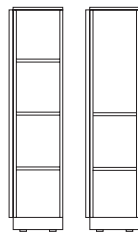

SL,SR WL,WR

15" Wide

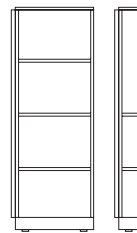

SL,SR WL,WR



DL,DR

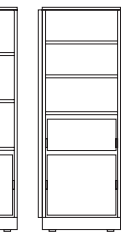

EL,ER

24",30" Wide

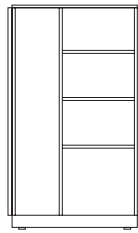

BL,BR

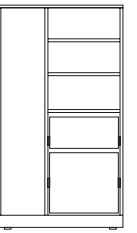

CL,CR

Wood Vertical Storage Cabinet, Thin Top *continued*

Specification Information

Step 1.

FF50M.

Step 2. Height

4 42" high
5 46" high
6 57" high
7 68" high

Step 3. Width

For 42" high (4) or 46" high (5)

12 12" wide
15 15" wide
24 24" wide
30 30" wide

For 57" high (6) or 68" high (7)

24 24" wide
30 30" wide

Step 4. Depth

20 20" deep
24 24" deep

Step 5. Base/Foot Height

2 2 1/4"-high base
4 4"-high foot

Step 6. Configuration

For 12" wide (12)

SL shelves, left-hinged door
SR shelves, right-hinged door
WL wardrobe with shelves, left-hinged door
WR wardrobe with shelves, right-hinged door

For 15" wide (15)

SL shelves, left-hinged door
SR shelves, right-hinged door
WL wardrobe with shelves, left-hinged door
WR wardrobe with shelves, right-hinged door
DL shelves/file(s), left-hinged door
DR shelves/file(s), right-hinged door
EL shelves/box(s)/file, left-hinged door
ER shelves/box(s)/file, right-hinged door

For 24" wide (24) or 30" wide (30)

BL wardrobe left, shelves/file(s) right
BR shelves/file(s) left, wardrobe right
CL wardrobe left, shelves/box(s)/file right
CR shelves/box(s)/file left, wardrobe right

Step 7. Case/Door Material

For 2 1/4"-high base (2)

L laminate
C laminate case/veneer door
W veneer

For 4"-high foot (4)

L laminate
C laminate case/veneer door

Step 8. Top Material

3 3/8" laminate top
4 3/8" veneer top

Step 9. Lock

L lock

Prices for Steps 1-9.

		202BLL3L	202BLL4L	202BLC3L	202BLC4L	202BLW3L	202BLW4L
FF50M. 4	24	\$2974	3189	3419	3634	5245	5460
	30	\$3093	3362	3554	3823	5409	5678
5	24	\$3093	3308	3419	3634	5464	5678
	30	\$3210	3479	3554	3823	5627	5895
6	24	\$3210	3426	3690	3905	5680	5895
	30	\$3330	3597	3827	4095	5844	6112
7	24	\$3330	3544	3827	4042	5897	6112
	30	\$3447	3717	3962	4231	6062	6331

		202SLL3L	202SLL4L	202SLC3L	202SLC4L	202SLW3L	202SLW4L
FF50M. 4	12	\$1808	1915	2170	2277	3362	3470
	15	\$1997	2104	2277	2384	3470	3577
5	12	\$1862	1969	2235	2342	3465	3573
	15	\$2029	2135	2490	2596	3708	3814

		202BRL3L	202BRL4L	202BRC3L	202BRC4L	202BRW3L	202BRW4L
FF50M. 4	24	\$2974	3189	3419	3634	5245	5460
	30	\$3093	3362	3554	3823	5409	5678
5	24	\$3093	3308	3419	3634	5464	5678
	30	\$3210	3479	3554	3823	5627	5895

Wood Vertical Storage Cabinet,
Thin Top *continued*

Canvas Office Landscape® Wood Case Cabinets and Bookcases (Legacy Products)

	6	24	\$3210	3426	3690	3905	5680	5895
		30	\$3330	3597	3827	4095	5844	6112
	7	24	\$3330	3544	3827	4042	5897	6112
		30	\$3447	3717	3962	4231	6062	6331
			202SRL3L	202SRL4L	202SRC3L	202SRC4L	202SRW3L	202SRW4L
FF50M. 4	12		\$1808	1915	2170	2277	3362	3470
	15		\$1997	2104	2277	2384	3470	3577
	5	12	\$1862	1969	2235	2342	3465	3573
		15	\$2029	2135	2490	2596	3708	3814
			202CLL3L	202CLL4L	202CLC3L	202CLC4L	202CLW3L	202CLW4L
FF50M. 4	24		\$2974	3189	3419	3634	5245	5460
	30		\$3093	3362	3554	3823	5409	5678
	5	24	\$3093	3308	3419	3634	5464	5678
		30	\$3210	3479	3554	3823	5627	5895
	6	24	\$3210	3426	3690	3905	5680	5895
		30	\$3330	3597	3827	4095	5844	6112
	7	24	\$3330	3544	3827	4042	5897	6112
		30	\$3447	3717	3962	4231	6062	6331
			202WLL3L	202WLL4L	202WLC3L	202WLC4L	202WLW3L	202WLW4L
FF50M. 4	12		\$1674	1781	2009	2117	3104	3212
	15		\$1997	2104	2277	2384	3470	3577
	5	12	\$1722	1830	2069	2177	3200	3308
		15	\$2019	2405	2298	2063	3480	3587
			202CRL3L	202CRL4L	202CRC3L	202CRC4L	202CRW3L	202CRW4L
FF50M. 4	24		\$2974	3189	3419	3634	5245	5460
	30		\$3093	3362	3554	3823	5409	5678
	5	24	\$3093	3308	3419	3634	5464	5678
		30	\$3210	3479	3554	3823	5627	5895
	6	24	\$3210	3426	3690	3905	5680	5895
		30	\$3330	3597	3827	4095	5844	6112
	7	24	\$3330	3544	3827	4042	5897	6112
		30	\$3447	3717	3962	4231	6062	6331
			202WRL3L	202WRL4L	202WRC3L	202WRC4L	202WRW3L	202WRW4L
FF50M. 4	12		\$1674	1781	2009	2117	3104	3212
	15		\$1997	2104	2277	2384	3470	3577
	5	12	\$1722	1830	2069	2177	3200	3308
		15	\$2019	2126	2298	2258	3480	3587
			202DLL3L	202DLL4L	202DLC3L	202DLC4L	202DLW3L	202DLW4L
FF50M. 4	15		\$1997	2104	2277	2384	3470	3577
	5	15	\$2050	2157	2342	2451	3465	3573

			202DRL3L	202DRL4L	202DRC3L	202DRC4L	202DRW3L	202DRW4L
FF50M. 4	15		\$1997	2104	2277	2384	3470	3577
	5	15	\$2050	2157	2342	2451	3465	3573
			202ELL3L	202ELL4L	202ELC3L	202ELC4L	202ELW3L	202ELW4L
FF50M. 4	15		\$1997	2104	2277	2384	3470	3577
	5	15	\$2050	2157	2342	2451	3357	3465
			202ERL3L	202ERL4L	202ERC3L	202ERC4L	202ERW3L	202ERW4L
FF50M. 4	15		\$1997	2104	2277	2384	3470	3577
	5	15	\$2050	2157	2342	2451	3357	3465
			204BLL3L	204BLL4L	204BLC3L	204BLC4L	204SLL3L	204SLL4L
FF50M. 4	12		—	—	—	—	\$1891	1998
	15		—	—	—	—	\$2079	2186
	24		\$3056	3272	3500	3717	—	—
	30		\$3175	3444	3636	3905	—	—
	5	12	—	—	—	—	\$1943	2051
		15	—	—	—	—	\$2381	2360
	24		\$3175	3389	3500	3717	—	—
	30		\$3292	3561	3636	3905	—	—
	6	24	\$3292	3508	3772	3988	—	—
		30	\$3411	3681	3908	4178	—	—
	7	24	\$3411	3627	3908	4124	—	—
		30	\$3530	3798	4045	4313	—	—
			204SLC3L	204SLC4L	204BRL3L	204BRL4L	204BRC3L	204BRC4L
FF50M. 4	12		\$2251	2359	—	—	—	—
	15		\$2359	2466	—	—	—	—
	24		—	—	\$3056	3272	3500	3717
	30		—	—	\$3175	3444	3636	3905
	5	12	\$2317	2425	—	—	—	—
		15	\$2425	2403	—	—	—	—
	24		—	—	\$3175	3389	3500	3717
	30		—	—	\$3292	3561	3636	3905
	6	24	—	—	\$3292	3508	3772	3988
		30	—	—	\$3411	3681	3908	4178
	7	24	—	—	\$3411	3627	3908	4124
		30	—	—	\$3530	3798	4045	4313
			204SRL3L	204SRL4L	204SRC3L	204SRC4L	204CLL3L	204CLL4L
FF50M. 4	12		\$1891	1998	2251	2359	—	—
	15		\$2079	2186	2359	2466	—	—
	24		—	—	—	—	\$3056	3272
	30		—	—	—	—	\$3175	3444

Wood Vertical Storage Cabinet,
Thin Top *continued*

5	12	\$1943	2051	2317	2425	—	—
	15	\$2381	2360	2425	2403	—	—
	24	—	—	—	—	\$3175	3389
	30	—	—	—	—	\$3292	3561
6	24	—	—	—	—	\$3292	3508
	30	—	—	—	—	\$3411	3681
7	24	—	—	—	—	\$3411	3627
	30	—	—	—	—	\$3530	3798
		204CLC3L	204CLC4L	204WLL3L	204WLL4L	204WLC3L	204WLC4L
FF50M. 4	12	—	—	\$1756	1864	2093	2201
	15	—	—	\$2079	2186	2359	2466
	24	\$3500	3717	—	—	—	—
	30	\$3636	3905	—	—	—	—
5	12	—	—	\$1805	1913	2151	2258
	15	—	—	\$2122	2102	2036	2145
	24	\$3500	3717	—	—	—	—
	30	\$3636	3905	—	—	—	—
6	24	\$3772	3988	—	—	—	—
	30	\$3908	4178	—	—	—	—
7	24	\$3908	4124	—	—	—	—
	30	\$4045	4313	—	—	—	—
		204CRL3L	204CRL4L	204CRC3L	204CRC4L	204WRL3L	204WRL4L
FF50M. 4	12	—	—	—	—	\$1756	1864
	15	—	—	—	—	\$2079	2186
	24	\$3056	3272	3500	3717	—	—
	30	\$3175	3444	3636	3905	—	—
5	12	—	—	—	—	\$1805	1913
	15	—	—	—	—	\$2122	2102
	24	\$3175	3389	3500	3717	—	—
	30	\$3292	3561	3636	3905	—	—
6	24	\$3292	3508	3772	3988	—	—
	30	\$3411	3681	3908	4178	—	—
7	24	\$3411	3627	3908	4124	—	—
	30	\$3530	3798	4045	4313	—	—
		204WRC3L	204WRC4L	204DLL3L	204DLL4L	204DLC3L	204DLC4L
FF50M. 4	12	\$2093	2201	—	—	—	—
	15	\$2359	2466	2079	2186	2359	2466
5	12	\$2151	2258	—	—	—	—
	15	\$2036	2145	2132	2240	2425	2532
		204DRL3L	204DRL4L	204DRC3L	204DRC4L	204ELL3L	204ELL4L
FF50M. 4	15	\$2079	2186	2359	2466	2079	2186
5	15	\$2132	2240	2425	2532	2132	2240

		204ELC3L	204ELC4L	204ERL3L	204ERL4L	204ERC3L	204ERC4L
FF50M. 4	15	\$2359	2466	2079	2186	2359	2466
5	15	\$2425	2532	2132	2240	2425	2532
		242BLL3L	242BLL4L	242BLC3L	242BLC4L	242BLW3L	242BLW4L
FF50M. 4	24	\$3034	3253	3488	3707	5351	5572
	30	\$3155	3430	3627	3901	5518	5793
5	24	\$3155	3375	3488	3707	5574	5793
	30	\$3276	3551	3627	3901	5741	6016
6	24	\$3276	3495	3765	3985	5796	6016
	30	\$3396	3670	3904	4179	5962	6238
7	24	\$3396	3617	3904	4124	6018	6238
	30	\$3518	3792	4044	4318	6187	6460
		242SLL3L	242SLL4L	242SLC3L	242SLC4L	242SLW3L	242SLW4L
FF50M. 4	12	\$1845	1955	2213	2322	3430	3540
	15	\$2036	2147	2322	2432	3540	3650
5	12	\$1900	2009	2280	2390	3536	3647
	15	\$2345	2323	2390	2367	2303	2280
		242BRL3L	242BRL4L	242BRC3L	242BRC4L	242BRW3L	242BRW4L
FF50M. 4	24	\$3034	3253	3488	3707	5351	5572
	30	\$3155	3430	3627	3901	5518	5793
5	24	\$3155	3375	3488	3707	5574	5793
	30	\$3276	3551	3627	3901	5741	6016
6	24	\$3276	3495	3765	3985	5796	6016
	30	\$3396	3670	3904	4179	5962	6238
7	24	\$3396	3617	3904	4124	6018	6238
	30	\$3518	3792	4044	4318	6187	6460
		242SRL3L	242SRL4L	242SRC3L	242SRC4L	242SRW3L	242SRW4L
FF50M. 4	12	\$1845	1955	2213	2322	3430	3540
	15	\$2036	2147	2322	2432	3540	3650
5	12	\$1900	2009	2280	2390	3536	3647
	15	\$2345	2323	2390	2367	2303	2280
		242CLL3L	242CLL4L	242CLC3L	242CLC4L	242CLW3L	242CLW4L
FF50M. 4	24	\$3034	3253	3488	3707	5351	5572
	30	\$3155	3430	3627	3901	5518	5793
5	24	\$3155	3375	3488	3707	5574	5793
	30	\$3276	3551	3627	3901	5741	6016
6	24	\$3276	3495	3765	3985	5796	6016
	30	\$3396	3670	3904	4179	5962	6238
7	24	\$3396	3617	3904	4124	6018	6238
	30	\$3518	3792	4044	4318	6187	6460

Canvas Office Landscape® Wood Case Cabinets and Bookcases (Legacy Products)

Wood Vertical Storage Cabinet,
Thin Top *continued*

Canvas Office Landscape® Wood Case Cabinets and Bookcases (Legacy Products)

		242WLL3L	242WLL4L	242WLC3L	242WLC4L	242WLW3L	242WLW4L
FF50M. 4	12	\$1708	1817	2050	2160	3168	3278
	15	\$2036	2147	2322	2432	3540	3650
	5	\$1758	1868	2111	2220	3264	3375
	15	\$2082	2060	2126	2104	2037	2016
		242CRL3L	242CRL4L	242CRC3L	242CRC4L	242CRW3L	242CRW4L
FF50M. 4	24	\$3034	3253	3488	3707	5351	5572
	30	\$3155	3430	3627	3901	5518	5793
	5	\$3155	3375	3488	3707	5574	5793
	30	\$3276	3551	3627	3901	5741	6016
6	24	\$3276	3495	3765	3985	5796	6016
	30	\$3396	3670	3904	4179	5962	6238
7	24	\$3396	3617	3904	4124	6018	6238
	30	\$3518	3792	4044	4318	6187	6460
		242WRL3L	242WRL4L	242WRC3L	242WRC4L	242WRW3L	242WRW4L
FF50M. 4	12	\$1708	1817	2050	2160	3168	3278
	15	\$2036	2147	2322	2432	3540	3650
	5	\$1758	1868	2111	2220	3264	3375
	15	\$2082	2060	2126	2104	2037	2016
		242DLL3L	242DLL4L	242DLC3L	242DLC4L	242DLW3L	242DLW4L
FF50M. 4	15	\$2036	2147	2322	2432	3540	3650
	5	\$2093	2203	2390	2499	3536	3647
		242DRL3L	242DRL4L	242DRC3L	242DRC4L	242DRW3L	242DRW4L
FF50M. 4	15	\$2036	2147	2322	2432	3540	3650
	5	\$2093	2203	2390	2499	3536	3647
		242ELL3L	242ELL4L	242ELC3L	242ELC4L	242ELW3L	242ELW4L
FF50M. 4	15	\$2036	2147	2322	2432	3540	3650
	5	\$2093	2203	2390	2499	3427	3536
		242ERL3L	242ERL4L	242ERC3L	242ERC4L	242ERW3L	242ERW4L
FF50M. 4	15	\$2036	2147	2322	2432	3540	3650
	5	\$2093	2203	2390	2499	3427	3536
		244BLL3L	244BLL4L	244BLC3L	244BLC4L	244SLL3L	244SLL4L
FF50M. 4	12	—	—	—	—	\$1927	2036
	15	—	—	—	—	\$2119	2228
	24	\$3118	3337	3488	3707	—	—
	30	\$3238	3512	3627	3901	—	—
5	12	—	—	—	—	\$1983	2093
	15	—	—	—	—	\$2428	2406
24		\$3238	3457	3488	3707	—	—
	30	\$3357	3633	3627	3901	—	—

6	24	\$3357	3578	3765	3985	—	—
	30	\$3479	3754	3904	4179	—	—
	7	\$3479	3698	3904	4124	—	—
	30	\$3599	3874	4044	4318	—	—
		244SLC3L	244SLC4L	244BRL3L	244BRL4L	244BRC3L	244BRC4L
FF50M. 4	12	\$2213	2322	—	—	—	—
	15	\$2322	2432	—	—	—	—
	24	—	—	\$3118	3337	3488	3707
	30	—	—	\$3238	3512	3627	3901
5	12	\$2280	2390	—	—	—	—
	15	\$2390	2367	—	—	—	—
24		—	—	\$3238	3457	3488	3707
	30	—	—	\$3357	3633	3627	3901
6	24	—	—	\$3357	3578	3765	3985
	30	—	—	\$3479	3754	3904	4179
7	24	—	—	\$3479	3698	3904	4124
	30	—	—	\$3599	3874	4044	4318
		244SRL3L	244SRL4L	244SRC3L	244SRC4L	244CLL3L	244CLL4L
FF50M. 4	12	\$1927	2036	2213	2322	—	—
	15	\$2119	2228	2322	2432	—	—
	24	—	—	—	—	\$3118	3337
	30	—	—	—	—	\$3238	3512
5	12	\$1983	2093	2280	2390	—	—
	15	\$2428	2406	2390	2367	—	—
24		—	—	—	—	\$3238	3457
	30	—	—	—	—	\$3357	3633
6	24	—	—	—	—	\$3357	3578
	30	—	—	—	—	\$3479	3754
7	24	—	—	—	—	\$3479	3698
	30	—	—	—	—	\$3599	3874
		244CLC3L	244CLC4L	244WLL3L	244WLL4L	244WLC3L	244WLC4L
FF50M. 4	12	—	—	\$1790	1900	2050	2160
	15	—	—	\$2119	2228	2322	2432
	24	\$3488	3707	—	—	—	—
	30	\$3627	3901	—	—	—	—
5	12	—	—	\$1840	1951	2111	2220
	15	—	—	\$2164	2142	2126	2104
24		\$3488	3707	—	—	—	—
	30	\$3627	3901	—	—	—	—
6	24	\$3765	3985	—	—	—	—
	30	\$3904	4179	—	—	—	—
7	24	\$3904	4124	—	—	—	—
	30	\$4044	4318	—	—	—	—

Wood Vertical Storage Cabinet, Thin Top *continued*

		244CRL3L	244CRL4L	244CRC3L	244CRC4L	244WRL3L	244WRL4L
FF50M. 4	12	—	—	—	—	\$1790	1900
	15	—	—	—	—	\$2119	2228
	24	\$3118	3337	3488	3707	—	—
	30	\$3238	3512	3627	3901	—	—
5	12	—	—	—	—	\$1840	1951
	15	—	—	—	—	\$2164	2142
	24	\$3238	3457	3488	3707	—	—
	30	\$3357	3633	3627	3901	—	—
6	24	\$3357	3578	3765	3985	—	—
	30	\$3479	3754	3904	4179	—	—
7	24	\$3479	3698	3904	4124	—	—
	30	\$3599	3874	4044	4318	—	—

		244WRC3L	244WRC4L	244DLL3L	244DLL4L	244DLC3L	244DLC4L
FF50M. 4	12	\$2050	2160	—	—	—	—
	15	\$2322	2432	2119	2228	2322	2432
5	12	\$2111	2220	—	—	—	—
	15	\$2126	2104	2175	2284	2390	2499

		244DRL3L	244DRL4L	244DRC3L	244DRC4L	244ELL3L	244ELL4L
FF50M. 4	15	\$2119	2228	2322	2432	2119	2228
5	15	\$2175	2284	2390	2499	2175	2284

		244ELC3L	244ELC4L	244ERL3L	244ERL4L	244ERC3L	244ERC4L
FF50M. 4	15	\$2322	2432	2119	2228	2322	2432
5	15	\$2390	2499	2175	2284	2390	2499

Step 10. Case Finish

Solid-Color Laminate

For laminate (L) or laminate case/veneer door (C)

8Q	folkstone grey A	+\$0
91	white A	+\$0
98	studio white	+\$0
CL	cool grey neutral A	+\$0
LU	soft white A	+\$0
WL	sandstone A	+\$0
WN	warm grey neutral A	+\$0

Linen Laminate

For laminate (L) or laminate case/veneer door (C)

LBM	crisp linen	+\$0
LBN	classic linen	+\$0
LBP	casual linen	+\$0

Mesh Laminate

For laminate (L) or laminate case/veneer door (C)

LBK	pewter mesh	+\$0
LBL	steel mesh	+\$0

Twill Laminate

For laminate (L) or laminate case/veneer door (C)

LBF	neutral twill	+\$0
LBG	sarum twill	+\$0
LBH	earthen twill	+\$0
LBJ	graphite twill	+\$0
LBQ	white twill	+\$0

Wood-Grain Laminate

For laminate (L) or laminate case/veneer door (C)

HM	natural maple A	+\$0
HP	light anigre A	+\$0
LBA	clear on ash	+\$0
LBR	phantom ecru	+\$0
LBS	phantom cocoa	+\$0
LBU	medium matte walnut	+\$0
LBV	warm grey teak	+\$0
LBB	oak on ash	+\$0
LBC	walnut on ash	+\$0
LBD	dark brown walnut	+\$0
LBE	medium red walnut	+\$0
76	light brown walnut A	+\$0
HX	aged cherry A	+\$0
HY	walnut on cherry A	+\$0

Wood Veneer

For veneer (W)

2U	light brown walnut A	+\$0
40	dark brown walnut A	+\$0
ED	aged cherry A	+\$0
EK	medium red walnut A	+\$0
EW	medium matte walnut A	+\$0
ET	clear on ash A	+\$0
EU	oak on ash A	+\$0
EV	walnut on ash A	+\$0
UL	natural maple A	+\$0
UX	walnut on cherry A	+\$0

Wood Vertical Storage Cabinet, Thin Top *continued*

Step 11. Door Finish

Solid-Color Laminate

For laminate (L)

8Q	folkstone grey <input type="checkbox"/>	+\$0
91	white <input type="checkbox"/>	+\$0
98	studio white	+\$0
CL	cool grey neutral <input type="checkbox"/>	+\$0
LU	soft white <input type="checkbox"/>	+\$0
WL	sandstone <input type="checkbox"/>	+\$0
WN	warm grey neutral <input type="checkbox"/>	+\$0

Linen Laminate

For laminate (L)

LBM	crisp linen	+\$0
LBN	classic linen	+\$0
LBP	casual linen	+\$0

Mesh Laminate

For laminate (L)

LBK	pewter mesh	+\$0
LBL	steel mesh	+\$0

Twill Laminate

For laminate (L)

LBF	neutral twill	+\$0
LBG	sarum twill	+\$0
LBH	earthen twill	+\$0
LBJ	graphite twill	+\$0
LBQ	white twill	+\$0

Wood-Grain Laminate

For laminate (L)

HM	natural maple <input type="checkbox"/>	+\$0
HP	light anigre <input type="checkbox"/>	+\$0
LBA	clear on ash	+\$0
LBR	phantom ecru	+\$0
LBS	phantom cocoa	+\$0
LBU	medium matte walnut	+\$0
LBV	warm grey teak	+\$0
LBB	oak on ash	+\$0
LBC	walnut on ash	+\$0
LBD	dark brown walnut	+\$0
LBE	medium red walnut	+\$0
76	light brown walnut <input type="checkbox"/>	+\$0
HX	aged cherry <input type="checkbox"/>	+\$0
HY	walnut on cherry <input type="checkbox"/>	+\$0

Wood Veneer

For laminate case/veneer door (C) or veneer (W)

2U	light brown walnut <input type="checkbox"/>	+\$0
40	dark brown walnut <input type="checkbox"/>	+\$0
ED	aged cherry <input type="checkbox"/>	+\$0
EK	medium red walnut <input type="checkbox"/>	+\$0
EW	medium matte walnut <input type="checkbox"/>	+\$0
ET	clear on ash <input type="checkbox"/>	+\$0
EU	oak on ash <input type="checkbox"/>	+\$0
EV	walnut on ash <input type="checkbox"/>	+\$0
UL	natural maple <input type="checkbox"/>	+\$0
UX	walnut on cherry <input type="checkbox"/>	+\$0

Step 12. Top Finish

Solid-Color Laminate

For $\frac{3}{8}$ " laminate top (3)

8Q	folkstone grey <input type="checkbox"/>	+\$0
91	white <input type="checkbox"/>	+\$0
98	studio white	+\$0
CL	cool grey neutral <input type="checkbox"/>	+\$0
LU	soft white <input type="checkbox"/>	+\$0
WL	sandstone <input type="checkbox"/>	+\$0
WN	warm grey neutral <input type="checkbox"/>	+\$0

Linen Laminate

For $\frac{3}{8}$ " laminate top (3)

LBM	crisp linen	+\$0
LBN	classic linen	+\$0
LBP	casual linen	+\$0

Mesh Laminate

For $\frac{3}{8}$ " laminate top (3)

LBK	pewter mesh	+\$0
LBL	steel mesh	+\$0

Twill Laminate

For $\frac{3}{8}$ " laminate top (3)

LBF	neutral twill	+\$0
LBG	sarum twill	+\$0
LBH	earthen twill	+\$0
LBJ	graphite twill	+\$0
LBQ	white twill	+\$0

Wood Vertical Storage Cabinet, Thin Top *continued*

Wood-Grain Laminate

For $\frac{3}{8}$ " laminate top (3)

HM	natural maple [A]	+\$0
HP	light anigre [A]	+\$0
LBA	clear on ash	+\$0
LBR	phantom ecru	+\$0
LBS	phantom cocoa	+\$0
LBU	medium matte walnut	+\$0
LBV	warm grey teak	+\$0
LBB	oak on ash	+\$0
LBC	walnut on ash	+\$0
LBD	dark brown walnut	+\$0
LBE	medium red walnut	+\$0
76	light brown walnut [A]	+\$0
HX	aged cherry [A]	+\$0
HY	walnut on cherry [A]	+\$0

Wood Veneer

For $\frac{3}{8}$ " veneer top (4)

2U	light brown walnut [A]	+\$0
40	dark brown walnut [A]	+\$0
ED	aged cherry [A]	+\$0
EK	medium red walnut [A]	+\$0
EW	medium matte walnut [A]	+\$0
ET	clear on ash [A]	+\$0
EU	oak on ash [A]	+\$0
EV	walnut on ash [A]	+\$0
UL	natural maple [A]	+\$0
UX	walnut on cherry [A]	+\$0

Step 13. Foot Finish

For 4"-high foot (4)

8Q	folkstone grey [A]	+\$0
98	studio white [A]	+\$0
WL	sandstone [A]	+\$0

Bright Sand Texture Paint

91	white [A]	+\$0
CL	cool grey neutral [A]	+\$0
G1	graphite [A]	+\$0
WN	warm grey neutral [A]	+\$0

Metallic Paint

CN	metallic champagne [A]	+\$0
EH	metallic bronze [A]	+\$0
MS	metallic silver [A]	+\$0

Step 14. Lock Option

KA	keyed alike [A]	-\$10
KC	keyed differently, chrome [A]	+\$0
KD	keyed differently, black [A]	+\$0

Wood Freestanding Bookcase

FF300.

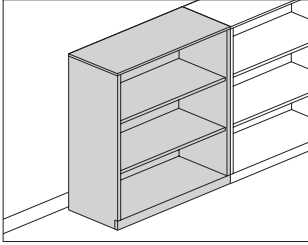

Canvas Office Landscape® Wood Case Cabinets and Bookcases (Legacy Products)

Product Information

Description

This bookcase provides open storage and display space. It has a 3/8"-high laminate or veneer top with a laminate or veneer case. It is available with 4"-high architectural feet or a 2 1/4"-high base with 1" leveling glides. Includes 1 or more adjustable shelves, based on height. Actual bookcase widths are 29 7/8" or 35 7/8"; actual depth is 13 7/8".

Notes

For additional product options, see Vary Easy Program in Appendices. Shelves adjust in 1/4" increments.

Dimensions

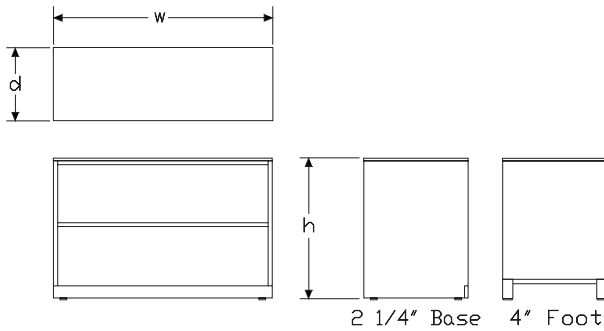

Specification Information

Step 1.

FF300. [A]

Step 2. Height

- 22** 22" high [A]
- 27** 27" high [A]
- 42** 42" high [A]
- 46** 46" high [A]

Step 3. Width

- 30** 30" wide [A]
- 36** 36" wide [A]

Step 4. Depth

- 14** 14" deep [A]

Step 5. Base/Foot Height

- 2** 2 1/4"-high base [A]
- 4** 4"-high foot [A]

Step 6. Case/Base Material

For 2 1/4"-high base (2)

- L** laminate [A]
- C** laminate case/veneer base [A]
- W** veneer [A]

For 4"-high foot (4)

- L** laminate [A]

Step 7. Top

- 03** 3/8" laminate top [A]
- 04** 3/8" veneer top [A]

Prices for Steps 1-7.

	142L03	142L04	142C03	142C04	142W03	142W04
FF300. 22 30	\$1119	1350	1293	1522	1868	2118
36	\$1232	1462	1404	1635	2079	2330
27 30	\$1216	1447	1390	1620	2053	2302
36	\$1337	1568	1510	1741	2281	2531
42 30	\$1435	1665	1607	1836	2465	2716
36	\$1576	1808	1751	1981	2736	2983
46 30	\$1520	1752	1695	1924	2627	2876
36	\$1671	1903	1845	2075	2914	3164

Wood Freestanding Bookcase

continued

	144L03	144L04
FF300. 22 30	\$1205	1437
36	\$1317	1549
27 30	\$1303	1534
36	\$1424	1656
42 30	\$1520	1752
36	\$1664	1895
46 30	\$1607	1836
36	\$1759	1989

Step 8. Case Finish

Solid-Color Laminate

For laminate (L) or laminate case/veneer base (C)

8Q	folkstone grey <input type="checkbox"/>	+\$0
91	white <input type="checkbox"/>	+\$0
98	studio white	+\$0
CL	cool grey neutral <input type="checkbox"/>	+\$0
LU	soft white <input type="checkbox"/>	+\$0
WL	sandstone <input type="checkbox"/>	+\$0
WN	warm grey neutral <input type="checkbox"/>	+\$0

Linen Laminate

For laminate (L) or laminate case/veneer base (C)

LBM	crisp linen	+\$0
LBN	classic linen	+\$0
LBP	casual linen	+\$0

Mesh Laminate

For laminate (L) or laminate case/veneer base (C)

LBK	pewter mesh	+\$0
LBL	steel mesh	+\$0

Twill Laminate

For laminate (L) or laminate case/veneer base (C)

LBF	neutral twill	+\$0
LBG	sarum twill	+\$0
LBH	earthen twill	+\$0
LBJ	graphite twill	+\$0
LBQ	white twill	+\$0

Wood-Grain Laminate

For laminate (L) or laminate case/veneer base (C)

HM	natural maple <input type="checkbox"/>	+\$0
HP	light anigre <input type="checkbox"/>	+\$0
LBA	clear on ash	+\$0
LBR	phantom ecru	+\$0
LBS	phantom cocoa	+\$0
LBU	medium matte walnut	+\$0
LBV	warm grey teak	+\$0
LBB	oak on ash	+\$0
LBC	walnut on ash	+\$0
LBD	dark brown walnut	+\$0
LBE	medium red walnut	+\$0
76	light brown walnut <input type="checkbox"/>	+\$0
HX	aged cherry <input type="checkbox"/>	+\$0
HY	walnut on cherry <input type="checkbox"/>	+\$0

Wood Veneer

For veneer (W)

2U	light brown walnut <input type="checkbox"/>	+\$0
40	dark brown walnut <input type="checkbox"/>	+\$0
ED	aged cherry <input type="checkbox"/>	+\$0
EK	medium red walnut <input type="checkbox"/>	+\$0
EW	medium matte walnut <input type="checkbox"/>	+\$0
ET	clear on ash <input type="checkbox"/>	+\$0
EU	oak on ash <input type="checkbox"/>	+\$0
EV	walnut on ash <input type="checkbox"/>	+\$0
UL	natural maple <input type="checkbox"/>	+\$0
UX	walnut on cherry <input type="checkbox"/>	+\$0

Step 9. Top Finish

Solid-Color Laminate

For 3/8" laminate top (O3)

8Q	folkstone grey <input type="checkbox"/>	+\$0
91	white <input type="checkbox"/>	+\$0
98	studio white	+\$0
CL	cool grey neutral <input type="checkbox"/>	+\$0
LU	soft white <input type="checkbox"/>	+\$0
WL	sandstone <input type="checkbox"/>	+\$0
WN	warm grey neutral <input type="checkbox"/>	+\$0

Linen Laminate

For 3/8" laminate top (O3)

LBM	crisp linen	+\$0
LBN	classic linen	+\$0
LBP	casual linen	+\$0

Wood Freestanding Bookcase

continued

Canvas Office Landscape® Wood Case Cabinets and Bookcases (Legacy Products)

Mesh Laminate

For 3/8" laminate top (03)

LBK	pewter mesh	+\$0
LBL	steel mesh	+\$0

Twill Laminate

For 3/8" laminate top (03)

LBF	neutral twill	+\$0
LBG	sarum twill	+\$0
LBH	earthen twill	+\$0
LBJ	graphite twill	+\$0
LBQ	white twill	+\$0

Wood-Grain Laminate

For 3/8" laminate top (03)

HM	natural maple <input type="checkbox"/>	+\$0
HP	light anigre <input type="checkbox"/>	+\$0
LBA	clear on ash	+\$0
LBR	phantom ecru	+\$0
LBS	phantom cocoa	+\$0
LBU	medium matte walnut	+\$0
LBV	warm grey teak	+\$0
LBB	oak on ash	+\$0
LBC	walnut on ash	+\$0
LBD	dark brown walnut	+\$0
LBE	medium red walnut	+\$0
76	light brown walnut <input type="checkbox"/>	+\$0
HX	aged cherry <input type="checkbox"/>	+\$0
HY	walnut on cherry <input type="checkbox"/>	+\$0

Wood Veneer

For 3/8" veneer top (04)

2U	light brown walnut <input type="checkbox"/>	+\$0
40	dark brown walnut <input type="checkbox"/>	+\$0
ED	aged cherry <input type="checkbox"/>	+\$0
EK	medium red walnut <input type="checkbox"/>	+\$0
EW	medium matte walnut <input type="checkbox"/>	+\$0
ET	clear on ash <input type="checkbox"/>	+\$0
EU	oak on ash <input type="checkbox"/>	+\$0
EV	walnut on ash <input type="checkbox"/>	+\$0
UL	natural maple <input type="checkbox"/>	+\$0
UX	walnut on cherry <input type="checkbox"/>	+\$0

Step 10. Base Finish

For laminate (L)

8Q	folkstone grey <input type="checkbox"/>	+\$0
91	white <input type="checkbox"/>	+\$0
98	studio white	+\$0
CL	cool grey neutral <input type="checkbox"/>	+\$0
LU	soft white <input type="checkbox"/>	+\$0
WL	sandstone <input type="checkbox"/>	+\$0
WN	warm grey neutral <input type="checkbox"/>	+\$0

Linen Laminate

For laminate (L)

LBM	crisp linen	+\$0
LBN	classic linen	+\$0
LBP	casual linen	+\$0

Mesh Laminate

For laminate (L)

LBK	pewter mesh	+\$0
LBL	steel mesh	+\$0

Twill Laminate

For laminate (L)

LBF	neutral twill	+\$0
LBG	sarum twill	+\$0
LBH	earthen twill	+\$0
LBJ	graphite twill	+\$0
LBQ	white twill	+\$0

Wood-Grain Laminate

For laminate (L)

HM	natural maple <input type="checkbox"/>	+\$0
HP	light anigre <input type="checkbox"/>	+\$0
LBA	clear on ash	+\$0
LBR	phantom ecru	+\$0
LBS	phantom cocoa	+\$0
LBU	medium matte walnut	+\$0
LBV	warm grey teak	+\$0
LBB	oak on ash	+\$0
LBC	walnut on ash	+\$0
LBD	dark brown walnut	+\$0
LBE	medium red walnut	+\$0
76	light brown walnut <input type="checkbox"/>	+\$0
HX	aged cherry <input type="checkbox"/>	+\$0
HY	walnut on cherry <input type="checkbox"/>	+\$0

Wood Freestanding Bookcase

continued

Wood Veneer

For laminate case/veneer base (C) or veneer (W)

2U	light brown walnut <input type="checkbox"/>	+\$0
40	dark brown walnut <input type="checkbox"/>	+\$0
ED	aged cherry <input type="checkbox"/>	+\$0
EK	medium red walnut <input type="checkbox"/>	+\$0
EW	medium matte walnut <input type="checkbox"/>	+\$0
ET	clear on ash <input type="checkbox"/>	+\$0
EU	oak on ash <input type="checkbox"/>	+\$0
EV	walnut on ash <input type="checkbox"/>	+\$0
UL	natural maple <input type="checkbox"/>	+\$0
UX	walnut on cherry <input type="checkbox"/>	+\$0

For 4"-high foot (4)

91	white <input type="checkbox"/>	+\$0
CL	cool grey neutral <input type="checkbox"/>	+\$0
G1	graphite <input type="checkbox"/>	+\$0
WN	warm grey neutral <input type="checkbox"/>	+\$0

For 4"-high foot (4)

8Q	folkstone grey <input type="checkbox"/>	+\$0
98	studio white <input type="checkbox"/>	+\$0
WL	sandstone <input type="checkbox"/>	+\$0

Metallic Paint

For 4"-high foot (4)

CN	metallic champagne <input type="checkbox"/>	+\$0
EH	metallic bronze <input type="checkbox"/>	+\$0
MS	metallic silver <input type="checkbox"/>	+\$0

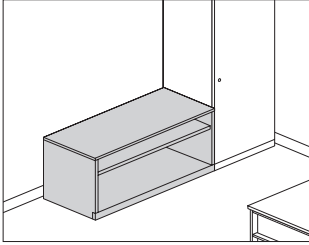

Product Information

Description

This credenza provides open storage and can be used freestanding or to support 1 end of a surface. It has a 3/8"-high or 1 1/4"-high laminate or veneer top with a laminate or veneer case. It is available with 4"-high architectural feet, 4"-high sleeveless architectural feet or a 2 1/4"-high base with 1" leveling glides.

Actual credenza widths are 29 7/8", 35 7/8", 41 7/8", 47 3/4", or 59 3/4"; actual depth is 19 7/8".

Notes

For additional product options, see Vary Easy Program in Appendices.

30"- and 36"-wide credenzas have no center divider and include 1 adjustable shelf. 42", 48", and 60"-wide credenzas have a center divider and include 2 adjustable shelves. Shelves adjust in 1 1/4" increments.

Credenza with 4"-high foot option (4) and 3/8" thin top can be used to support a Canvas wall-based frame. Order support bracket, low credenza-to-frame (FT292.) separately.

When using credenza to support 1 end of a surface, order 1 of the following products separately:

- Surface support, low credenza, adjustable height (FT299.)
- Surface support, low credenza, fixed height (FT298.)

Order optional wood credenza shelf (FF892.) separately.

To provide temporary guest seating on a credenza, order cushion top (FF891.) separately.

1 1/4" top (o6 and o7) is not removable and cannot be used to support a Canvas wall-based frame. The 1 1/4" top will add 5/8" to overall height of unit.

Please note that on the 4" sleeveless architectural foot (5) glides will be more visible.

Dimensions

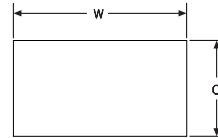

30",36" Wide

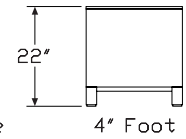
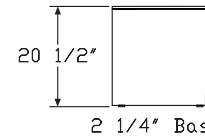
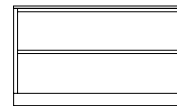

42",48",60" Wide

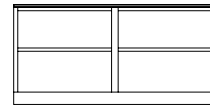

Wood Low Credenza, Open *continued*

Specification Information

Step 1.

FFC700. A

Step 2. Width

- 30 30" wide A
- 36 36" wide A
- 42 42" wide A
- 48 48" wide A
- 60 60" wide A

Step 3. Depth

20 20" deep A

Step 4. Base/Foot Height

- 2 2 1/4"-high base A
- 4 4"-high foot A
- 5 4" -high foot sleeveless A

Step 5. Case/Base Material

For 2 1/4"-high base (2)

- L laminate A
- C laminate case/veneer base A
- W veneer A

For 4"-high foot (4) or 4" -high foot sleeveless (5)

L laminate A

Step 6. Top

For laminate (L) or laminate case/veneer base (C)

- NT no top A
- 03 3/8" laminate top A
- 04 3/8" veneer top A
- 06 1 1/4" laminate top A
- 07 1 1/4" veneer top A

For veneer (W)

- NT no top A
- 04 3/8" veneer top A
- 07 1 1/4" veneer top A

Prices for Steps 1-6.

		2LNT	2L03	2L04	2L06	2L07	2CNT
FFC700.	30 20	\$1354	1467	1693	1347	1584	1523
	36 20	\$1450	1563	1790	1454	1680	1619

	42 20	\$1833	1947	2174	1838	2065	2003
	48 20	\$1924	2037	2264	1819	2046	2094
	60 20	\$2134	2247	2529	2028	2311	2304

		2C03	2C04	2C06	2C07	2WNT	2W04
FFC700.	30 20	\$1636	1863	1526	1754	2316	2936
	36 20	\$1732	1958	1623	1849	2491	3271
	42 20	\$2117	2342	2008	2233	3190	3543
	48 20	\$2208	2433	1989	2215	3326	3707
	60 20	\$2416	2699	2198	2481	3677	4088

		2W07	4LNT	4L03	4L04	4L06	4L07
FFC700.	30 20	\$2822	1438	1552	1777	1442	1668
	36 20	\$3157	1535	1647	1873	1538	1764
	42 20	\$3430	1919	2031	2257	1922	2148
	48 20	\$3481	2066	2179	2406	1961	2187
	60 20	\$3974	2275	2388	2670	2170	2452

		5LNT	5L03	5L04	5L06	5L07
FFC700.	30 20	\$1384	1497	1722	1388	1613
	36 20	\$1481	1593	1818	1484	1709
	42 20	\$1865	1977	2203	1868	2094
	48 20	\$2011	2124	2351	1906	2132
	60 20	\$2220	2333	2616	2115	2397

Step 7. Case Finish

For laminate (L) or laminate case/veneer base (C)

- LBM crisp linen A +\$0
- LBN classic linen A +\$0
- LBP casual linen A +\$0

For laminate (L) or laminate case/veneer base (C)

- LBK pewter mesh A +\$0
- LBL steel mesh A +\$0

Solid-Color Laminate

For laminate (L) or laminate case/veneer base (C)

- 8Q folkstone grey A +\$0
- 91 white A +\$0
- 98 studio white A +\$0
- CL cool grey neutral A +\$0
- LU soft white A +\$0
- WL sandstone A +\$0
- WN warm grey neutral A +\$0

Canvas Office Landscape® Wood Case Credenzas

Wood Low Credenza, Open *continued*

For laminate (L) or laminate case/veneer base (C)		
LBF	neutral twill A	+\$0
LBG	sarum twill A	+\$0
LBH	earthen twill A	+\$0
LBJ	graphite twill A	+\$0
LBQ	white twill A	+\$0

Wood-Grain Laminate		
For laminate (L) or laminate case/veneer base (C)		
HM	natural maple A	+\$0
HP	light anigre A	+\$0
LBA	clear on ash	+\$0
LBB	oak on ash	+\$0
LBC	walnut on ash	+\$0
LBD	dark brown walnut	+\$0
LBR	phantom ecru	+\$0
LBS	phantom cocoa	+\$0
LBU	medium matte walnut	+\$0
LBV	warm grey teak	+\$0
LBE	medium red walnut	+\$0
76	light brown walnut A	+\$0
HX	aged cherry A	+\$0
HY	walnut on cherry A	+\$0

Wood Veneer		
For veneer (W)		
2U	light brown walnut A	+\$0
40	dark brown walnut A	+\$0
ED	aged cherry A	+\$0
EK	medium red walnut A	+\$0
EW	medium matte walnut A	+\$0
ET	clear on ash A	+\$0
EU	oak on ash A	+\$0
EV	walnut on ash A	+\$0
UL	natural maple A	+\$0
UX	walnut on cherry A	+\$0

Step 8. Top Finish

For 3/8" laminate top (03) or 1/4" laminate top (06)		
LBM	crisp linen A	+\$0
LBN	classic linen A	+\$0
LBP	casual linen A	+\$0

For 3/8" laminate top (03) or 1/4" laminate top (06)		
LBK	pewter mesh A	+\$0
LBL	steel mesh A	+\$0

Solid-Color Laminate		
For 3/8" laminate top (03) or 1/4" laminate top (06)		
8Q	folkstone grey A	+\$0
91	white A	+\$0
98	studio white A	+\$0
CL	cool grey neutral A	+\$0
LU	soft white A	+\$0
WL	sandstone A	+\$0
WN	warm grey neutral A	+\$0

For 3/8" laminate top (03) or 1/4" laminate top (06)		
LBF	neutral twill A	+\$0
LBG	sarum twill A	+\$0
LBH	earthen twill A	+\$0
LBJ	graphite twill A	+\$0
LBQ	white twill A	+\$0

Wood-Grain Laminate		
For 3/8" laminate top (03) or 1/4" laminate top (06)		
HM	natural maple A	+\$0
HP	light anigre A	+\$0
LBA	clear on ash	+\$0
LBB	oak on ash	+\$0
LBC	walnut on ash	+\$0
LBD	dark brown walnut	+\$0
LBR	phantom ecru	+\$0
LBS	phantom cocoa	+\$0
LBU	medium matte walnut	+\$0
LBV	warm grey teak	+\$0
LBE	medium red walnut	+\$0
76	light brown walnut A	+\$0
HX	aged cherry A	+\$0
HY	walnut on cherry A	+\$0

Wood Veneer		
For 3/8" veneer top (04) or 1/4" veneer top (07)		
2U	light brown walnut A	+\$0
40	dark brown walnut A	+\$0
ED	aged cherry A	+\$0
EK	medium red walnut A	+\$0
EW	medium matte walnut A	+\$0
ET	clear on ash A	+\$0
EU	oak on ash A	+\$0
EV	walnut on ash A	+\$0
UL	natural maple A	+\$0
UX	walnut on cherry A	+\$0

Wood Low Credenza, Open *continued*

Step 9. Base Finish

For laminate (L)

LBM	crisp linen <input type="checkbox"/>	+\$0
LBN	classic linen <input type="checkbox"/>	+\$0
LBP	casual linen <input type="checkbox"/>	+\$0

For laminate (L)

LBK	pewter mesh <input type="checkbox"/>	+\$0
LBL	steel mesh <input type="checkbox"/>	+\$0

Solid-Color Laminate

For laminate (L)

8Q	folkstone grey <input type="checkbox"/>	+\$0
91	white <input type="checkbox"/>	+\$0
98	studio white <input type="checkbox"/>	+\$0
CL	cool grey neutral <input type="checkbox"/>	+\$0
LU	soft white <input type="checkbox"/>	+\$0
WL	sandstone <input type="checkbox"/>	+\$0
WN	warm grey neutral <input type="checkbox"/>	+\$0

For laminate (L)

LBF	neutral twill <input type="checkbox"/>	+\$0
LBG	sarum twill <input type="checkbox"/>	+\$0
LBH	earthen twill <input type="checkbox"/>	+\$0
LBJ	graphite twill <input type="checkbox"/>	+\$0
LBQ	white twill <input type="checkbox"/>	+\$0

Wood-Grain Laminate

For laminate (L)

HM	natural maple <input type="checkbox"/>	+\$0
HP	light anigre <input type="checkbox"/>	+\$0
LBA	clear on ash	+\$0
LBB	oak on ash	+\$0
LBC	walnut on ash	+\$0
LBD	dark brown walnut	+\$0
LBR	phantom ecru	+\$0
LBS	phantom cocoa	+\$0
LBU	medium matte walnut	+\$0
LBV	warm grey teak	+\$0
LBE	medium red walnut	+\$0
76	light brown walnut <input type="checkbox"/>	+\$0
HX	aged cherry <input type="checkbox"/>	+\$0
HY	walnut on cherry <input type="checkbox"/>	+\$0

Wood Veneer

For laminate case/veneer base (C) or veneer (W)

2U	light brown walnut <input type="checkbox"/>	+\$0
40	dark brown walnut <input type="checkbox"/>	+\$0
ED	aged cherry <input type="checkbox"/>	+\$0
EK	medium red walnut <input type="checkbox"/>	+\$0
EW	medium matte walnut <input type="checkbox"/>	+\$0
ET	clear on ash <input type="checkbox"/>	+\$0
EU	oak on ash <input type="checkbox"/>	+\$0
EV	walnut on ash <input type="checkbox"/>	+\$0
UL	natural maple <input type="checkbox"/>	+\$0
UX	walnut on cherry <input type="checkbox"/>	+\$0

Step 10. Foot Finish

For 4"-high foot (4) or 4"-high foot sleeveless (5)

91	white <input type="checkbox"/>	+\$0
CL	cool grey neutral <input type="checkbox"/>	+\$0
G1	graphite <input type="checkbox"/>	+\$0
WN	warm grey neutral <input type="checkbox"/>	+\$0
CN	metallic champagne <input type="checkbox"/>	+\$0
EH	metallic bronze <input type="checkbox"/>	+\$0
MS	metallic silver <input type="checkbox"/>	+\$0
8Q	folkstone grey <input type="checkbox"/>	+\$0
98	studio white <input type="checkbox"/>	+\$0
WL	sandstone <input type="checkbox"/>	+\$0

Wood Low Credenza, with Doors

FFC71A
FFC71K

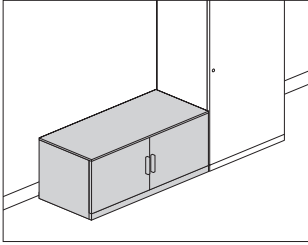

Product Information

Description

This credenza provides enclosed storage and can be used freestanding or to support 1 end of a surface. It has a $\frac{3}{8}$ "-high or $\frac{1}{4}$ "-high laminate or veneer top with a laminate or veneer case. It is available with 4"-high architectural feet, 4"-high sleeveless architectural feet or a $2\frac{1}{4}$ "-high base with 1" leveling glides.

Actual credenza widths are $29\frac{7}{8}$ ", $35\frac{7}{8}$ ", or $41\frac{7}{8}$ "; actual depth is $19\frac{7}{8}$ ".

Notes

For additional product options, see Vary Easy Program in Appendices. Arc pull option (A.) conforms to guidelines of Americans with Disabilities Act (ADA).

Grain direction is vertical on veneer and wood-grain laminate fronts.

30"- and 36"-wide credenzas have no center divider and include 1 adjustable shelf. 42"-wide credenza has a center divider and includes 2 adjustable shelves. Shelves adjust in $\frac{1}{4}$ " increments.

Credenza with 4"-high foot option (4) and $\frac{3}{8}$ " thin top can be used to support a Canvas wall-based frame. Order support bracket, low credenza-to-frame (FT292.) separately.

When using credenza to support 1 end of a surface, order 1 of the following products separately:

- Surface support, low credenza, adjustable height (FT299.)
- Surface support, low credenza, fixed height (FT298.)

To cover adjacent credenzas with a single top, specify credenzas with no top option (NT) and order credenza top (FF890.) separately.

$\frac{1}{4}$ " top (o6 and o7) is not removable and cannot be used to support a Canvas wall-based frame. The $\frac{1}{4}$ " top will add $\frac{5}{8}$ " to overall height of unit.

Please note that on the 4" sleeveless architectural foot (5) glides will be more visible.

Order optional wood credenza shelf (FF892.) separately.

To provide temporary guest seating on a credenza, order cushion top (FF891.) separately.

For keyed-alike locks, see Keyed-Alike Information in Appendices.

Dimensions

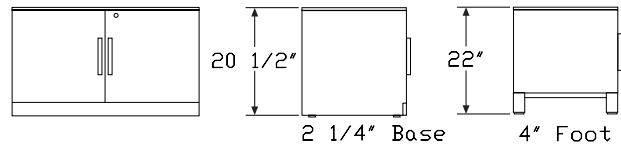
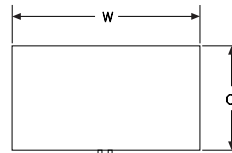

Wood Low Credenza, with Doors

continued

Specification Information	
Step 1.	
FFC71	A
Step 2. Pull Type	
A.	arc pull A
K.	bar pull A
Step 3. Width	
30	30" wide A
36	36" wide A
42	42" wide A
Step 4. Depth	
20	20" deep A
Step 5. Base/Foot Height	
2	2 1/4"-high base A
4	4"-high foot A
5	4" -high foot sleeveless A
Step 6. Case/Door Material	
<i>For 2 1/4"-high base (2)</i>	
L	laminata A
C	laminata case/veneer door A
W	veneer A
<i>For 4"-high foot (4) or 4" -high foot sleeveless (5)</i>	
L	laminata A
C	laminata case/veneer door A
Step 7. Top	
<i>For laminata (L) or laminata case/veneer door (C)</i>	
NT	no top A
03	3/8" laminata top A
04	3/8" veneer top A
06	1 1/4" laminata top A
07	1 1/4" veneer top A
<i>For veneer (W)</i>	
NT	no top A
04	3/8" veneer top A
07	1 1/4" veneer top A

Prices for Steps 1-7.							
		2LNT	2L03	2L04	2L06	2L07	2CNT
FFC71A.	30 20	\$1701	1810	2029	1704	1923	2061
	36 20	\$1893	2002	2221	1896	2115	2291
	42 20	\$2084	2193	2414	2087	2308	2523
		2C03	2C04	2C06	2C07	2WNT	2W04
FFC71A.	30 20	\$2172	2391	2066	2285	2710	3038
	36 20	\$2402	2622	2295	2516	3032	3362
	42 20	\$2632	2851	2526	2745	3354	3685
		2W07	4LNT	4L03	4L04	4L06	4L07
FFC71A.	30 20	\$2932	1782	1893	2112	1787	2006
	36 20	\$3256	1974	2084	2305	1978	2199
	42 20	\$3579	2167	2277	2496	2171	2390
		4CNT	4C03	4C04	4C06	4C07	5LNT
FFC71A.	30 20	\$2140	2251	2470	2145	2364	1728
	36 20	\$2370	2482	2701	2376	2595	1921
	42 20	\$2603	2712	2931	2606	2825	2113
		5L03	5L04	5L06	5L07	5CNT	5C03
FFC71A.	30 20	\$1839	2059	1732	1953	2087	2199
	36 20	\$2031	2251	1925	2145	2318	2428
	42 20	\$2223	2443	2117	2337	2549	2659
					5C04	5C06	5C07
FFC71A.	30 20				\$2418	2093	2312
	36 20				\$2647	2322	2541
	42 20				\$2878	2553	2772
		2LNT	2L03	2L04	2L06	2L07	2CNT
FFC71K.	30 20	\$1701	1810	2029	1704	1923	2061
	36 20	\$1893	2002	2221	1896	2115	2291
	42 20	\$2084	2193	2414	2087	2308	2523
		2C03	2C04	2C06	2C07	2WNT	2W04
FFC71K.	30 20	\$2172	2391	2066	2285	2710	3038
	36 20	\$2402	2622	2295	2516	3032	3362
	42 20	\$2632	2851	2526	2745	3354	3685
		2W07	4LNT	4L03	4L04	4L06	4L07
FFC71K.	30 20	\$2932	1782	1893	2112	1787	2006
	36 20	\$3256	1974	2084	2305	1978	2199
	42 20	\$3579	2167	2496	2496	2171	2390

Canvas Office Landscape® Wood Case Credenzas

Wood Low Credenza, with Doors

continued

Canvas Office Landscape® Wood Case Credenzas

		4CNT	4C03	4C04	4C06	4C07	5LNT
FFC71K.	30 20	\$2140	2251	2470	2145	2364	1728
	36 20	\$2370	2482	2701	2376	2595	1921
	42 20	\$2603	2712	2931	2606	2825	2113

		5L03	5L04	5L06	5L07	5CNT	5C03
FFC71K.	30 20	\$1839	2059	1732	1953	2087	2199
	36 20	\$2031	2251	1925	2145	2318	2428
	42 20	\$2223	2443	2117	2337	2549	2659

			5C04	5C06	5C07
FFC71K.	30 20		\$2418	2093	2312
	36 20		\$2647	2322	2541
	42 20		\$2878	2553	2772

Step 8. Case Finish

For laminate (L) or laminate case/veneer door (C)

LBM	crisp linen <input type="checkbox"/>	+\$0
LBN	classic linen <input type="checkbox"/>	+\$0
LBP	casual linen <input type="checkbox"/>	+\$0

For laminate (L) or laminate case/veneer door (C)

LBK	pewter mesh <input type="checkbox"/>	+\$0
LBL	steel mesh <input type="checkbox"/>	+\$0

Solid-Color Laminate

For laminate (L) or laminate case/veneer door (C)

8Q	folkstone grey <input type="checkbox"/>	+\$0
91	white <input type="checkbox"/>	+\$0
98	studio white <input type="checkbox"/>	+\$0
CL	cool grey neutral <input type="checkbox"/>	+\$0
LU	soft white <input type="checkbox"/>	+\$0
WL	sandstone <input type="checkbox"/>	+\$0
WN	warm grey neutral <input type="checkbox"/>	+\$0

For laminate (L) or laminate case/veneer door (C)

LBF	neutral twill <input type="checkbox"/>	+\$0
LBG	sarum twill <input type="checkbox"/>	+\$0
LBH	earthen twill <input type="checkbox"/>	+\$0
LBJ	graphite twill <input type="checkbox"/>	+\$0
LBQ	white twill <input type="checkbox"/>	+\$0

Wood-Grain Laminate

For laminate (L) or laminate case/veneer door (C)

HM	natural maple <input type="checkbox"/>	+\$0
HP	light anigre <input type="checkbox"/>	+\$0
LBA	clear on ash	+\$0
LBB	oak on ash	+\$0
LBC	walnut on ash	+\$0
LBD	dark brown walnut	+\$0
LBR	phantom ecru	+\$0
LBS	phantom cocoa	+\$0
LBU	medium matte walnut	+\$0
LBV	warm grey teak	+\$0
LBE	medium red walnut	+\$0
76	light brown walnut <input type="checkbox"/>	+\$0
HX	aged cherry <input type="checkbox"/>	+\$0
HY	walnut on cherry <input type="checkbox"/>	+\$0

Wood Veneer

For veneer (W)

2U	light brown walnut <input type="checkbox"/>	+\$0
40	dark brown walnut <input type="checkbox"/>	+\$0
ED	aged cherry <input type="checkbox"/>	+\$0
EK	medium red walnut <input type="checkbox"/>	+\$0
EW	medium matte walnut <input type="checkbox"/>	+\$0
ET	clear on ash <input type="checkbox"/>	+\$0
EU	oak on ash <input type="checkbox"/>	+\$0
EV	walnut on ash <input type="checkbox"/>	+\$0
UL	natural maple <input type="checkbox"/>	+\$0
UX	walnut on cherry <input type="checkbox"/>	+\$0

Step 9. Door Finish

For laminate (L)

LBM	crisp linen <input type="checkbox"/>	+\$0
LBN	classic linen <input type="checkbox"/>	+\$0
LBP	casual linen <input type="checkbox"/>	+\$0

For laminate (L)

LBK	pewter mesh <input type="checkbox"/>	+\$0
LBL	steel mesh <input type="checkbox"/>	+\$0

Wood Low Credenza, with Doors

continued

Solid-Color Laminate

For laminate (L)

8Q	folkstone grey <input type="checkbox"/>	+\$0
91	white <input type="checkbox"/>	+\$0
98	studio white <input type="checkbox"/>	+\$0
CL	cool grey neutral <input type="checkbox"/>	+\$0
LU	soft white <input type="checkbox"/>	+\$0
WL	sandstone <input type="checkbox"/>	+\$0
WN	warm grey neutral <input type="checkbox"/>	+\$0

For laminate (L)

LBF	neutral twill <input type="checkbox"/>	+\$0
LBG	sarum twill <input type="checkbox"/>	+\$0
LBH	earthen twill <input type="checkbox"/>	+\$0
LBJ	graphite twill <input type="checkbox"/>	+\$0
LBQ	white twill <input type="checkbox"/>	+\$0

Wood-Grain Laminate

For laminate (L)

HM	natural maple <input type="checkbox"/>	+\$0
HP	light anigre <input type="checkbox"/>	+\$0
LBA	clear on ash	+\$0
LBB	oak on ash	+\$0
LBC	walnut on ash	+\$0
LBD	dark brown walnut	+\$0
LBR	phantom ecru	+\$0
LBS	phantom cocoa	+\$0
LBU	medium matte walnut	+\$0
LBV	warm grey teak	+\$0
LBE	medium red walnut	+\$0
76	light brown walnut <input type="checkbox"/>	+\$0
HX	aged cherry <input type="checkbox"/>	+\$0
HY	walnut on cherry <input type="checkbox"/>	+\$0

Wood Veneer

For laminate case/veneer door (C) or veneer (W)

2U	light brown walnut <input type="checkbox"/>	+\$0
40	dark brown walnut <input type="checkbox"/>	+\$0
ED	aged cherry <input type="checkbox"/>	+\$0
EK	medium red walnut <input type="checkbox"/>	+\$0
EW	medium matte walnut <input type="checkbox"/>	+\$0
ET	clear on ash <input type="checkbox"/>	+\$0
EU	oak on ash <input type="checkbox"/>	+\$0
EV	walnut on ash <input type="checkbox"/>	+\$0
UL	natural maple <input type="checkbox"/>	+\$0
UX	walnut on cherry <input type="checkbox"/>	+\$0

Step 10. Top Finish

For 3/8" laminate top (03) or 1 1/4" laminate top (06)

LBM	crisp linen <input type="checkbox"/>	+\$0
LBN	classic linen <input type="checkbox"/>	+\$0
LBP	casual linen <input type="checkbox"/>	+\$0

For 3/8" laminate top (03) or 1 1/4" laminate top (06)

LBK	pewter mesh <input type="checkbox"/>	+\$0
LBL	steel mesh <input type="checkbox"/>	+\$0

Solid-Color Laminate

For 3/8" laminate top (03) or 1 1/4" laminate top (06)

8Q	folkstone grey <input type="checkbox"/>	+\$0
91	white <input type="checkbox"/>	+\$0
98	studio white <input type="checkbox"/>	+\$0
CL	cool grey neutral <input type="checkbox"/>	+\$0
LU	soft white <input type="checkbox"/>	+\$0
WL	sandstone <input type="checkbox"/>	+\$0
WN	warm grey neutral <input type="checkbox"/>	+\$0

For 3/8" laminate top (03) or 1 1/4" laminate top (06)

LBF	neutral twill <input type="checkbox"/>	+\$0
LBG	sarum twill <input type="checkbox"/>	+\$0
LBH	earthen twill <input type="checkbox"/>	+\$0
LBJ	graphite twill <input type="checkbox"/>	+\$0
LBQ	white twill <input type="checkbox"/>	+\$0

Wood-Grain Laminate

For 3/8" laminate top (03) or 1 1/4" laminate top (06)

HM	natural maple <input type="checkbox"/>	+\$0
HP	light anigre <input type="checkbox"/>	+\$0
LBA	clear on ash	+\$0
LBB	oak on ash	+\$0
LBC	walnut on ash	+\$0
LBD	dark brown walnut	+\$0
LBR	phantom ecru	+\$0
LBS	phantom cocoa	+\$0
LBU	medium matte walnut	+\$0
LBV	warm grey teak	+\$0
LBE	medium red walnut	+\$0
76	light brown walnut <input type="checkbox"/>	+\$0
HX	aged cherry <input type="checkbox"/>	+\$0
HY	walnut on cherry <input type="checkbox"/>	+\$0

Wood Low Credenza, with Doors

continued

Canvas Office Landscape® Wood Case Credenzas

Wood Veneer

For $\frac{3}{8}$ " veneer top (04) or $\frac{1}{4}$ " veneer top (07)

2U	light brown walnut <input type="checkbox"/>	+\$0
40	dark brown walnut <input type="checkbox"/>	+\$0
ED	aged cherry <input type="checkbox"/>	+\$0
EK	medium red walnut <input type="checkbox"/>	+\$0
EW	medium matte walnut <input type="checkbox"/>	+\$0
ET	clear on ash <input type="checkbox"/>	+\$0
EU	oak on ash <input type="checkbox"/>	+\$0
EV	walnut on ash <input type="checkbox"/>	+\$0
UL	natural maple <input type="checkbox"/>	+\$0
UX	walnut on cherry <input type="checkbox"/>	+\$0

Step 11. Foot Finish

For 4"-high foot (4) or 4"-high foot sleeveless (5)

8Q	folkstone grey <input type="checkbox"/>	+\$0
98	studio white <input type="checkbox"/>	+\$0
WL	sandstone <input type="checkbox"/>	+\$0
91	white <input type="checkbox"/>	+\$0
CL	cool grey neutral <input type="checkbox"/>	+\$0
G1	graphite <input type="checkbox"/>	+\$0
WN	warm grey neutral <input type="checkbox"/>	+\$0
CN	metallic champagne <input type="checkbox"/>	+\$0
EH	metallic bronze <input type="checkbox"/>	+\$0
MS	metallic silver <input type="checkbox"/>	+\$0

Step 12. Pull Finish

For arc pull (A.)

NH	brushed nickel <input type="checkbox"/>	+\$0
NK	black nickel <input type="checkbox"/>	+\$0

For bar pull (K.)

8Q	folkstone grey	+\$0
91	white	+\$0
98	studio white <input type="checkbox"/>	+\$0
G1	graphite <input type="checkbox"/>	+\$0
WL	sandstone <input type="checkbox"/>	+\$0
CN	metallic champagne <input type="checkbox"/>	+\$0
MS	metallic silver <input type="checkbox"/>	+\$0
79	green apple <input type="checkbox"/>	+\$15
MY3	yellow oxide <input type="checkbox"/>	+\$15
RO	red <input type="checkbox"/>	+\$15
TRQ	turquoise <input type="checkbox"/>	+\$15

Step 13. Lock Option

KA	keyed alike <input type="checkbox"/>	-\$10
KC	keyed differently, chrome <input type="checkbox"/>	+\$0
KD	keyed differently, black <input type="checkbox"/>	+\$0

Wood Low Credenza, with Drawers

FFC72A
FFC72K

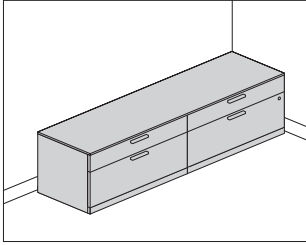

Product Information

Description

This credenza provides enclosed filing and storage and can be used freestanding or to support 1 end of a surface. It has a $\frac{3}{8}$ "-high or $\frac{1}{4}$ "-high laminate or veneer top with a laminate or veneer case. It is available with 4"-high architectural feet, 4"-high sleeveless architectural feet or a $2\frac{1}{4}$ "-high base with 1" leveling glides and has a positive interlock system that permits only 1 drawer to open at a time. Drawers have full-extension ball-bearing slides. The file drawer(s) accommodate side-to-side and front-to-back filing of letter-, legal, and A4-size hanging files.

Actual credenza widths are $29\frac{7}{8}$ ", $35\frac{7}{8}$ ", $41\frac{7}{8}$ ", $59\frac{3}{4}$ ", or $71\frac{3}{4}$ "; actual depth is $19\frac{7}{8}$ ".

Notes

For additional product options, see Vary Easy Program in Appendices. Arc pull option (A.) conforms to guidelines of Americans with Disabilities Act (ADA).

Grain direction is vertical on veneer and wood-grain laminate fronts. 30", 36", and 42"-wide credenzas have 1 box drawer and 1 file drawer.

60"- and 72"-wide credenzas have 2 box drawers and 2 file drawers.

Credenza with 4"-high foot option (4) and $\frac{3}{8}$ " thin top can be used to support a Canvas wall-based frame. Order support bracket, low credenza-to-frame (FT292.) separately.

When using credenza to support 1 end of a surface, order 1 of the following products separately:

- Surface support, low credenza, adjustable height (FT299.)
- Surface support, low credenza, fixed height (FT298.)

$\frac{1}{4}$ " top (06 and 07) is not removable and cannot be used to support a Canvas wall-based frame. The $\frac{1}{4}$ " top will add $\frac{5}{8}$ " to overall height of unit.

Please note that on the 4" sleeveless architectural foot (5) glides will be more visible.

To cover adjacent credenzas with a single top, specify credenzas with no top option (NT) and order credenza top (FF890.) separately.

To provide temporary guest seating on a credenza, order cushion top (FF891.) separately.

For keyed-alike locks, see Keyed-Alike Information in Appendices.

Dimensions

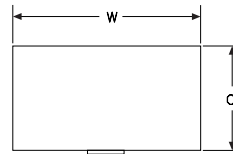

30", 36", 42" Wide

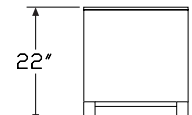
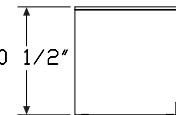
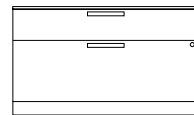

60", 72" Wide

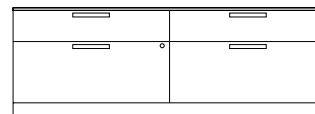

30", 36"

Wood Low Credenza, with Drawers *continued*

Specification Information	
Step 1.	
FFC72	<input type="checkbox"/> A
Step 2. Pull Type	
A.	arc pull <input type="checkbox"/> A
K.	bar pull <input type="checkbox"/> A
Step 3. Width	
30	30" wide <input type="checkbox"/> A
36	36" wide <input type="checkbox"/> A
42	42" wide <input type="checkbox"/> A
60	60" wide <input type="checkbox"/> A
72	72" wide <input type="checkbox"/> A
Step 4. Depth	
20	20" deep <input type="checkbox"/> A
Step 5. Base/Foot Height	
2	2 1/4"-high base <input type="checkbox"/> A
4	4"-high foot <input type="checkbox"/> A
5	4" -high foot sleeveless <input type="checkbox"/> A
Step 6. Configuration	
BF	box/file <input type="checkbox"/> A
Step 7. Case/Front Material	
<i>For 2 1/4"-high base (2)</i>	
L	lamine case/front <input type="checkbox"/> A
C	lamine case/veneer front <input type="checkbox"/> A
W	veneer case/front <input type="checkbox"/> A
<i>For 4"-high foot (4) or 4" -high foot sleeveless (5)</i>	
L	lamine case/front <input type="checkbox"/> A
C	lamine case/veneer front <input type="checkbox"/> A
Step 8. Top	
<i>For laminate case/front (L) or laminate case/veneer front (C)</i>	
NT	no top <input type="checkbox"/> A
03	3/8" laminate top <input type="checkbox"/> A
04	3/8" veneer top <input type="checkbox"/> A
06	1 1/4" laminate top <input type="checkbox"/> A
07	1 1/4" veneer top <input type="checkbox"/> A

<i>For veneer case/front (W)</i>							
NT	no top <input type="checkbox"/> A						
04	3/8" veneer top <input type="checkbox"/> A						
07	1 1/4" veneer top <input type="checkbox"/> A						
Prices for Steps 1-8.							
		2BFLNT	2BFL03	2BFL04	2BFL06	2BFL07	2BFCNT
FFC72A.	30 20	\$2020	2129	2349	2023	2242	2445
	36 20	\$2294	2404	2624	2298	2518	2775
	42 20	\$2596	2707	2926	2600	2820	3137
	60 20	\$3965	4129	4404	3917	4192	4790
	72 20	\$4553	4662	4881	4450	4669	5375
		2BFC03	2BFC04	2BFC06	2BFC07	2BFWNT	2BFW04
FFC72A.	30 20	\$2556	2775	2450	2669	2992	3321
	36 20	\$2884	3104	2778	2998	3420	3749
	42 20	\$3247	3466	3141	3360	3890	4220
	60 20	\$4956	5229	4743	5017	5924	6308
	72 20	\$5595	5924	5383	5711	6681	7122
		2BFW07	4BFLNT	4BFL03	4BFL04	4BFL06	4BFL07
FFC72A.	30 20	\$3215	2102	2212	2431	2106	2325
	36 20	\$3643	2377	2487	2707	2381	2600
	42 20	\$4114	2678	2788	3007	2682	2901
	60 20	\$6096	4101	4266	4542	4054	4329
	72 20	\$6910	4689	4799	5018	4586	4806
		4BFCNT	4BFC03	4BFC04	4BFC06	4BFC07	5BFLNT
FFC72A.	30 20	\$2525	2635	2854	2529	2748	2048
	36 20	\$2854	2964	3183	2858	3077	2241
	42 20	\$3217	3328	3547	3222	3441	2626
	60 20	\$4923	5087	5363	4875	5149	4049
	72 20	\$5507	5727	6056	5515	5844	4636
		5BFL03	5BFL04	5BFL06	5BFL07	5BFCNT	5BFC03
FFC72A.	30 20	\$2158	2052	2052	2273	2471	2582
	36 20	\$2351	2570	2244	2464	2802	2912
	42 20	\$2735	2954	2629	2848	3164	3274
	60 20	\$4213	4487	4001	4275	4870	5034
	72 20	\$4747	4966	4533	4754	5454	5675
		5BFC04	5BFC06	5BFC07			
FFC72A.	30 20	\$2802	2476	2696			
	36 20	\$3131	2805	3025			
	42 20	\$3493	3168	3387			
	60 20	\$5310	4822	5097			
	72 20	\$6003	5463	5791			

Wood Low Credenza, with
Drawers *continued*

		2BFLNT	2BFL03	2BFL04	2BFL06	2BFL07	2BFCNT
FFC72K.	30 20	\$2020	2129	2349	2023	2242	2445
	36 20	\$2294	2404	2624	2298	2518	2775
	42 20	\$2596	2707	2926	2600	2820	3137
	60 20	\$3965	4129	4404	3917	4192	4790
	72 20	\$4553	4662	4881	4450	4669	5375

		2BFC03	2BFC04	2BFC06	2BFC07	2BFWNT	2BFW04
FFC72K.	30 20	\$2556	2775	2450	2669	2992	3321
	36 20	\$2884	3104	2778	2998	3420	3749
	42 20	\$3247	3466	3141	3360	3890	4220
	60 20	\$4956	5229	4743	5017	5924	6308
	72 20	\$5595	5924	5383	5711	6681	7122

		2BFW07	4BFLNT	4BFL03	4BFL04	4BFL06	4BFL07
FFC72K.	30 20	\$3215	2102	2212	2431	2106	2325
	36 20	\$3643	2377	2487	2707	2381	2600
	42 20	\$4114	2678	2788	3007	2682	2901
	60 20	\$6096	4101	4266	4542	4054	4329
	72 20	\$6910	4689	4799	5018	4586	4806

		4BFCNT	4BFC03	4BFC04	4BFC06	4BFC07	5BFLNT
FFC72K.	30 20	\$2525	2635	2854	2529	2748	2048
	36 20	\$2854	2964	3183	2858	3077	2241
	42 20	\$3217	3328	3547	3222	3441	2626
	60 20	\$4923	5087	5363	4875	5149	4049
	72 20	\$5507	5727	6056	5515	5844	4636

		5BFL03	5BFL04	5BFL06	5BFL07	5BFCNT	5BFC03
FFC72K.	30 20	\$2158	2052	2052	2273	2471	2582
	36 20	\$2351	2570	2244	2464	2802	2912
	42 20	\$2735	2954	2629	2848	3164	3274
	60 20	\$4213	4487	4001	4275	4870	4902
	72 20	\$4747	4966	4533	4754	5454	5675

		5BFC04	5BFC06	5BFC07
FFC72K.	30 20	\$2802	2476	2696
	36 20	\$3131	2805	3025
	42 20	\$3493	3168	3387
	60 20	\$5177	4822	5097
	72 20	\$6003	5463	5791

Step 9. Case Finish

For 30" wide (30), 36" wide (36), 42" wide (42), or 60" wide (60) with laminate case/front (L), or laminate case/veneer front (C)

LBM	crisp linen	A	+\$0
LBN	classic linen	A	+\$0
LBP	casual linen	A	+\$0

For 30" wide (30), 36" wide (36), 42" wide (42), or 60" wide (60) with laminate case/front (L), or laminate case/veneer front (C)

LBK	pewter mesh	A	+\$0
LBL	steel mesh	A	+\$0

Solid-Color Laminate

For 30" wide (30), 36" wide (36), 42" wide (42), or 60" wide (60) with laminate case/front (L), or laminate case/veneer front (C)

8Q	folkstone grey	A	+\$0
91	white	A	+\$0
98	studio white	A	+\$0
CL	cool grey neutral	A	+\$0
LU	soft white	A	+\$0
WL	sandstone	A	+\$0
WN	warm grey neutral	A	+\$0

For 30" wide (30), 36" wide (36), 42" wide (42), or 60" wide (60) with laminate case/front (L), or laminate case/veneer front (C)

LBF	neutral twill	A	+\$0
LBG	sarum twill	A	+\$0
LBH	earthen twill	A	+\$0
LBJ	graphite twill	A	+\$0
LBQ	white twill	A	+\$0

Wood Low Credenza, with Drawers *continued*

Wood-Grain Laminate

For 30" wide (30), 36" wide (36), 42" wide (42), or 60" wide (60) with laminate case/front (L), or laminate case/veneer front (C)

LA	light ash <input type="checkbox"/>	+\$0
LBC	walnut on ash <input type="checkbox"/>	+\$0
LBE	medium red walnut <input type="checkbox"/>	+\$0
HM	natural maple <input type="checkbox"/>	+\$0
HP	light anigre <input type="checkbox"/>	+\$0
LBA	clear on ash <input type="checkbox"/>	+\$0
LBR	phantom ecru <input type="checkbox"/>	+\$0
LBS	phantom cocoa <input type="checkbox"/>	+\$0
LBU	medium matte walnut <input type="checkbox"/>	+\$0
LBV	warm grey teak <input type="checkbox"/>	+\$0
LBB	oak on ash <input type="checkbox"/>	+\$0
LBD	dark brown walnut <input type="checkbox"/>	+\$0
76	light brown walnut <input type="checkbox"/>	+\$0
HX	aged cherry <input type="checkbox"/>	+\$0
HY	walnut on cherry <input type="checkbox"/>	+\$0

For 72" wide (72) with laminate case/front (L), or laminate case/veneer front (C)

LBM	crisp linen <input type="checkbox"/>	+\$0
LBN	classic linen <input type="checkbox"/>	+\$0
LBP	casual linen <input type="checkbox"/>	+\$0

For 72" wide (72) with laminate case/front (L), or laminate case/veneer front (C)

LBK	pewter mesh <input type="checkbox"/>	+\$0
LBL	steel mesh <input type="checkbox"/>	+\$0

Solid-Color Laminate

For 72" wide (72) with laminate case/front (L), or laminate case/veneer front (C)

8Q	folkstone grey <input type="checkbox"/>	+\$0
91	white <input type="checkbox"/>	+\$0
98	studio white <input type="checkbox"/>	+\$0
CL	cool grey neutral <input type="checkbox"/>	+\$0
LU	soft white <input type="checkbox"/>	+\$0
WL	sandstone <input type="checkbox"/>	+\$0
WN	warm grey neutral <input type="checkbox"/>	+\$0

Wood Veneer

For veneer case/front (W)

2U	light brown walnut <input type="checkbox"/>	+\$0
40	dark brown walnut <input type="checkbox"/>	+\$0
ED	aged cherry <input type="checkbox"/>	+\$0
EK	medium red walnut <input type="checkbox"/>	+\$0
EW	medium matte walnut <input type="checkbox"/>	+\$0
ET	clear on ash <input type="checkbox"/>	+\$0
EU	oak on ash <input type="checkbox"/>	+\$0
EV	walnut on ash <input type="checkbox"/>	+\$0
UL	natural maple <input type="checkbox"/>	+\$0
UX	walnut on cherry <input type="checkbox"/>	+\$0

Step 10. Front Finish

For laminate case/front (L)

LBM	crisp linen <input type="checkbox"/>	+\$0
LBN	classic linen <input type="checkbox"/>	+\$0
LBP	casual linen <input type="checkbox"/>	+\$0

For laminate case/front (L)

LBK	pewter mesh <input type="checkbox"/>	+\$0
LBL	steel mesh <input type="checkbox"/>	+\$0

Solid-Color Laminate

For laminate case/front (L)

8Q	folkstone grey <input type="checkbox"/>	+\$0
91	white <input type="checkbox"/>	+\$0
98	studio white <input type="checkbox"/>	+\$0
CL	cool grey neutral <input type="checkbox"/>	+\$0
LU	soft white <input type="checkbox"/>	+\$0
WL	sandstone <input type="checkbox"/>	+\$0
WN	warm grey neutral <input type="checkbox"/>	+\$0

For laminate case/front (L)

LBF	neutral twill <input type="checkbox"/>	+\$0
LBG	sarum twill <input type="checkbox"/>	+\$0
LBH	earthen twill <input type="checkbox"/>	+\$0
LBJ	graphite twill <input type="checkbox"/>	+\$0
LBQ	white twill <input type="checkbox"/>	+\$0

Wood Low Credenza, with Drawers *continued*

Wood-Grain Laminate

For laminate case/front (L)

LA	light ash <input type="checkbox"/>	+\$0
LBC	walnut on ash <input type="checkbox"/>	+\$0
LBE	medium red walnut <input type="checkbox"/>	+\$0
HM	natural maple <input type="checkbox"/>	+\$0
HP	light anigre <input type="checkbox"/>	+\$0
LBA	clear on ash <input type="checkbox"/>	+\$0
LBR	phantom ecru <input type="checkbox"/>	+\$0
LBS	phantom cocoa <input type="checkbox"/>	+\$0
LBU	medium matte walnut <input type="checkbox"/>	+\$0
LBV	warm grey teak <input type="checkbox"/>	+\$0
LBB	oak on ash <input type="checkbox"/>	+\$0
LBD	dark brown walnut <input type="checkbox"/>	+\$0
76	light brown walnut <input type="checkbox"/>	+\$0
HX	aged cherry <input type="checkbox"/>	+\$0
HY	walnut on cherry <input type="checkbox"/>	+\$0

Wood Veneer

For laminate case/veneer front (C) or veneer case/front (W)

2U	light brown walnut <input type="checkbox"/>	+\$0
40	dark brown walnut <input type="checkbox"/>	+\$0
ED	aged cherry <input type="checkbox"/>	+\$0
EK	medium red walnut <input type="checkbox"/>	+\$0
EW	medium matte walnut <input type="checkbox"/>	+\$0
ET	clear on ash <input type="checkbox"/>	+\$0
EU	oak on ash <input type="checkbox"/>	+\$0
EV	walnut on ash <input type="checkbox"/>	+\$0
UL	natural maple <input type="checkbox"/>	+\$0
UX	walnut on cherry <input type="checkbox"/>	+\$0

Step 11. Top Finish

For 3/8" laminate top (03) or 1 1/4" laminate top (06)

LBM	crisp linen <input type="checkbox"/>	+\$0
LBN	classic linen <input type="checkbox"/>	+\$0
LBP	casual linen <input type="checkbox"/>	+\$0

For 3/8" laminate top (03) or 1 1/4" laminate top (06)

LBK	pewter mesh <input type="checkbox"/>	+\$0
LBL	steel mesh <input type="checkbox"/>	+\$0

Solid-Color Laminate

For 3/8" laminate top (03) or 1 1/4" laminate top (06)

8Q	folkstone grey <input type="checkbox"/>	+\$0
91	white <input type="checkbox"/>	+\$0
98	studio white <input type="checkbox"/>	+\$0
CL	cool grey neutral <input type="checkbox"/>	+\$0
LU	soft white <input type="checkbox"/>	+\$0
WL	sandstone <input type="checkbox"/>	+\$0
WN	warm grey neutral <input type="checkbox"/>	+\$0

For 3/8" laminate top (03) or 1 1/4" laminate top (06)

LBF	neutral twill <input type="checkbox"/>	+\$0
LBG	sarum twill <input type="checkbox"/>	+\$0
LBH	earthen twill <input type="checkbox"/>	+\$0
LBJ	graphite twill <input type="checkbox"/>	+\$0
LBQ	white twill <input type="checkbox"/>	+\$0

Wood-Grain Laminate

For 3/8" laminate top (03) or 1 1/4" laminate top (06)

LBC	walnut on ash <input type="checkbox"/>	+\$0
LBE	medium red walnut <input type="checkbox"/>	+\$0
HM	natural maple <input type="checkbox"/>	+\$0
HP	light anigre <input type="checkbox"/>	+\$0
LBA	clear on ash <input type="checkbox"/>	+\$0
LBR	phantom ecru <input type="checkbox"/>	+\$0
LBS	phantom cocoa <input type="checkbox"/>	+\$0
LBU	medium matte walnut <input type="checkbox"/>	+\$0
LBV	warm grey teak <input type="checkbox"/>	+\$0
LBB	oak on ash <input type="checkbox"/>	+\$0
LBD	dark brown walnut <input type="checkbox"/>	+\$0
76	light brown walnut <input type="checkbox"/>	+\$0
HX	aged cherry <input type="checkbox"/>	+\$0
HY	walnut on cherry <input type="checkbox"/>	+\$0

Wood Veneer

For 3/8" veneer top (04) or 1 1/4" veneer top (07)

2U	light brown walnut <input type="checkbox"/>	+\$0
40	dark brown walnut <input type="checkbox"/>	+\$0
ED	aged cherry <input type="checkbox"/>	+\$0
EK	medium red walnut <input type="checkbox"/>	+\$0
EW	medium matte walnut <input type="checkbox"/>	+\$0
ET	clear on ash <input type="checkbox"/>	+\$0
EU	oak on ash <input type="checkbox"/>	+\$0
EV	walnut on ash <input type="checkbox"/>	+\$0
UL	natural maple <input type="checkbox"/>	+\$0
UX	walnut on cherry <input type="checkbox"/>	+\$0

Wood Low Credenza, with Drawers *continued*

Step 12. Foot Finish

For 4"-high foot (4) or 4"-high foot sleeveless (5)

8Q	folkstone grey <input type="checkbox"/>	+\$0
98	studio white <input type="checkbox"/>	+\$0
WL	sandstone <input type="checkbox"/>	+\$0
91	white <input type="checkbox"/>	+\$0
CL	cool grey neutral <input type="checkbox"/>	+\$0
G1	graphite <input type="checkbox"/>	+\$0
WN	warm grey neutral <input type="checkbox"/>	+\$0
CN	metallic champagne <input type="checkbox"/>	+\$0
EH	metallic bronze <input type="checkbox"/>	+\$0
MS	metallic silver <input type="checkbox"/>	+\$0

Step 13. Pull Finish

For arc pull (A.)

NH	brushed nickel <input type="checkbox"/>	+\$0
NK	black nickel <input type="checkbox"/>	+\$0

For bar pull (K.)

G1	graphite <input type="checkbox"/>	+\$0
8Q	folkstone grey	+\$0
91	white	+\$0
98	studio white <input type="checkbox"/>	+\$0
WL	sandstone <input type="checkbox"/>	+\$0
CN	metallic champagne <input type="checkbox"/>	+\$0
MS	metallic silver <input type="checkbox"/>	+\$0
79	green apple <input type="checkbox"/>	+\$15
MY3	yellow oxide <input type="checkbox"/>	+\$15
RO	red <input type="checkbox"/>	+\$15
TRQ	turquoise <input type="checkbox"/>	+\$15

Step 14. Counterweight

NO	no counterweight <input type="checkbox"/>	+\$0
CB	counterweight <input type="checkbox"/>	+\$70

Step 15. Lock Option

KA	keyed alike <input type="checkbox"/>	-\$10
KC	keyed differently, chrome <input type="checkbox"/>	+\$0
KD	keyed differently, black <input type="checkbox"/>	+\$0

Wood Low Credenza, Open with Drawers

FFC73A
FFC73K

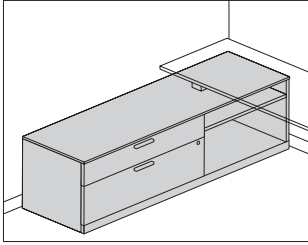

Product Information

Description

This credenza provides drawer storage on 1 side with open storage on the other side and can be used freestanding or to support 1 end of a surface. It has a $\frac{3}{8}$ "-high or $\frac{1}{4}$ "-high laminate or veneer top with a laminate or veneer case. It is available with 4"-high architectural feet, 4"-high sleeveless architectural feet or a $2\frac{1}{4}$ "-high base with 1" leveling glides and has a positive interlock system that permits only 1 drawer to open at a time. Drawers have full-extension ball-bearing slides. The file drawer accommodates side-to-side and front-to-back filing of letter-, legal, and A4-size hanging files.

Actual credenza widths are $47\frac{3}{4}$ ", $59\frac{3}{4}$ " or $71\frac{3}{4}$ "; actual depth is $19\frac{7}{8}$ ".

Notes

For additional product options, see Vary Easy Program in Appendices.

Arc pull option (A.) conforms to guidelines of Americans with Disabilities Act (ADA).

Grain direction is vertical on veneer and wood-grain laminate fronts. Open side of Credenza includes 1 adjustable shelf that adjusts in $\frac{1}{4}$ " increments.

Credenza with 4"-high foot option (4) and $\frac{3}{8}$ " thin top can be used to support a Canvas wall-based frame. Order support bracket, low credenza-to-frame (FT292.) separately.

When using credenza to support 1 end of a surface, order 1 of the following products separately:

- Surface support, low credenza, adjustable height (FT299.)
- Surface support, low credenza, fixed height (FT298.)

To cover adjacent credenzas with a single top, specify credenzas with no top option (NT) and order credenza top (FF890.) separately.

$\frac{1}{4}$ " top (o6 and o7) is not removable and cannot be used to support a Canvas wall-based frame. The $\frac{1}{4}$ " top will add $\frac{5}{8}$ " to overall height of unit.

Please note that on the 4" sleeveless architectural foot (5) glides will be more visible.

Order optional wood credenza shelf (FF892.) separately.

To provide temporary guest seating on a credenza, order cushion top (FF891.) separately.

For keyed-alike locks, see Keyed-Alike Information in Appendices.

Dimensions

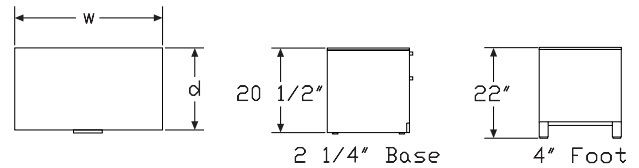

48" Wide

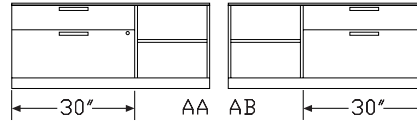

60" Wide

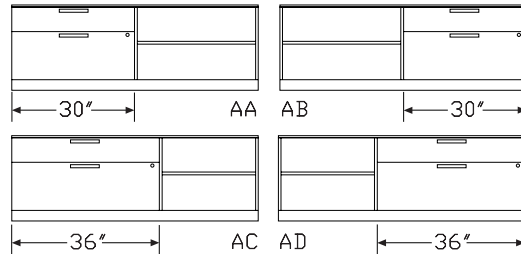

66" Wide

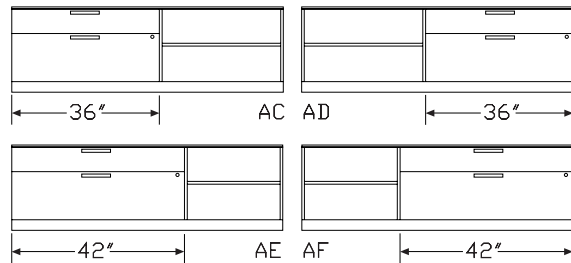

72" Wide

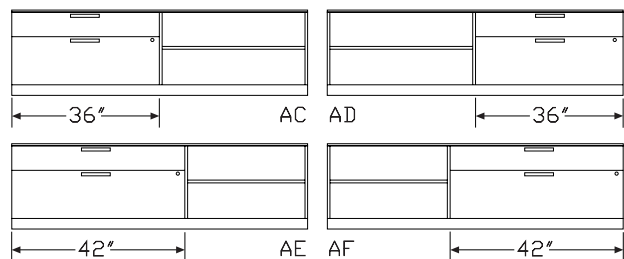

Wood Low Credenza, Open with Drawers *continued*

Specification Information

Step 1.

FFC73

Step 2. Pull Type

- A.** arc pull
- K.** bar pull

Step 3. Width

- 48** 48" wide
- 60** 60" wide
- 66** 66" wide
- 72** 72" wide

Step 4. Depth

- 20** 20" deep

Step 5. Base/Foot Height

- 2** 2¹/₄"-high base
- 4** 4"-high foot
- 5** 4"-high foot sleeveless

Step 6. Configuration

For 48" wide (48)

- AA** 30" box/file left, open right
- AB** open left, 30" box/file right

For 60" wide (60)

- AA** 30" box/file left, open right
- AB** open left, 30" box/file right
- AC** 36" box/file left, open right
- AD** open left, 36" box/file right

For 66" wide (66)

- AC** 36" box/file left, open right
- AD** open left, 36" box/file right
- AE** 42" box/file left, open right
- AF** open left, 42" box/file right

For 72" wide (72)

- AC** 36" box/file left, open right
- AD** open left, 36" box/file right
- AE** 42" box/file left, open right
- AF** open left, 42" box/file right

Step 7. Case/Front Material

For 2¹/₄"-high base (2)

- L** laminate case/front
- C** laminate case/veneer front
- W** veneer case/front

For 4"-high foot (4) or 4"-high foot sleeveless (5)

- L** laminate case/front
- C** laminate case/veneer front

Step 8. Top

For laminate case/front (L) or laminate case/veneer front (C)

- NT** no top
- 03** 3/8" laminate top
- 04** 3/8" veneer top
- 06** 1¹/₄" laminate top
- 07** 1¹/₄" veneer top

For veneer case/front (W)

- NT** no top
- 04** 3/8" veneer top
- 07** 1¹/₄" veneer top

Prices for Steps 1-8.

		2AALNT	2AAL03	2AAL04	2AAL06	2AAL07	2AACNT
FFC73A.	48 20	\$2671	2809	3055	2596	2843	3091
	60 20	\$2934	3099	3374	2887	3161	3399
		2AAC03	2AAC04	2AAC06	2AAC07	2AAWNT	2AAW04
FFC73A.	48 20	\$3229	3476	3017	3263	4163	4519
	60 20	\$3563	3839	3351	3627	4604	4987
		2AAW07	2ABLNT	2ABL03	2ABL04	2ABL06	2ABL07
FFC73A.	48 20	\$4413	2671	2809	3055	2596	2843
	60 20	\$4775	2934	3099	3374	2887	3161
		2ABCNT	2ABC03	2ABC04	2ABC06	2ABC07	2ABWNT
FFC73A.	48 20	\$3091	3229	3476	3017	3263	4163
	60 20	\$3399	3563	3839	3351	3627	4604
		2ABW04	2ABW07	2ACLNT	2ACL03	2ACL04	2ACL06
FFC73A.	48 20	\$4519	4413	—	—	—	—
	60 20	\$4987	4775	3018	3181	3456	2969
	66 20	—	—	\$3124	3287	3562	3075
	72 20	—	—	\$3135	3359	3697	3147

Wood Low Credenza, Open with Drawers *continued*

		2ACL07	2ACCNT	2ACC03	2ACC04	2ACC06	2ACC07
FFC73A.	60 20	\$3244	3493	3658	3934	3446	3721
	66 20	\$3350	3617	3781	4056	3568	3844
	72 20	\$3485	3638	3863	4200	3651	3988
		2ACWNT	2ACW04	2ACW07	2AELNT	2AEL03	2AEL04
FFC73A.	60 20	\$4735	5121	4909	—	—	—
	66 20	\$4908	5292	5080	3206	3371	3646
	72 20	\$5014	5408	5195	3252	3478	3815
		2AEL06	2AEL07	2AECNT	2AEC03	2AEC04	2AEC06
FFC73A.	66 20	\$3158	3434	3711	3875	4151	3663
	72 20	\$3266	3602	3774	4000	4338	3788
		2AEC07	2AEWNT	2AEW04	2AEW07	2ADLNT	2ADL03
FFC73A.	60 20	—	—	—	—	\$3018	3181
	66 20	\$3939	5040	5425	5213	3124	3287
	72 20	\$4125	5205	5598	5386	3135	3359
		2ADL04	2ADL06	2ADL07	2ADCNT	2ADC03	2ADC04
FFC73A.	60 20	\$3456	2969	3244	3493	3658	3934
	66 20	\$3562	3075	3350	3617	3781	4056
	72 20	\$3697	3147	3485	3638	3863	4200
		2ADC06	2ADC07	2ADWNT	2ADW04	2ADW07	2AFLNT
FFC73A.	60 20	\$3446	3721	4735	5121	4909	—
	66 20	\$3568	3844	4908	5292	5080	3206
	72 20	\$3651	3988	5014	5408	5290	3252
		2AFL03	2AFL04	2AFL06	2AFL07	2AFCNT	2AFC03
FFC73A.	66 20	\$3371	3646	3158	3434	3711	3875
	72 20	\$3478	3815	3266	3602	3774	4000
		2AFC04	2AFC06	2AFC07	2AFWNT	2AFW04	2AFW07
FFC73A.	66 20	\$4151	3663	3939	5040	5425	5213
	72 20	\$4338	3788	4125	5205	5598	5386
		4AALNT	4AAL03	4AAL04	4AAL06	4AAL07	4AACNT
FFC73A.	48 20	\$2809	2945	3192	2733	2980	3225
	60 20	\$3071	3237	3511	3025	3299	3532
		4AAC03	4AAC04	4AAC06	4AAC07	4ABLNT	4ABL03
FFC73A.	48 20	\$3360	3608	3148	3395	2809	2945
	60 20	\$3696	3971	3484	3759	3071	3237
		4ABL04	4ABL06	4ABL07	4ABCNT	4ABC03	4ABC04
FFC73A.	48 20	\$3192	2733	2980	3225	3360	3608

	60 20	\$3511	3025	3299	3532	3696	3971
		4ABC06	4ABC07	4ACLNT	4ACLO3	4ACLO4	4ACLO6
FFC73A.	48 20	\$3148	3395	—	—	—	—
	60 20	\$3484	3759	3154	3319	3593	3106
	66 20	—	—	\$3260	3426	3699	3213
	72 20	—	—	\$3275	3499	3838	3287
		4ACL07	4ACCNT	4ACC03	4ACC04	4ACC06	4ACC07
FFC73A.	60 20	\$3381	3627	3791	4065	3579	3853
	66 20	\$3487	3749	3913	4189	3701	3976
	72 20	\$3626	3770	3995	4333	3783	4120
		4AELNT	4AEL03	4AEL04	4AEL06	4AEL07	4AECNT
FFC73A.	66 20	\$3343	3508	3782	3295	3569	3844
	72 20	\$3392	3618	3955	3406	3743	3907
		4AEC03	4AEC04	4AEC06	4AEC07	4ADLNT	4ADL03
FFC73A.	60 20	—	—	—	—	\$3154	3319
	66 20	\$4008	4283	3796	4071	3260	3426
	72 20	\$4133	4470	3920	4258	3275	3499
		4ADL04	4ADL06	4ADL07	4ADCNT	4ADC03	4ADC04
FFC73A.	60 20	\$3593	3106	3381	3627	3791	4065
	66 20	\$3699	3213	3487	3749	3913	4189
	72 20	\$3838	3287	3626	3770	3995	4333
		4ADC06	4ADC07	4AFLNT	4AFL03	4AFL04	4AFL06
FFC73A.	60 20	\$3579	3853	—	—	—	—
	66 20	\$3701	3976	3343	3508	3782	3295
	72 20	\$3783	4120	3392	3618	3955	3406
		4AFL07	4AFCNT	4AFC03	4AFC04	4AFC06	4AFC07
FFC73A.	66 20	\$3569	3844	4008	4283	3796	4071
	72 20	\$3743	3907	4133	4470	3920	4258
		5AALNT	5AAL03	5AAL04	5AAL06	5AAL07	5AACNT
FFC73A.	48 20	\$2754	2892	3139	2679	2927	3171
	60 20	\$3019	3183	3457	2971	3245	3479
		5AAC03	5AAC04	5AAC06	5AAC07	5ABLNT	5ABL03
FFC73A.	48 20	\$3308	3555	3096	3343	2754	2892
	60 20	\$3643	3918	3431	3705	3019	3183
		5ABL04	5ABL06	5ABL07	5ABCNT	5ABC03	5ABC04
FFC73A.	48 20	\$3139	2679	2927	3171	3308	3555
	60 20	\$3457	2971	3245	3479	3643	3918

Canvas Office Landscape® Wood Case Credenzas

Wood Low Credenza, Open with Drawers *continued*

Canvas Office Landscape® Wood Case Credenzas

		5ABC06	5ABC07	5ACLNT	5ACL03	5ACL04	5ACL06
FFC73A.	48 20	\$3096	3343	—	—	—	—
	60 20	\$3431	3705	3101	3266	3541	3053
	66 20	—	—	\$3207	3373	3647	3160
	72 20	—	—	\$3223	3447	3784	3235

		5ACL07	5ACCNT	5ACC03	5ACC04	5ACC06	5ACC07
FFC73A.	60 20	\$3329	3573	3738	4012	3526	3800
	66 20	\$3435	3696	3861	4136	3649	3923
	72 20	\$3572	3718	3943	4279	3731	4067

		5AELNT	5AEL03	5AEL04	5AEL06	5AEL07	5AECNT
FFC73A.	66 20	\$3289	3454	3730	3242	3517	3791
	72 20	\$3340	3564	3902	3352	3690	3854

		5AEC03	5AEC04	5AEC06	5AEC07	5ADLNT	5ADL03
FFC73A.	60 20	—	—	—	—	\$3101	3266
	66 20	\$3955	4230	3743	4017	3207	3373
	72 20	\$4079	4416	3867	4204	3223	3447

		5ADL04	5ADL06	5ADL07	5ADCNT	5ADC03	5ADC04
FFC73A.	60 20	\$3541	3053	3329	3573	3738	4012
	66 20	\$3647	3160	3435	3696	3861	4136
	72 20	\$3784	3235	3572	3718	3943	4279

		5ADC06	5ADC07	5AFLNT	5AFL03	5AFL04	5AFL06
FFC73A.	60 20	\$3526	3800	—	—	—	—
	66 20	\$3649	3923	3289	3454	3730	3242
	72 20	\$3731	4067	3340	3564	3902	3352

		5AFL07	5AFCNT	5AFC03	5AFC04	5AFC06	5AFC07
FFC73A.	66 20	\$3517	3791	3955	4230	3743	4017
	72 20	\$3690	3854	4079	4416	3867	4204

		2AALNT	2AAL03	2AAL04	2AAL06	2AAL07	2AACNT
FFC73K.	48 20	\$2671	2809	3055	2596	2843	3091
	60 20	\$2934	3099	3374	2887	3161	3399

		2AAC03	2AAC04	2AAC06	2AAC07	2AAWNT	2AAW04
FFC73K.	48 20	\$3360	3608	3017	3263	4163	4519
	60 20	\$3563	3839	3351	3627	4604	4987

		2AAW07	2ABLNT	2ABL03	2ABL04	2ABL06	2ABL07
FFC73K.	48 20	\$4413	2671	2809	3055	2596	2843
	60 20	\$4775	2934	3099	3374	2887	3161

		2ABCNT	2ABC03	2ABC04	2ABC06	2ABC07	2ABWNT
FFC73K.	48 20	\$3091	3229	3476	3017	3263	4163
	60 20	\$3399	3563	3839	3351	3627	4604

		2ABW04	2ABW07	2ACLNT	2ACL03	2ACL04	2ACL06
FFC73K.	48 20	\$4519	4413	—	—	—	—
	60 20	\$4987	4775	3018	3181	3456	2969
	66 20	—	—	\$3313	3287	3562	3075
	72 20	—	—	\$3135	3359	3697	3147

		2ACL07	2ACCNT	2ACC03	2ACC04	2ACC06	2ACC07
FFC73K.	60 20	\$3244	3493	3658	3934	3446	3721
	66 20	\$3350	3616	3781	4055	3568	3844
	72 20	\$3485	3638	3863	4200	3651	3988

		2ACWNT	2ACW04	2ACW07	2AELNT	2AEL03	2AEL04
FFC73K.	60 20	\$4735	5121	4909	—	—	—
	66 20	\$4908	5291	5080	3206	3371	3646
	72 20	\$5014	5408	5195	3252	3478	3815

		2AEL06	2AEL07	2AECNT	2AEC03	2AEC04	2AEC06
FFC73K.	66 20	\$3158	3434	3711	3875	4151	3663
	72 20	\$3266	3602	3774	4000	4338	3788

		2AEC07	2AEWNT	2AEW04	2AEW07	2ADLNT	2ADL03
FFC73K.	60 20	—	—	—	—	\$3018	3181
	66 20	\$3939	5040	5425	5213	3123	3287
	72 20	\$4125	5205	5598	5386	3135	3359

		2ADL04	2ADL06	2ADL07	2ADCNT	2ADC03	2ADC04
FFC73K.	60 20	\$3456	2969	3244	3493	3658	3934
	66 20	\$3863	3075	3350	3616	3781	4055
	72 20	\$3697	3147	3485	3638	3863	4200

		2ADC06	2ADC07	2ADWNT	2ADW04	2ADW07	2AFLNT
FFC73K.	60 20	\$3446	3721	4735	5121	4909	—
	66 20	\$3568	3844	4908	5291	5080	3206
	72 20	\$3651	3988	5014	5408	5290	3252

		2AFL03	2AFL04	2AFL06	2AFL07	2AFCNT	2AFC03
FFC73K.	66 20	\$3371	3646	3158	3434	3711	3875
	72 20	\$3478	3815	3266	3602	3774	4000

		2AFC04	2AFC06	2AFC07	2AFWNT	2AFW04	2AFW07
FFC73K.	66 20	\$4151	3663	3939	5040	5425	5213
	72 20	\$4338	3788	4125	5205	5598	5386

Wood Low Credenza, Open with
Drawers *continued*

		4AALNT	4AAL03	4AAL04	4AAL06	4AAL07	4AACNT
FFC73K.	48 20	\$2809	2945	3192	2733	2980	3225
	60 20	\$3071	3237	3511	3025	3299	3532

		4AAC03	4AAC04	4AAC06	4AAC07	4ABLNT	4ABL03
FFC73K.	48 20	\$3360	3608	3148	3395	2809	2945
	60 20	\$3696	3971	3484	3759	3071	3237

		4ABL04	4ABL06	4ABL07	4ABCNT	4ABC03	4ABC04
FFC73K.	48 20	\$3192	2733	2980	3225	3360	3608
	60 20	\$3511	3025	3299	3532	3696	3971

		4ABC06	4ABC07	4ACLNT	4ACL03	4ACL04	4ACL06
FFC73K.	48 20	\$3148	3395	—	—	—	—
	60 20	\$3484	3759	3154	3319	3593	3106
	66 20	—	—	\$3260	3426	3699	3213
	72 20	—	—	\$3275	3499	3838	3287

		4ACL07	4ACCNT	4ACC03	4ACC04	4ACC06	4ACC07
FFC73K.	60 20	\$3381	3627	3791	4065	3579	3853
	66 20	\$3487	3749	3913	4189	3701	3976
	72 20	\$3626	3770	3995	4333	3783	4120

		4AELNT	4AEL03	4AEL04	4AEL06	4AEL07	4AECNT
FFC73K.	66 20	\$3343	3508	3782	3295	3569	3844
	72 20	\$3392	3618	3955	3406	3743	3907

		4AEC03	4AEC04	4AEC06	4AEC07	4ADLNT	4ADL03
FFC73K.	60 20	—	—	—	—	\$3154	3319
	66 20	\$4008	4283	3796	4071	3260	3426
	72 20	\$4133	4470	3920	4258	3275	3499

		4ADL04	4ADL06	4ADL07	4ADCNT	4ADC03	4ADC04
FFC73K.	60 20	\$3593	3106	3381	3627	3791	4065
	66 20	\$3699	3213	3487	3749	3913	4189
	72 20	\$3838	3287	3626	3770	3995	4333

		4ADC06	4ADC07	4AFLNT	4AFL03	4AFL04	4AFL06
FFC73K.	60 20	\$3579	3853	—	—	—	—
	66 20	\$3701	3976	3343	3508	3782	3295
	72 20	\$3783	4120	3392	3618	3955	3406

		4AFL07	4AFCNT	4AFC03	4AFC04	4AFC06	4AFC07
FFC73K.	66 20	\$3569	3844	4008	4283	3796	4071
	72 20	\$3743	3907	4133	4470	3920	4258

		5AALNT	5AAL03	5AAL04	5AAL06	5AAL07	5AACNT
FFC73K.	48 20	\$2754	2892	3139	2679	2927	3171
	60 20	\$3019	3183	3457	2971	3245	3479

		5AAC03	5AAC04	5AAC06	5AAC07	5ABLNT	5ABL03
FFC73K.	48 20	\$3308	3555	3096	3343	2754	2892
	60 20	\$3643	3918	3431	3705	3019	3183

		5ABL04	5ABL06	5ABL07	5ABCNT	5ABC03	5ABC04
FFC73K.	48 20	\$3139	2679	2927	3171	3308	3555
	60 20	\$3457	2971	3245	3479	3643	3918

		5ABC06	5ABC07	5ACLNT	5ACL03	5ACL04	5ACL06
FFC73K.	48 20	\$3096	3343	—	—	—	—
	60 20	\$3431	3705	3101	3266	3541	3053
	66 20	—	—	\$3207	3373	3647	3160
	72 20	—	—	\$3223	3447	3784	3235

		5ACL07	5ACCNT	5ACC03	5ACC04	5ACC06	5ACC07
FFC73K.	60 20	\$3329	3573	3738	4012	3526	3800
	66 20	\$3435	3696	3861	4136	3649	3923
	72 20	\$3572	3718	3943	4279	3731	4067

		5AELNT	5AEL03	5AEL04	5AEL06	5AEL07	5AECNT
FFC73K.	66 20	\$3289	3454	3730	3242	3517	3791
	72 20	\$3340	3564	3902	3352	3690	3854

		5AEC03	5AEC04	5AEC06	5AEC07	5ADLNT	5ADL03
FFC73K.	60 20	—	—	—	—	\$3101	3266
	66 20	\$3955	4230	3743	4017	3207	3373
	72 20	\$4079	4416	3867	4204	3223	3447

		5ADL04	5ADL06	5ADL07	5ADCNT	5ADC03	5ADC04
FFC73K.	60 20	\$3541	3053	3329	3573	3738	4012
	66 20	\$3647	3160	3435	3696	3861	4136
	72 20	\$3784	3235	3572	3718	3943	4279

		5ADC06	5ADC07	5AFLNT	5AFL03	5AFL04	5AFL06
FFC73K.	60 20	\$3526	3800	—	—	—	—
	66 20	\$3649	3923	3289	3454	3730	3242
	72 20	\$3731	4067	3340	3564	3902	3352

		5AFL07	5AFCNT	5AFC03	5AFC04	5AFC06	5AFC07
FFC73K.	66 20	\$3517	3791	3955	4230	3743	4017
	72 20	\$3690	3854	4079	4416	3867	4204

Canvas Office Landscape® Wood Case Credenzas

Wood Low Credenza, Open with Drawers *continued*

Step 9. Case Finish

For 48" wide (48) or 60" wide (60) with laminate case/front (L), or laminate case/veneer front (C)

LBM	crisp linen A	+\$0
LBN	classic linen A	+\$0
LBP	casual linen A	+\$0

For 48" wide (48) or 60" wide (60) with laminate case/front (L), or laminate case/veneer front (C)

LBK	pewter mesh A	+\$0
LBL	steel mesh A	+\$0

Solid-Color Laminate

For 48" wide (48) or 60" wide (60) with laminate case/front (L), or laminate case/veneer front (C)

8Q	folkstone grey A	+\$0
91	white A	+\$0
98	studio white A	+\$0
CL	cool grey neutral A	+\$0
LU	soft white A	+\$0
WL	sandstone A	+\$0
WN	warm grey neutral A	+\$0

For 48" wide (48) or 60" wide (60) with laminate case/front (L), or laminate case/veneer front (C)

LBF	neutral twill A	+\$0
LBG	sarum twill A	+\$0
LBH	earthen twill A	+\$0
LBJ	graphite twill A	+\$0
LBQ	white twill A	+\$0

Wood-Grain Laminate

For 48" wide (48) or 60" wide (60) with laminate case/front (L), or laminate case/veneer front (C)

LBC	walnut on ash A	+\$0
LBE	medium red walnut A	+\$0
HM	natural maple A	+\$0
HP	light anigre A	+\$0
LBA	clear on ash A	+\$0
LBR	phantom ecru A	+\$0
LBS	phantom cocoa A	+\$0
LBU	medium matte walnut A	+\$0
LBV	warm grey teak A	+\$0
LBB	oak on ash A	+\$0
LBD	dark brown walnut A	+\$0
76	light brown walnut A	+\$0
HX	aged cherry A	+\$0
HY	walnut on cherry A	+\$0

For 66" wide (66) or 72" wide (72) with laminate case/front (L), or laminate case/veneer front (C)

LBM	crisp linen A	+\$0
LBN	classic linen A	+\$0
LBP	casual linen A	+\$0

For 66" wide (66) or 72" wide (72) with laminate case/front (L), or laminate case/veneer front (C)

LBK	pewter mesh A	+\$0
LBL	steel mesh A	+\$0

Solid-Color Laminate

For 66" wide (66) or 72" wide (72) with laminate case/front (L), or laminate case/veneer front (C)

8Q	folkstone grey A	+\$0
91	white A	+\$0
98	studio white A	+\$0
CL	cool grey neutral A	+\$0
LU	soft white A	+\$0
WL	sandstone A	+\$0
WN	warm grey neutral A	+\$0

Wood Low Credenza, Open with Drawers *continued*

Wood Veneer

For veneer case/front (W)

2U	light brown walnut <input type="checkbox"/>	+\$0
40	dark brown walnut <input type="checkbox"/>	+\$0
ED	aged cherry <input type="checkbox"/>	+\$0
EK	medium red walnut <input type="checkbox"/>	+\$0
EW	medium matte walnut <input type="checkbox"/>	+\$0
ET	clear on ash <input type="checkbox"/>	+\$0
EU	oak on ash <input type="checkbox"/>	+\$0
EV	walnut on ash <input type="checkbox"/>	+\$0
UL	natural maple <input type="checkbox"/>	+\$0
UX	walnut on cherry <input type="checkbox"/>	+\$0

Step 10. Front Finish

For laminate case/front (L)

LBM	crisp linen <input type="checkbox"/>	+\$0
LBN	classic linen <input type="checkbox"/>	+\$0
LBP	casual linen <input type="checkbox"/>	+\$0

For laminate case/front (L)

LBK	pewter mesh <input type="checkbox"/>	+\$0
LBL	steel mesh <input type="checkbox"/>	+\$0

Solid-Color Laminate

For laminate case/front (L)

8Q	folkstone grey <input type="checkbox"/>	+\$0
91	white <input type="checkbox"/>	+\$0
98	studio white <input type="checkbox"/>	+\$0
CL	cool grey neutral <input type="checkbox"/>	+\$0
LU	soft white <input type="checkbox"/>	+\$0
WL	sandstone <input type="checkbox"/>	+\$0
WN	warm grey neutral <input type="checkbox"/>	+\$0

For laminate case/front (L)

LBF	neutral twill <input type="checkbox"/>	+\$0
LBG	sarum twill <input type="checkbox"/>	+\$0
LBH	earthen twill <input type="checkbox"/>	+\$0
LBJ	graphite twill <input type="checkbox"/>	+\$0
LBQ	white twill <input type="checkbox"/>	+\$0

Wood-Grain Laminate

For laminate case/front (L)

LBC	walnut on ash <input type="checkbox"/>	+\$0
LBE	medium red walnut <input type="checkbox"/>	+\$0
HM	natural maple <input type="checkbox"/>	+\$0
HP	light anigre <input type="checkbox"/>	+\$0
LBA	clear on ash <input type="checkbox"/>	+\$0
LBR	phantom ecru <input type="checkbox"/>	+\$0
LBS	phantom cocoa <input type="checkbox"/>	+\$0
LBU	medium matte walnut <input type="checkbox"/>	+\$0
LBV	warm grey teak <input type="checkbox"/>	+\$0
LBB	oak on ash <input type="checkbox"/>	+\$0
LBD	dark brown walnut <input type="checkbox"/>	+\$0
76	light brown walnut <input type="checkbox"/>	+\$0
HX	aged cherry <input type="checkbox"/>	+\$0
HY	walnut on cherry <input type="checkbox"/>	+\$0

Wood Veneer

For laminate case/veneer front (C) or veneer case/front (W)

2U	light brown walnut <input type="checkbox"/>	+\$0
40	dark brown walnut <input type="checkbox"/>	+\$0
ED	aged cherry <input type="checkbox"/>	+\$0
EK	medium red walnut <input type="checkbox"/>	+\$0
EW	medium matte walnut <input type="checkbox"/>	+\$0
ET	clear on ash <input type="checkbox"/>	+\$0
EU	oak on ash <input type="checkbox"/>	+\$0
EV	walnut on ash <input type="checkbox"/>	+\$0
UL	natural maple <input type="checkbox"/>	+\$0
UX	walnut on cherry <input type="checkbox"/>	+\$0

Step 11. Top Finish

For 3/8" laminate top (03) or 1 1/4" laminate top (06)

LBM	crisp linen <input type="checkbox"/>	+\$0
LBN	classic linen <input type="checkbox"/>	+\$0
LBP	casual linen <input type="checkbox"/>	+\$0

For 3/8" laminate top (03) or 1 1/4" laminate top (06)

LBK	pewter mesh <input type="checkbox"/>	+\$0
LBL	steel mesh <input type="checkbox"/>	+\$0

Wood Low Credenza, Open with Drawers *continued*

Solid-Color Laminate

For 3/8" laminate top (03) or 1/4" laminate top (06)

8Q	folkstone grey <input type="checkbox"/>	+\$0
91	white <input type="checkbox"/>	+\$0
98	studio white <input type="checkbox"/>	+\$0
CL	cool grey neutral <input type="checkbox"/>	+\$0
LU	soft white <input type="checkbox"/>	+\$0
WL	sandstone <input type="checkbox"/>	+\$0
WN	warm grey neutral <input type="checkbox"/>	+\$0

For 3/8" laminate top (03) or 1/4" laminate top (06)

LBF	neutral twill <input type="checkbox"/>	+\$0
LBG	sarum twill <input type="checkbox"/>	+\$0
LBH	earthen twill <input type="checkbox"/>	+\$0
LBJ	graphite twill <input type="checkbox"/>	+\$0
LBQ	white twill <input type="checkbox"/>	+\$0

Wood-Grain Laminate

For 3/8" laminate top (03) or 1/4" laminate top (06)

LBC	walnut on ash <input type="checkbox"/>	+\$0
LBE	medium red walnut <input type="checkbox"/>	+\$0
HM	natural maple <input type="checkbox"/>	+\$0
HP	light anigre <input type="checkbox"/>	+\$0
LBA	clear on ash <input type="checkbox"/>	+\$0
LBR	phantom ecru <input type="checkbox"/>	+\$0
LBS	phantom cocoa <input type="checkbox"/>	+\$0
LBU	medium matte walnut <input type="checkbox"/>	+\$0
LBV	warm grey teak <input type="checkbox"/>	+\$0
LBB	oak on ash <input type="checkbox"/>	+\$0
LBD	dark brown walnut <input type="checkbox"/>	+\$0
76	light brown walnut <input type="checkbox"/>	+\$0
HX	aged cherry <input type="checkbox"/>	+\$0
HY	walnut on cherry <input type="checkbox"/>	+\$0

Wood Veneer

For 3/8" veneer top (04) or 1/4" veneer top (07)

2U	light brown walnut <input type="checkbox"/>	+\$0
40	dark brown walnut <input type="checkbox"/>	+\$0
ED	aged cherry <input type="checkbox"/>	+\$0
EK	medium red walnut <input type="checkbox"/>	+\$0
EW	medium matte walnut <input type="checkbox"/>	+\$0
ET	clear on ash <input type="checkbox"/>	+\$0
EU	oak on ash <input type="checkbox"/>	+\$0
EV	walnut on ash <input type="checkbox"/>	+\$0
UL	natural maple <input type="checkbox"/>	+\$0
UX	walnut on cherry <input type="checkbox"/>	+\$0

Step 12. Foot Finish

For 4"-high foot (4) or 4"-high foot sleeveless (5)

8Q	folkstone grey <input type="checkbox"/>	+\$0
98	studio white <input type="checkbox"/>	+\$0
WL	sandstone <input type="checkbox"/>	+\$0
91	white <input type="checkbox"/>	+\$0
CL	cool grey neutral <input type="checkbox"/>	+\$0
G1	graphite <input type="checkbox"/>	+\$0
WN	warm grey neutral <input type="checkbox"/>	+\$0
CN	metallic champagne <input type="checkbox"/>	+\$0
EH	metallic bronze <input type="checkbox"/>	+\$0
MS	metallic silver <input type="checkbox"/>	+\$0

Step 13. Pull Finish

For arc pull (A.)

NH	brushed nickel <input type="checkbox"/>	+\$0
NK	black nickel <input type="checkbox"/>	+\$0

For bar pull (K.)

8Q	folkstone grey	+\$0
91	white	+\$0
98	studio white <input type="checkbox"/>	+\$0
G1	graphite <input type="checkbox"/>	+\$0
WL	sandstone <input type="checkbox"/>	+\$0
CN	metallic champagne <input type="checkbox"/>	+\$0
MS	metallic silver <input type="checkbox"/>	+\$0
79	green apple <input type="checkbox"/>	+\$15
MY3	yellow oxide <input type="checkbox"/>	+\$15
RO	red <input type="checkbox"/>	+\$15
TRQ	turquoise <input type="checkbox"/>	+\$15

Step 14. Counterweight

NO	no counterweight <input type="checkbox"/>	+\$0
CB	counterweight <input type="checkbox"/>	+\$70

Step 15. Lock Option

KA	keyed alike <input type="checkbox"/>	-\$10
KC	keyed differently, chrome <input type="checkbox"/>	+\$0
KD	keyed differently, black <input type="checkbox"/>	+\$0

Wood Low Credenza, Open with Drawers, Height Adjustable Leg Integration

FFH73A
FFH73K

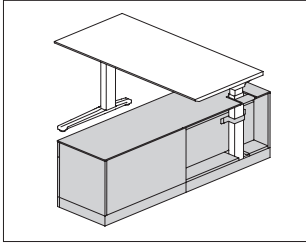

Product Information

Description

This height adjustable table leg credenza provides drawer storage on 1 side with open storage to house a height adjustable leg on the other side. It can be used freestanding or to support 1 end of a surface. It has a $\frac{3}{8}$ "-high or $1\frac{1}{4}$ "-high laminate or veneer top with a laminate or veneer case. It is available with 4"-high architectural feet, 4"-high sleeveless architectural feet or a $2\frac{1}{4}$ "-high base with 1" leveling glides and has a positive interlock system that permits only 1 drawer to open at a time. Drawers have full-extension ball-bearing slides. The file drawer accommodates side-to-side and front-to-back filing of letter-, legal, and A4-size hanging files.

Actual height adjustable table leg credenza widths are $53\frac{3}{4}$ ", $59\frac{3}{4}$ ", $65\frac{3}{4}$ " or $71\frac{3}{4}$ "; actual depth is $19\frac{7}{8}$ ".

Notes

Specify user inbound (S) orientation with surface positioned over the open storage side of credenza and chair positioned in front of drawers (reference illustration above). Specify user outbound (F) orientation with surface positioned over the open storage side of credenza and chair placed outside of the credenza footprint. See Planning Guide for more information.

Leg cutout is always over the open storage side of credenza.

Surface has 1" gap at back of surface.

When using the height adjustable table cutout (C2, C3, T3, T4) with a perpendicular Renew™ or Motia™ height adjustable table, the depth of surface must be equal to, or less than, the depth of the open storage side of credenza. Order height adjustable Renew or Motia table separately.

Arc pull option (A.) conforms to guidelines of Americans with Disabilities Act (ADA).

Grain direction is vertical on veneer and wood-grain laminate fronts.

Open side of Credenza includes 1 adjustable shelf that adjusts in $1\frac{1}{4}$ " increments.

Drawer interior finish is black.

Credenza with 4"-high foot option (4) and $\frac{3}{8}$ " thin top can be used to support a Canvas wall-based frame. Order support bracket, low credenza-to-frame (FT292.) separately.

When using credenza to support 1 end of a surface, order the following product separately:

- Surface support, low credenza, fixed height (FT298.)

$1\frac{1}{4}$ " top (6 and 7) is not removable and cannot be used to support a Canvas wall-based frame. The $1\frac{1}{4}$ " top will add $\frac{5}{8}$ " to overall height of unit.

For view and access of power and the architectural wall, specify partial height, for wall access (P) inner panel height option. Specify full height (F) inner panel when view of wall is not needed.

Please note that on the 4" sleeveless architectural foot (5) glides will be more visible.

For 4"-high foot (4), the stub foot matches the foot finish; For $2\frac{1}{4}$ "-high base (2), the stub foot finish is implied (color to match bracket).

To provide temporary guest seating on a credenza, order cushion top (FF891.) separately.

For additional product options, see Vary Easy Program in Appendices.

For keyed-alike locks, see Keyed-Alike Information in Appendices.

Wood Low Credenza, Open with Drawers, Height Adjustable Leg Integration *continued*

Canvas Office Landscape® Wood Case Credenzas

Dimensions

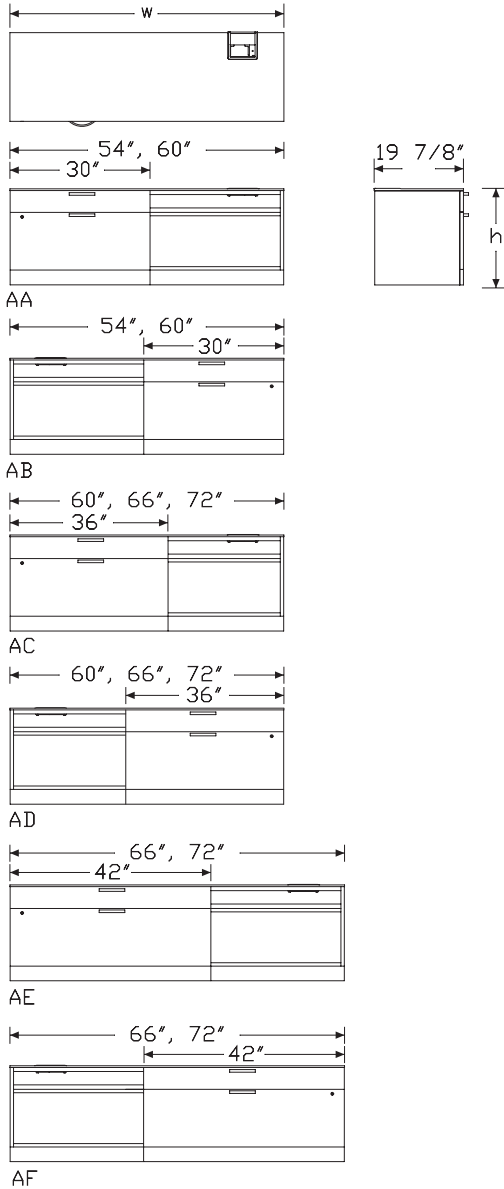

Specification Information

Step 1.

FFH73 A

Step 2. Pull Type

A.	arc pull <input type="checkbox"/> A	+\$0
K.	bar pull <input type="checkbox"/> A	+\$0

Step 3. Width

5	54" wide <input type="checkbox"/> A	+\$3175
6	60" wide <input type="checkbox"/> A	+\$3258
7	66" wide <input type="checkbox"/> A	+\$3391
8	72" wide <input type="checkbox"/> A	+\$3475

Step 4. Depth

2	20" deep <input type="checkbox"/> A	+\$0
----------	-------------------------------------	------

Step 5. Base/Foot Height

2	2 1/4"-high base <input type="checkbox"/> A	+\$100
4	4"-high foot <input type="checkbox"/> A	+\$200
5	4" -high foot sleeveless <input type="checkbox"/> A	+\$150

Step 6. Orientation

S	user inbound <input type="checkbox"/> A	+\$0
F	user outbound <input type="checkbox"/> A	+\$0

Step 7. Configuration

For 54" wide (5)

AA	30" box/file left, open right <input type="checkbox"/> A	+\$0
AB	open left, 30" box/file right <input type="checkbox"/> A	+\$0

For 60" wide (6)

AA	30" box/file left, open right <input type="checkbox"/> A	+\$0
AB	open left, 30" box/file right <input type="checkbox"/> A	+\$0
AC	36" box/file left, open right <input type="checkbox"/> A	+\$100
AD	open left, 36" box/file right <input type="checkbox"/> A	+\$100

For 66" wide (7)

AC	36" box/file left, open right <input type="checkbox"/> A	+\$0
AD	open left, 36" box/file right <input type="checkbox"/> A	+\$0
AE	42" box/file left, open right <input type="checkbox"/> A	+\$150
AF	open left, 42" box/file right <input type="checkbox"/> A	+\$150

Wood Low Credenza, Open with Drawers, Height Adjustable Leg Integration *continued*

For 72" wide (8)

AC	36" box/file left, open right <input type="checkbox"/>	+\$0
AD	open left, 36" box/file right <input type="checkbox"/>	+\$0
AE	42" box/file left, open right <input type="checkbox"/>	+\$200
AF	open left, 42" box/file right <input type="checkbox"/>	+\$200

Step 8. Table Integration

For 54" wide (5), 60" wide (6), or 66" wide (7) with 30" box/file left, open right (AA), open left, 30" box/file right (AB), 36" box/file left, open right (AC), 42" box/file left, open right (AE), open left, 36" box/file right (AD), or open left, 42" box/file right (AF)

C2	cutout for use with C-Leg and 24" D surface <input type="checkbox"/>	+\$0
-----------	--	------

For 60" wide (6), 66" wide (7), or 72" wide (8) with 30" box/file left, open right (AA), 36" box/file left, open right (AC), open left, 30" box/file right (AB), open left, 36" box/file right (AD), 42" box/file left, open right (AE), or open left, 42" box/file right (AF)

C2	cutout for use with C-Leg and 24" D surface <input type="checkbox"/>	+\$0
C3	cutout for use with C-Leg and 30" D surface <input type="checkbox"/>	+\$0
T3	cutout for use with T-Leg and 30" D surface <input type="checkbox"/>	+\$0

For 72" wide (8) with 36" box/file left, open right (AC) or open left, 36" box/file right (AD)

C2	cutout for use with C-Leg and 24" D surface <input type="checkbox"/>	+\$0
C3	cutout for use with C-Leg and 30" D surface <input type="checkbox"/>	+\$0
T3	cutout for use with T-Leg and 30" D surface <input type="checkbox"/>	+\$0
T4	cutout for use with T-Leg and 36" D surface <input type="checkbox"/>	+\$0

Step 9. Inner Panel Height

F	full-height <input type="checkbox"/>	+\$50
P	partial height, for wall access <input type="checkbox"/>	+\$35

Step 10. Back Panel Type

F	full height, removable back <input type="checkbox"/>	+\$50
N	no back <input type="checkbox"/>	+\$0

Step 11. Case/Front Material

For 54" wide (5) or 60" wide (6)

L	laminated case/front <input type="checkbox"/>	+\$0
C	laminated case/veneer front <input type="checkbox"/>	+\$800
W	veneer case/front <input type="checkbox"/>	+\$1730

For 66" wide (7) or 72" wide (8)

L	laminated case/front <input type="checkbox"/>	+\$0
C	laminated case/veneer front <input type="checkbox"/>	+\$923
W	veneer case/front <input type="checkbox"/>	+\$1923

Step 12. Top

3	3/8" laminate top <input type="checkbox"/>	+\$150
4	3/8" veneer top <input type="checkbox"/>	+\$300
6	1 1/4" laminate top <input type="checkbox"/>	+\$300
7	1 1/4" veneer <input type="checkbox"/>	+\$600

Step 13. Drawer Body Material

W	wood <input type="checkbox"/>	+\$0
----------	-------------------------------	------

Wood Low Credenza, Open with Drawers, Height Adjustable Leg Integration *continued*

Step 14. Case/Edge Finish

For laminate case/front (L) or laminate case/veneer front (C)

76	light brown walnut <input type="checkbox"/>	+\$0
8Q	folkstone grey <input type="checkbox"/>	+\$0
91	white <input type="checkbox"/>	+\$0
98	studio white <input type="checkbox"/>	+\$0
CL	cool grey neutral <input type="checkbox"/>	+\$0
HM	natural maple <input type="checkbox"/>	+\$0
HP	light anigre <input type="checkbox"/>	+\$0
HX	aged cherry <input type="checkbox"/>	+\$0
HY	walnut on cherry <input type="checkbox"/>	+\$0
LA	light ash <input type="checkbox"/>	+\$0
LBA	clear on ash <input type="checkbox"/>	+\$0
LBR	phantom ecru <input type="checkbox"/>	+\$0
LBS	phantom cocoa <input type="checkbox"/>	+\$0
LBU	medium matte walnut <input type="checkbox"/>	+\$0
LBV	warm grey teak <input type="checkbox"/>	+\$0
LBB	oak on ash <input type="checkbox"/>	+\$0
LBC	walnut on ash <input type="checkbox"/>	+\$0
LBD	dark brown walnut <input type="checkbox"/>	+\$0
LBE	medium red walnut <input type="checkbox"/>	+\$0
LBF	neutral twill <input type="checkbox"/>	+\$0
LBG	sarum twill <input type="checkbox"/>	+\$0
LBH	earthen twill <input type="checkbox"/>	+\$0
LBJ	graphite twill <input type="checkbox"/>	+\$0
LBK	pewter mesh <input type="checkbox"/>	+\$0
LBL	steel mesh <input type="checkbox"/>	+\$0
LBM	crisp linen <input type="checkbox"/>	+\$0
LBN	classic linen <input type="checkbox"/>	+\$0
LBP	casual linen <input type="checkbox"/>	+\$0
LBQ	white twill <input type="checkbox"/>	+\$0
LU	soft white <input type="checkbox"/>	+\$0
WL	sandstone <input type="checkbox"/>	+\$0
WN	warm grey neutral <input type="checkbox"/>	+\$0

Wood Veneer

For veneer case/front (W)

2U	light brown walnut <input type="checkbox"/>	+\$0
40	dark brown walnut <input type="checkbox"/>	+\$0
ED	aged cherry <input type="checkbox"/>	+\$0
EK	medium red walnut <input type="checkbox"/>	+\$0
EW	medium matte walnut <input type="checkbox"/>	+\$0
ET	clear on ash <input type="checkbox"/>	+\$0
EU	oak on ash <input type="checkbox"/>	+\$0
EV	walnut on ash <input type="checkbox"/>	+\$0
UL	natural maple <input type="checkbox"/>	+\$0
UX	walnut on cherry <input type="checkbox"/>	+\$0

Wood Low Credenza, Open with Drawers, Height Adjustable Leg Integration *continued*

Step 15. Front/Edge Finish

For laminate case/front (L)

76	light brown walnut <input type="checkbox"/>	+\$0
8Q	folkstone grey <input type="checkbox"/>	+\$0
91	white <input type="checkbox"/>	+\$0
98	studio white <input type="checkbox"/>	+\$0
CL	cool grey neutral <input type="checkbox"/>	+\$0
HM	natural maple <input type="checkbox"/>	+\$0
HP	light anigre <input type="checkbox"/>	+\$0
HX	aged cherry <input type="checkbox"/>	+\$0
HY	walnut on cherry <input type="checkbox"/>	+\$0
LA	light ash <input type="checkbox"/>	+\$0
LBA	clear on ash <input type="checkbox"/>	+\$0
LBR	phantom ecru <input type="checkbox"/>	+\$0
LBS	phantom cocoa <input type="checkbox"/>	+\$0
LBU	medium matte walnut <input type="checkbox"/>	+\$0
LBV	warm grey teak <input type="checkbox"/>	+\$0
LBB	oak on ash <input type="checkbox"/>	+\$0
LBC	walnut on ash <input type="checkbox"/>	+\$0
LBD	dark brown walnut <input type="checkbox"/>	+\$0
LBE	medium red walnut <input type="checkbox"/>	+\$0
LBF	neutral twill <input type="checkbox"/>	+\$0
LBG	sarum twill <input type="checkbox"/>	+\$0
LBH	earthen twill <input type="checkbox"/>	+\$0
LBJ	graphite twill <input type="checkbox"/>	+\$0
LBK	pewter mesh <input type="checkbox"/>	+\$0
LBL	steel mesh <input type="checkbox"/>	+\$0
LBM	crisp linen <input type="checkbox"/>	+\$0
LBN	classic linen <input type="checkbox"/>	+\$0
LBP	casual linen <input type="checkbox"/>	+\$0
LBQ	white twill <input type="checkbox"/>	+\$0
LU	soft white <input type="checkbox"/>	+\$0
WL	sandstone <input type="checkbox"/>	+\$0
WN	warm grey neutral <input type="checkbox"/>	+\$0

Wood Veneer

For laminate case/veneer front (C) or veneer case/front (W)

2U	light brown walnut <input type="checkbox"/>	+\$0
40	dark brown walnut <input type="checkbox"/>	+\$0
ED	aged cherry <input type="checkbox"/>	+\$0
EK	medium red walnut <input type="checkbox"/>	+\$0
EW	medium matte walnut <input type="checkbox"/>	+\$0
ET	clear on ash <input type="checkbox"/>	+\$0
EU	oak on ash <input type="checkbox"/>	+\$0
EV	walnut on ash <input type="checkbox"/>	+\$0
UL	natural maple <input type="checkbox"/>	+\$0
UX	walnut on cherry <input type="checkbox"/>	+\$0

Wood Low Credenza, Open with Drawers, Height Adjustable Leg Integration *continued*

Step 16. Top/Edge Finish

For 3/8" laminate top (3)

76	light brown walnut <input type="checkbox"/>	+\$0
8Q	folkstone grey <input type="checkbox"/>	+\$0
91	white <input type="checkbox"/>	+\$0
98	studio white <input type="checkbox"/>	+\$0
CL	cool grey neutral <input type="checkbox"/>	+\$0
HM	natural maple <input type="checkbox"/>	+\$0
HP	light anigre <input type="checkbox"/>	+\$0
HX	aged cherry <input type="checkbox"/>	+\$0
HY	walnut on cherry <input type="checkbox"/>	+\$0
LA	light ash <input type="checkbox"/>	+\$0
LBA	clear on ash <input type="checkbox"/>	+\$0
LBR	phantom ecru <input type="checkbox"/>	+\$0
LBS	phantom cocoa <input type="checkbox"/>	+\$0
LBU	medium matte walnut <input type="checkbox"/>	+\$0
LBV	warm grey teak <input type="checkbox"/>	+\$0
LBB	oak on ash <input type="checkbox"/>	+\$0
LBC	walnut on ash <input type="checkbox"/>	+\$0
LBD	dark brown walnut <input type="checkbox"/>	+\$0
LBE	medium red walnut <input type="checkbox"/>	+\$0
LBF	neutral twill <input type="checkbox"/>	+\$0
LBG	sarum twill <input type="checkbox"/>	+\$0
LBH	earthen twill <input type="checkbox"/>	+\$0
LBJ	graphite twill <input type="checkbox"/>	+\$0
LBK	pewter mesh <input type="checkbox"/>	+\$0
LBL	steel mesh <input type="checkbox"/>	+\$0
LBM	crisp linen <input type="checkbox"/>	+\$0
LBN	classic linen <input type="checkbox"/>	+\$0
LBP	casual linen <input type="checkbox"/>	+\$0
LBQ	white twill <input type="checkbox"/>	+\$0
LU	soft white <input type="checkbox"/>	+\$0
WL	sandstone <input type="checkbox"/>	+\$0
WN	warm grey neutral <input type="checkbox"/>	+\$0

For 1 1/4" laminate top (6)

76	light brown walnut <input type="checkbox"/>	+\$0
8Q	folkstone grey <input type="checkbox"/>	+\$0
91	white <input type="checkbox"/>	+\$0
98	studio white <input type="checkbox"/>	+\$0
CL	cool grey neutral <input type="checkbox"/>	+\$0
HF	inner tone light <input type="checkbox"/>	+\$0
HM	natural maple <input type="checkbox"/>	+\$0
HP	light anigre <input type="checkbox"/>	+\$0
HT	inner tone <input type="checkbox"/>	+\$0
HX	aged cherry <input type="checkbox"/>	+\$0

HY	walnut on cherry <input type="checkbox"/>	+\$0
LA	light ash <input type="checkbox"/>	+\$0
LBA	clear on ash <input type="checkbox"/>	+\$0
LBR	phantom ecru <input type="checkbox"/>	+\$0
LBS	phantom cocoa <input type="checkbox"/>	+\$0
LBU	medium matte walnut <input type="checkbox"/>	+\$0
LBV	warm grey teak <input type="checkbox"/>	+\$0
LBB	oak on ash <input type="checkbox"/>	+\$0
LBC	walnut on ash <input type="checkbox"/>	+\$0
LBD	dark brown walnut <input type="checkbox"/>	+\$0
LBE	medium red walnut <input type="checkbox"/>	+\$0
LBF	neutral twill <input type="checkbox"/>	+\$0
LBG	sarum twill <input type="checkbox"/>	+\$0
LBH	earthen twill <input type="checkbox"/>	+\$0
LBJ	graphite twill <input type="checkbox"/>	+\$0
LBK	pewter mesh <input type="checkbox"/>	+\$0
LBL	steel mesh <input type="checkbox"/>	+\$0
LBM	crisp linen <input type="checkbox"/>	+\$0
LBN	classic linen <input type="checkbox"/>	+\$0
LBP	casual linen <input type="checkbox"/>	+\$0
LBQ	white twill <input type="checkbox"/>	+\$0
LM	mahogany <input type="checkbox"/>	+\$0
LT	light tone <input type="checkbox"/>	+\$0
LU	soft white <input type="checkbox"/>	+\$0
MT	medium tone <input type="checkbox"/>	+\$0
WL	sandstone <input type="checkbox"/>	+\$0
WN	warm grey neutral <input type="checkbox"/>	+\$0

Wood Veneer

For 3/8" veneer top (4) or 1 1/4" veneer (7)

2U	light brown walnut <input type="checkbox"/>	+\$0
40	dark brown walnut <input type="checkbox"/>	+\$0
ED	aged cherry <input type="checkbox"/>	+\$0
EK	medium red walnut <input type="checkbox"/>	+\$0
EW	medium matte walnut <input type="checkbox"/>	+\$0
ET	clear on ash <input type="checkbox"/>	+\$0
EU	oak on ash <input type="checkbox"/>	+\$0
EV	walnut on ash <input type="checkbox"/>	+\$0
UL	natural maple <input type="checkbox"/>	+\$0
UX	walnut on cherry <input type="checkbox"/>	+\$0

Wood Low Credenza, Open with Drawers, Height Adjustable Leg Integration *continued*

Step 17. Foot Finish

For 4"-high foot (4) or 4"-high foot sleeveless (5)

8Q	folkstone grey <input type="checkbox"/>	+\$0
98	studio white <input type="checkbox"/>	+\$0
WL	sandstone <input type="checkbox"/>	+\$0
91	white <input type="checkbox"/>	+\$0
CL	cool grey neutral <input type="checkbox"/>	+\$0
G1	graphite <input type="checkbox"/>	+\$0
WN	warm grey neutral <input type="checkbox"/>	+\$0
CN	metallic champagne <input type="checkbox"/>	+\$0
EH	metallic bronze <input type="checkbox"/>	+\$0
MS	metallic silver <input type="checkbox"/>	+\$0

Step 18. Pull Finish

For arc pull (A.)

NH	brushed nickel <input type="checkbox"/>	+\$0
NK	black nickel <input type="checkbox"/>	+\$0

For bar pull (K.)

79	green apple <input type="checkbox"/>	+\$0
8Q	folkstone grey	+\$0
91	white	+\$0
98	studio white <input type="checkbox"/>	+\$0
CN	metallic champagne <input type="checkbox"/>	+\$0
G1	graphite <input type="checkbox"/>	+\$0
MS	metallic silver <input type="checkbox"/>	+\$0
MY3	yellow oxide <input type="checkbox"/>	+\$0
RO	red <input type="checkbox"/>	+\$0
TRQ	turquoise <input type="checkbox"/>	+\$0
WL	sandstone <input type="checkbox"/>	+\$0

Step 19. Counterweight

NO	no counterweight <input type="checkbox"/>	+\$0
CB	counterweight <input type="checkbox"/>	+\$70

Step 20. Lock Option

KA	keyed alike <input type="checkbox"/>	+\$0
KC	keyed differently, chrome <input type="checkbox"/>	+\$0
KD	keyed differently, black <input type="checkbox"/>	+\$0

Step 21. Grommet Finish

8Q	folkstone grey <input type="checkbox"/>	+\$0
91	white <input type="checkbox"/>	+\$0
98	studio white <input type="checkbox"/>	+\$0
CL	cool grey neutral <input type="checkbox"/>	+\$0
CN	metallic champagne <input type="checkbox"/>	+\$0
EH	metallic bronze <input type="checkbox"/>	+\$0
G1	graphite <input type="checkbox"/>	+\$0
MS	metallic silver <input type="checkbox"/>	+\$0
WL	sandstone <input type="checkbox"/>	+\$0
WN	warm grey neutral <input type="checkbox"/>	+\$0

Wood Low Credenza, Open with Drawers, Power Access

FFV73A
FFV73K

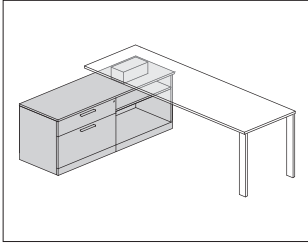

Product Information

Description

This power access credenza provides drawer storage on 1 side and open storage on the other side. It can be used freestanding or to support 1 end of a surface. It has a $\frac{3}{8}$ "-high or $\frac{1}{4}$ "-high laminate or veneer top with a laminate or veneer case. It is available with 4"-high architectural feet, 4"-high sleeveless architectural feet or a $2\frac{1}{4}$ "-high base with 1" leveling glides and has a positive interlock system that permits only 1 drawer to open at a time. Drawers have full-extension ball-bearing slides. The file drawer accommodates side-to-side and front-to-back filing of letter-, legal, and A4-size hanging files.

Actual power access credenza widths are $53\frac{3}{4}$ ", $59\frac{3}{4}$ ", $65\frac{3}{4}$ " or $71\frac{3}{4}$ "; actual depth is $19\frac{7}{8}$ ".

Notes

Specify user inbound (S) orientation when surface is positioned over the open storage side of credenza and chair is positioned in front of drawers (reference illustration above). Specify user outbound (F) orientation when surface is positioned over the open storage side of credenza and chair is placed outside of the credenza footprint. See Planning Guide for more information.

When using the stanchion cutout (S2, S3, S4) with a perpendicular surface, the depth of surface must be equal to, or less than, the depth of the open storage side of credenza. Order rectangular surface (FTS10.) or rectangular surface, peninsula end (FTS34.) separately. Surface leg support must be outbound. Surface must be field cut out to match the grommet mounted electrical distributor cutout requirements.

Order the following products separately:

- Fixed surface support, low credenza, power chase (FV298.)
- Logic G1000 grommet mounted electrical distributor (Y1425.D or .G) separately.

Right (RG), left (LG), and center (CG) grommet access are over the open storage side of credenza. Grommet option is available to route power cords from top of surface through low credenza, to power access on the wall. Specify no top cutout (NC) when cord routing is only needed in open side of credenza.

Arc pull option (A.) conforms to guidelines of Americans with Disabilities Act (ADA).

Grain direction is vertical on veneer and wood-grain laminate fronts.

Open side of Credenza includes 1 adjustable shelf that adjusts in $\frac{1}{4}$ " increments.

Credenza with 4"-high foot option (4) and $\frac{3}{8}$ " thin top can be used to support a Canvas wall-based frame. Order support bracket, low credenza-to-frame (FT292.) separately.

When using credenza to support 1 end of a surface, order the following product separately:

- Fixed surface support, low credenza, power chase (FV298.)

$\frac{1}{4}$ " top (6 and 7) is not removable and cannot be used to support a Canvas wall-based frame. The $\frac{1}{4}$ " top will add $\frac{5}{8}$ " to overall height of unit.

For view and access of power and the architectural wall, specify partial height, for wall access (P) inner panel height option. Specify full height (F) inner panel when view of wall is not needed.

Please note that on the 4" sleeveless architectural foot (5) glides will be more visible.

To provide temporary guest seating on a credenza, order cushion top (FF891.) separately.

For additional product options, see Vary Easy Program in Appendices. For keyed-alike locks, see Keyed-Alike Information in Appendices.

Wood Low Credenza, Open with Drawers, Power Access *continued*

Dimensions

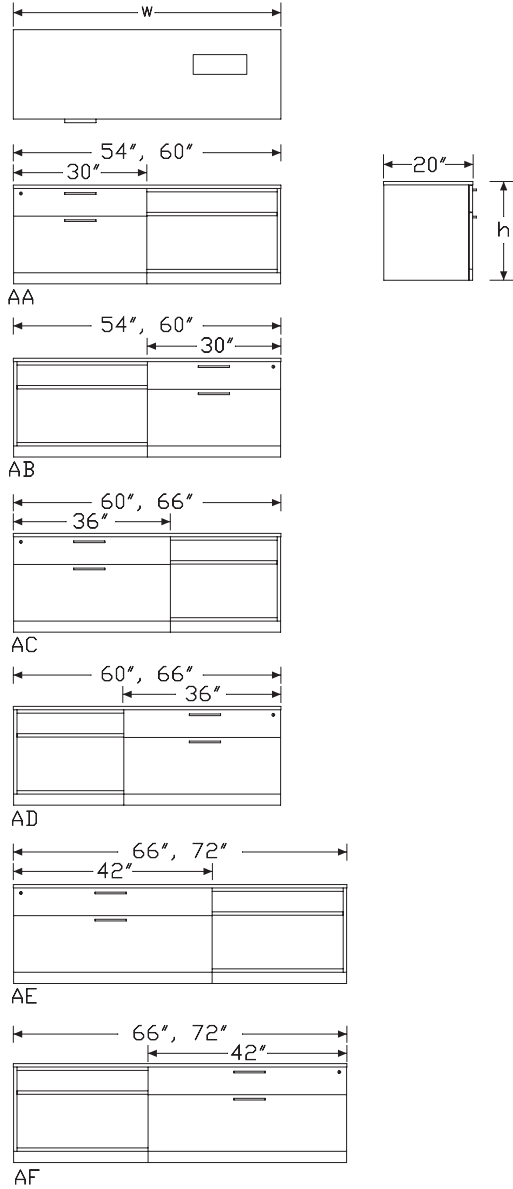

Specification Information

Step 1.

FFV73 [A]

Step 2. Pull Type

A.	arc pull [A]	+\$0
K.	bar pull [A]	+\$0

Step 3. Width

5	54" wide [A]	+\$2735
6	60" wide [A]	+\$2844
7	66" wide [A]	+\$3028
8	72" wide [A]	+\$3099

Step 4. Depth

2	20" deep [A]	+\$0
----------	--------------	------

Step 5. Base/Foot Height

2	2 1/4"-high base [A]	+\$100
4	4"-high foot [A]	+\$200
5	4" -high foot sleeveless [A]	+\$150

Step 6. Orientation

S	user inbound [A]	+\$0
F	user outbound [A]	+\$0

Step 7. Configuration

For 54" wide (5)

AA	30" box/file left, open right [A]	+\$0
AB	open left, 30" box/file right [A]	+\$0

For 60" wide (6)

AA	30" box/file left, open right [A]	+\$0
AB	open left, 30" box/file right [A]	+\$0
AC	36" box/file left, open right [A]	+\$100
AD	open left, 36" box/file right [A]	+\$100

For 66" wide (7)

AC	36" box/file left, open right [A]	+\$0
AD	open left, 36" box/file right [A]	+\$0
AE	42" box/file left, open right [A]	+\$150
AF	open left, 42" box/file right [A]	+\$150

Wood Low Credenza, Open with Drawers, Power Access *continued*

For 72" wide (8)

AC	36" box/file left, open right <input type="checkbox"/>	+\$0
AD	open left, 36" box/file right <input type="checkbox"/>	+\$0
AE	42" box/file left, open right <input type="checkbox"/>	+\$200
AF	open left, 42" box/file right <input type="checkbox"/>	+\$200

Step 8. Top Power Access

For 54" wide (5), 60" wide (6), or 66" wide (7) with 30" box/file left, open right (AA), open left, 30" box/file right (AB), 36" box/file left, open right (AC), 42" box/file left, open right (AE), open left, 36" box/file right (AD), or open left, 42" box/file right (AF)

S2	stanchion cutout, for use with a 24" deep surface <input type="checkbox"/>	+\$0
LG	left grommet access <input type="checkbox"/>	+\$0
RG	right grommet access <input type="checkbox"/>	+\$0
CG	center grommet access <input type="checkbox"/>	+\$0
NC	no top cutout <input type="checkbox"/>	+\$0

For 60" wide (6), 66" wide (7), or 72" wide (8) with 30" box/file left, open right (AA), 36" box/file left, open right (AC), open left, 30" box/file right (AB), open left, 36" box/file right (AD), 42" box/file left, open right (AE), or open left, 42" box/file right (AF)

S2	stanchion cutout, for use with a 24" deep surface <input type="checkbox"/>	+\$0
S3	stanchion cutout, for use with a 30" deep surface <input type="checkbox"/>	+\$0
LG	left grommet access <input type="checkbox"/>	+\$0
RG	right grommet access <input type="checkbox"/>	+\$0
CG	center grommet access <input type="checkbox"/>	+\$0
NC	no top cutout <input type="checkbox"/>	+\$0

For 72" wide (8) with 36" box/file left, open right (AC) or open left, 36" box/file right (AD)

S2	stanchion cutout, for use with a 24" deep surface <input type="checkbox"/>	+\$0
S3	stanchion cutout, for use with a 30" deep surface <input type="checkbox"/>	+\$0
S4	stanchion cutout, for use with a 36" deep surface <input type="checkbox"/>	+\$0
LG	left grommet access <input type="checkbox"/>	+\$0
RG	right grommet access <input type="checkbox"/>	+\$0
CG	center grommet access <input type="checkbox"/>	+\$0
NC	no top cutout <input type="checkbox"/>	+\$0

Step 9. Inner Panel Height

For stanchion cutout, for use with a 24" deep surface (S2), left grommet access (LG), stanchion cutout, for use with a 30" deep surface (S3), right grommet access (RG), stanchion cutout, for use with a 36" deep surface (S4), or center grommet access (CG)

F	full height <input type="checkbox"/>	+\$50
P	partial height, for wall access <input type="checkbox"/>	+\$35

For no top cutout (NC)

P	partial height, for wall access <input type="checkbox"/>	+\$35
----------	--	-------

Step 10. Back Panel Type

For 4"-high foot (4) or 4"-high foot sleeveless (5)

F	full height, removable back <input type="checkbox"/>	+\$50
N	no back <input type="checkbox"/>	+\$0

For 2 1/4"-high base (2)

N	no back <input type="checkbox"/>	+\$0
----------	----------------------------------	------

Step 11. Case/Front Material

For 54" wide (5) or 60" wide (6)

L	laminated case/front <input type="checkbox"/>	+\$0
C	laminated case/veneer front <input type="checkbox"/>	+\$800
W	veneer case/front <input type="checkbox"/>	+\$1730

For 66" wide (7) or 72" wide (8)

L	laminated case/front <input type="checkbox"/>	+\$0
C	laminated case/veneer front <input type="checkbox"/>	+\$923
W	veneer case/front <input type="checkbox"/>	+\$1923

Step 12. Top

3	3/8" laminate top <input type="checkbox"/>	+\$150
4	3/8" veneer top <input type="checkbox"/>	+\$300
6	1 1/4" laminate top <input type="checkbox"/>	+\$300
7	1 1/4" veneer top <input type="checkbox"/>	+\$600

Step 13. Drawer Body Material

W	wood <input type="checkbox"/>	+\$0
----------	-------------------------------	------

Wood Low Credenza, Open with Drawers, Power Access *continued*

Step 14. Case/Edge Finish

For laminate case/front (L) or laminate case/veneer front (C)

76	light brown walnut <input type="checkbox"/>	+\$0
8Q	folkstone grey <input type="checkbox"/>	+\$0
91	white <input type="checkbox"/>	+\$0
98	studio white <input type="checkbox"/>	+\$0
CL	cool grey neutral <input type="checkbox"/>	+\$0
HM	natural maple <input type="checkbox"/>	+\$0
HP	light anigre <input type="checkbox"/>	+\$0
HX	aged cherry <input type="checkbox"/>	+\$0
HY	walnut on cherry <input type="checkbox"/>	+\$0
LA	light ash <input type="checkbox"/>	+\$0
LBA	clear on ash <input type="checkbox"/>	+\$0
LBR	phantom ecru <input type="checkbox"/>	+\$0
LBS	phantom cocoa <input type="checkbox"/>	+\$0
LBU	medium matte walnut <input type="checkbox"/>	+\$0
LBV	warm grey teak <input type="checkbox"/>	+\$0
LBB	oak on ash <input type="checkbox"/>	+\$0
LBC	walnut on ash <input type="checkbox"/>	+\$0
LBD	dark brown walnut <input type="checkbox"/>	+\$0
LBE	medium red walnut <input type="checkbox"/>	+\$0
LBF	neutral twill <input type="checkbox"/>	+\$0
LBG	sarum twill <input type="checkbox"/>	+\$0
LBH	earthen twill <input type="checkbox"/>	+\$0
LBJ	graphite twill <input type="checkbox"/>	+\$0
LBK	pewter mesh <input type="checkbox"/>	+\$0
LBL	steel mesh <input type="checkbox"/>	+\$0
LBM	crisp linen <input type="checkbox"/>	+\$0
LBN	classic linen <input type="checkbox"/>	+\$0
LBP	casual linen <input type="checkbox"/>	+\$0
LBQ	white twill <input type="checkbox"/>	+\$0
LU	soft white <input type="checkbox"/>	+\$0
WL	sandstone <input type="checkbox"/>	+\$0
WN	warm grey neutral <input type="checkbox"/>	+\$0

For veneer case/front (W)

2U	light brown walnut <input type="checkbox"/>	+\$0
40	dark brown walnut <input type="checkbox"/>	+\$0
ED	aged cherry <input type="checkbox"/>	+\$0
EK	medium red walnut <input type="checkbox"/>	+\$0
EW	medium matte walnut <input type="checkbox"/>	+\$0
ET	clear on ash <input type="checkbox"/>	+\$0
EU	oak on ash <input type="checkbox"/>	+\$0
EV	walnut on ash <input type="checkbox"/>	+\$0
UL	natural maple <input type="checkbox"/>	+\$0
UX	walnut on cherry <input type="checkbox"/>	+\$0

Step 15. Front/Edge Finish

For laminate case/front (L)

76	light brown walnut <input type="checkbox"/>	+\$0
8Q	folkstone grey <input type="checkbox"/>	+\$0
91	white <input type="checkbox"/>	+\$0
98	studio white <input type="checkbox"/>	+\$0
CL	cool grey neutral <input type="checkbox"/>	+\$0
HM	natural maple <input type="checkbox"/>	+\$0
HP	light anigre <input type="checkbox"/>	+\$0
HX	aged cherry <input type="checkbox"/>	+\$0
HY	walnut on cherry <input type="checkbox"/>	+\$0
LA	light ash <input type="checkbox"/>	+\$0
LBA	clear on ash <input type="checkbox"/>	+\$0
LBR	phantom ecru <input type="checkbox"/>	+\$0
LBS	phantom cocoa <input type="checkbox"/>	+\$0
LBU	medium matte walnut <input type="checkbox"/>	+\$0
LBV	warm grey teak <input type="checkbox"/>	+\$0
LBB	oak on ash <input type="checkbox"/>	+\$0
LBC	walnut on ash <input type="checkbox"/>	+\$0
LBD	dark brown walnut <input type="checkbox"/>	+\$0
LBE	medium red walnut <input type="checkbox"/>	+\$0
LBF	neutral twill <input type="checkbox"/>	+\$0
LBG	sarum twill <input type="checkbox"/>	+\$0
LBH	earthen twill <input type="checkbox"/>	+\$0
LBJ	graphite twill <input type="checkbox"/>	+\$0
LBK	pewter mesh <input type="checkbox"/>	+\$0
LBL	steel mesh <input type="checkbox"/>	+\$0
LBM	crisp linen <input type="checkbox"/>	+\$0
LBN	classic linen <input type="checkbox"/>	+\$0
LBP	casual linen <input type="checkbox"/>	+\$0
LBQ	white twill <input type="checkbox"/>	+\$0
LU	soft white <input type="checkbox"/>	+\$0
WL	sandstone <input type="checkbox"/>	+\$0
WN	warm grey neutral <input type="checkbox"/>	+\$0

For laminate case/veneer front (C) or veneer case/front (W)

2U	light brown walnut <input type="checkbox"/>	+\$0
40	dark brown walnut <input type="checkbox"/>	+\$0
ED	aged cherry <input type="checkbox"/>	+\$0
EK	medium red walnut <input type="checkbox"/>	+\$0
EW	medium matte walnut <input type="checkbox"/>	+\$0
ET	clear on ash <input type="checkbox"/>	+\$0
EU	oak on ash <input type="checkbox"/>	+\$0
EV	walnut on ash <input type="checkbox"/>	+\$0
UL	natural maple <input type="checkbox"/>	+\$0
UX	walnut on cherry <input type="checkbox"/>	+\$0

Wood Low Credenza, Open with Drawers, Power Access *continued*

Step 16. Top/Edge Finish

For 1¹/₄" laminate top (6)

76	light brown walnut <input type="checkbox"/>	+\$0
8Q	folkstone grey <input type="checkbox"/>	+\$0
91	white <input type="checkbox"/>	+\$0
98	studio white <input type="checkbox"/>	+\$0
CL	cool grey neutral <input type="checkbox"/>	+\$0
HF	inner tone light <input type="checkbox"/>	+\$0
HM	natural maple <input type="checkbox"/>	+\$0
HP	light anigre <input type="checkbox"/>	+\$0
HT	inner tone <input type="checkbox"/>	+\$0
HX	aged cherry <input type="checkbox"/>	+\$0
HY	walnut on cherry <input type="checkbox"/>	+\$0
LA	light ash <input type="checkbox"/>	+\$0
LBA	clear on ash <input type="checkbox"/>	+\$0
LBB	oak on ash <input type="checkbox"/>	+\$0
LBC	walnut on ash <input type="checkbox"/>	+\$0
LBD	dark brown walnut <input type="checkbox"/>	+\$0
LBE	medium red walnut <input type="checkbox"/>	+\$0
LBF	neutral twill <input type="checkbox"/>	+\$0
LBG	sarum twill <input type="checkbox"/>	+\$0
LBH	earthen twill <input type="checkbox"/>	+\$0
LBJ	graphite twill <input type="checkbox"/>	+\$0
LBK	pewter mesh <input type="checkbox"/>	+\$0
LBL	steel mesh <input type="checkbox"/>	+\$0
LBM	crisp linen <input type="checkbox"/>	+\$0
LBN	classic linen <input type="checkbox"/>	+\$0
LBP	casual linen <input type="checkbox"/>	+\$0
LBQ	white twill <input type="checkbox"/>	+\$0
LBR	phantom ecru <input type="checkbox"/>	+\$0
LBS	phantom cocoa <input type="checkbox"/>	+\$0
LBU	medium matte walnut <input type="checkbox"/>	+\$0
LBV	warm grey teak <input type="checkbox"/>	+\$0
LM	mahogany <input type="checkbox"/>	+\$0
LT	light tone <input type="checkbox"/>	+\$0
LU	soft white <input type="checkbox"/>	+\$0
MT	medium tone <input type="checkbox"/>	+\$0
WL	sandstone <input type="checkbox"/>	+\$0
WN	warm grey neutral <input type="checkbox"/>	+\$0

For 3³/₈" laminate top (3)

76	light brown walnut <input type="checkbox"/>	+\$0
8Q	folkstone grey <input type="checkbox"/>	+\$0
91	white <input type="checkbox"/>	+\$0
98	studio white <input type="checkbox"/>	+\$0
CL	cool grey neutral <input type="checkbox"/>	+\$0
HM	natural maple <input type="checkbox"/>	+\$0
HP	light anigre <input type="checkbox"/>	+\$0
HX	aged cherry <input type="checkbox"/>	+\$0
HY	walnut on cherry <input type="checkbox"/>	+\$0
LA	light ash <input type="checkbox"/>	+\$0
LBA	clear on ash <input type="checkbox"/>	+\$0
LBB	oak on ash <input type="checkbox"/>	+\$0
LBC	walnut on ash <input type="checkbox"/>	+\$0
LBD	dark brown walnut <input type="checkbox"/>	+\$0
LBE	medium red walnut <input type="checkbox"/>	+\$0
LBF	neutral twill <input type="checkbox"/>	+\$0
LBG	sarum twill <input type="checkbox"/>	+\$0
LBH	earthen twill <input type="checkbox"/>	+\$0
LBJ	graphite twill <input type="checkbox"/>	+\$0
LBK	pewter mesh <input type="checkbox"/>	+\$0
LBL	steel mesh <input type="checkbox"/>	+\$0
LBM	crisp linen <input type="checkbox"/>	+\$0
LBN	classic linen <input type="checkbox"/>	+\$0
LBP	casual linen <input type="checkbox"/>	+\$0
LBQ	white twill <input type="checkbox"/>	+\$0
LU	soft white <input type="checkbox"/>	+\$0
WL	sandstone <input type="checkbox"/>	+\$0
WN	warm grey neutral <input type="checkbox"/>	+\$0

For 3³/₈" veneer top (4) or 1¹/₄" veneer top (7)

2U	light brown walnut <input type="checkbox"/>	+\$0
40	dark brown walnut <input type="checkbox"/>	+\$0
ED	aged cherry <input type="checkbox"/>	+\$0
EK	medium red walnut <input type="checkbox"/>	+\$0
ET	clear on ash <input type="checkbox"/>	+\$0
EU	oak on ash <input type="checkbox"/>	+\$0
EV	walnut on ash <input type="checkbox"/>	+\$0
EW	medium matte walnut <input type="checkbox"/>	+\$0
UL	natural maple <input type="checkbox"/>	+\$0
UX	walnut on cherry <input type="checkbox"/>	+\$0

Wood Low Credenza, Open with Drawers, Power Access *continued*

Step 17. Foot Finish

For 4"-high foot (4) or 4" -high foot sleeveless (5)

8Q	folkstone grey [A]	+\$0
91	white [A]	+\$0
98	studio white [A]	+\$0
CL	cool grey neutral [A]	+\$0
CN	metallic champagne [A]	+\$0
EH	metallic bronze [A]	+\$0
G1	graphite [A]	+\$0
MS	metallic silver [A]	+\$0
WL	sandstone [A]	+\$0
WN	warm grey neutral [A]	+\$0

Step 18. Pull Finish

For arc pull (A.)

NH	brushed nickel [A]	+\$0
NK	black nickel [A]	+\$0

For bar pull (K.)

79	green apple [A]	+\$0
8Q	folkstone grey [A]	+\$0
91	white [A]	+\$0
98	studio white [A]	+\$0
CN	metallic champagne [A]	+\$0
G1	graphite [A]	+\$0
MS	metallic silver [A]	+\$0
MY3	yellow oxide [A]	+\$0
RO	red [A]	+\$0
TRQ	turquoise [A]	+\$0
WL	sandstone [A]	+\$0

Step 19. Counterweight

NO	no counterweight [A]	+\$0
-----------	----------------------	------

Step 20. Lock Option

KA	keyed alike, black [A]	+\$0
KC	keyed differently, chrome [A]	+\$0
KD	keyed differently, black [A]	+\$0

Step 21. Grommet Finish

For left grommet access (LG), right grommet access (RG), or center grommet access (CG)

8Q	folkstone grey [A]	+\$0
91	white [A]	+\$0
98	studio white [A]	+\$0
CL	cool grey neutral [A]	+\$0
CN	metallic champagne [A]	+\$0
EH	metallic bronze [A]	+\$0
G1	graphite [A]	+\$0
MS	metallic silver [A]	+\$0
WL	sandstone [A]	+\$0
WN	warm grey neutral [A]	+\$0

Wood Low Credenza, Doors with Drawers

FFC74A
FFC74K

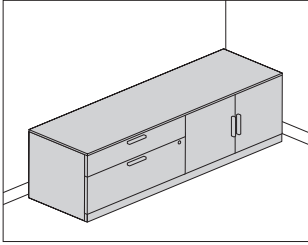

Product Information

Description

This credenza provides enclosed filing and storage and can be used freestanding or to support 1 end of a surface. It has a $\frac{3}{8}$ "-high or $1\frac{1}{4}$ "-high laminate or veneer top with a laminate or veneer case. It is available with 4"-high architectural feet, 4"-high sleeveless architectural feet or a $2\frac{1}{4}$ "-high base with 1" leveling glides and has a positive interlock system that permits only 1 drawer to open at a time. Drawers have full-extension ball-bearing slides. The file drawer accommodates side-to-side and front-to-back filing of letter-, legal, and A4-size hanging files.

Actual credenza widths are $47\frac{3}{4}$ ", $59\frac{3}{4}$ " or $71\frac{3}{4}$ "; actual depth is $19\frac{7}{8}$ ".

Notes

For additional product options, see Vary Easy Program in Appendices.

Arc pull option (A.) conforms to guidelines of Americans with Disabilities Act (ADA).

Grain direction is vertical on veneer and wood-grain laminate fronts.

Storage compartment with door(s) includes 1 adjustable shelf that adjusts in $1\frac{1}{4}$ " increments.

Credenza with 4"-high foot option (4) and $\frac{3}{8}$ " thin top can be used to support a Canvas wall-based frame. Order support bracket, low credenza-to-frame (FT292.) separately.

When using credenza to support 1 end of a surface, order 1 of the following products separately:

- Surface support, low credenza, adjustable height (FT299.)
- Surface support, low credenza, fixed height (FT298.)

To cover adjacent credenzas with a single top, specify credenzas with no top option (NT) and order credenza top (FF890.) separately.

$1\frac{1}{4}$ " top (o6 and o7) is not removable and cannot be used to support a Canvas wall-based frame. The $1\frac{1}{4}$ " top will add $\frac{5}{8}$ " to overall height of unit.

Please note that on the 4" sleeveless architectural foot (5) glides will be more visible.

Order optional wood credenza shelf (FF892.) separately.

To provide temporary guest seating on a credenza, order cushion top (FF891.) separately.

For keyed-alike locks, see Keyed-Alike Information in Appendices.

Dimensions

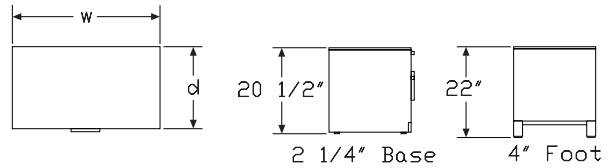

48" Wide

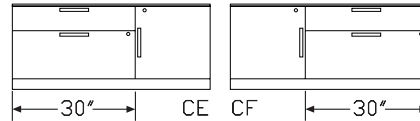

60" Wide

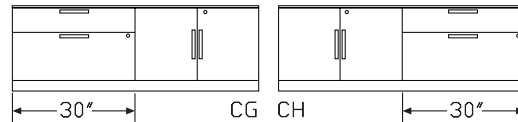

72" Wide

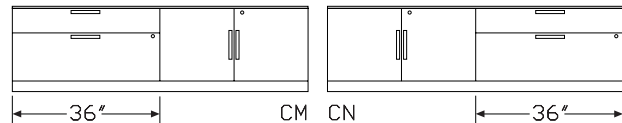

Wood Low Credenza, Doors with Drawers *continued*

Specification Information

Step 1.

FFC74

Step 2. Pull Type

A. arc pull

K. bar pull

Step 3. Width

48 48" wide

60 60" wide

72 72" wide

Step 4. Depth

20 20" deep

Step 5. Base/Foot Height

2 2¹/₄"-high base

4 4"-high foot

5 4" -high foot sleeveless

Step 6. Configuration

For 48" wide (48)

CE 30" box/file left, single door right

CF single door left, 30" box/file right

For 60" wide (60)

CG 30" box/file left, double doors right

CH double doors left, 30" box/file right

For 72" wide (72)

CM 36" box/file left, double doors right

CN double doors left, 36" box/file right

Step 7. Case/Front Material

For 2¹/₄"-high base (2)

L laminate case/front

C laminate case/veneer front

W veneer case/front

For 4"-high foot (4) or 4" -high foot sleeveless (5)

L laminate case/front

C laminate case/veneer front

Step 8. Top

For laminate case/front (L) or laminate case/veneer front (C)

NT no top

03 3/8" laminate top

04 3/8" veneer top

06 1¹/₄" laminate top

07 1¹/₄" veneer top

For veneer case/front (W)

NT no top

04 3/8" veneer top

07 1¹/₄" veneer top

Prices for Steps 1-8.

		2CELNT	2CELO3	2CELO4	2CELO6	2CELO7	2CECNT
FFC74A.	48 20	\$2860	2997	3244	2785	3032	3339
		2CEC03	2CEC04	2CEC06	2CEC07	2CEWNT	2CEW04
FFC74A.	48 20	\$3476	3723	3263	3511	4509	4867
		2CEW07	2CGLNT	2CGL03	2CGL04	2CGL06	2CGL07
FFC74A.	48 20	\$4655	—	—	—	—	—
	60 20	—	\$3270	3435	3708	3223	3496
		2CGCNT	2CGC03	2CGC04	2CGC06	2CGC07	2CGWNT
FFC74A.	60 20	\$3955	4120	4395	3908	4182	5384
		2CGW04	2CGW07	2CMLNT	2CML03	2CML04	2CML06
FFC74A.	60 20	\$5768	5555	—	—	—	—
	72 20	—	—	\$3511	3731	4060	3518
		2CML07	2CMCNT	2CMC03	2CMC04	2CMC06	2CMC07
FFC74A.	72 20	\$3848	4257	4476	4806	4264	4594
		2CMWNT	2CMW04	2CMW07	2CFLNT	2CFL03	2CFL04
FFC74A.	48 20	—	—	—	\$2860	2997	3244
	72 20	\$5883	6266	6054	—	—	—
		2CFL06	2CFL07	2CFCNT	2CFC03	2CFC04	2CFC06
FFC74A.	48 20	\$2785	3032	3339	3476	3723	3263
		2CFC07	2CFWNT	2CFW04	2CFW07	2CHLNT	2CHL03
FFC74A.	48 20	\$3511	4509	4867	4655	—	—
	60 20	—	—	—	—	\$3270	3435

Wood Low Credenza, Doors with Drawers *continued*

Canvas Office Landscape® Wood Case Credenzas

		2CHL04	2CHL06	2CHL07	2CHCNT	2CHC03	2CHC04
FFC74A.	60 20	\$3708	3223	3496	3955	4120	4395
		2CHC06	2CHC07	2CHWNT	2CHW04	2CHW07	2CNLNT
FFC74A.	60 20	\$3908	4182	5384	5768	5555	—
	72 20	—	—	—	—	—	\$3511
		2CNL03	2CNL04	2CNL06	2CNL07	2CNCNT	2CNC03
FFC74A.	72 20	\$3731	4060	3518	3848	4257	4476
		2CNC04	2CNC06	2CNC07	2CNWNT	2CNW04	2CNW07
FFC74A.	72 20	\$4806	4264	4594	5883	6266	6054
		4CELNT	4CEL03	4CEL04	4CEL06	4CEL07	4CECNT
FFC74A.	48 20	\$2997	3134	3381	2922	3169	3472
		4CEC03	4CEC04	4CEC06	4CEC07	4CGLNT	4CGL03
FFC74A.	48 20	\$3608	3855	3395	3643	—	—
	60 20	—	—	—	—	\$3407	3570
		4CGL04	4CGL06	4CGL07	4CGCNT	4CGC03	4CGC04
FFC74A.	60 20	\$3846	3358	3634	4088	4254	4526
		4CGC06	4CGC07	4CMLNT	4CML03	4CML04	4CML06
FFC74A.	60 20	\$4042	4314	—	—	—	—
	72 20	—	—	\$3649	3868	4197	3656
		4CML07	4CMCNT	4CMC03	4CMC04	4CMC06	4CMC07
FFC74A.	72 20	\$3985	4390	4609	4938	4397	4726
		4CFLNT	4CFL03	4CFL04	4CFL06	4CFL07	4CFCNT
FFC74A.	48 20	\$2997	3134	3381	2922	3169	3472
		4CFC03	4CFC04	4CFC06	4CFC07	4CHLNT	4CHL03
FFC74A.	48 20	\$3608	3855	3395	3643	—	—
	60 20	—	—	—	—	\$3407	3570
		4CHL04	4CHL06	4CHL07	4CHCNT	4CHC03	4CHC04
FFC74A.	60 20	\$3846	3358	3634	4088	4254	4526
		4CHC06	4CHC07	4CNLNT	4CNL03	4CNL04	4CNL06
FFC74A.	60 20	\$4042	4314	—	—	—	—
	72 20	—	—	\$3649	3868	4197	3656
		4CNC07	4CNCNT	4CNC03	4CNC04	4CNC06	4CNC07
FFC74A.	72 20	\$3985	4390	4609	4938	4397	4726

		5CELNT	5CELO3	5CELO4	5CELO6	5CELO7	5CECNT
FFC74A.	48 20	\$2944	3081	3329	2869	3117	3419
		5CEC03	5CEC04	5CEC06	5CEC07	5CGLNT	5CGL03
FFC74A.	48 20	\$3555	3802	3343	3590	—	—
	60 20	—	—	—	—	\$3353	3518
		5CGL04	5CGL06	5CGL07	5CGCNT	5CGC03	5CGC04
FFC74A.	60 20	\$3793	3306	3581	4036	4200	4474
		5CGC06	5CGC07	5CMLNT	5CML03	5CML04	5CML06
FFC74A.	60 20	\$3988	4262	—	—	—	—
	72 20	—	—	\$3595	3815	4145	3602
		5CML07	5CMCNT	5CMC03	5CMC04	5CMC06	5CMC07
FFC74A.	72 20	\$3933	4337	4556	4886	4344	4674
		5CFLNT	5CFL03	5CFL04	5CFL06	5CFL07	5CFCNT
FFC74A.	48 20	\$2944	3081	3329	2869	3117	3285
		5CFC03	5CFC04	5CFC06	5CFC07	5CHLNT	5CHL03
FFC74A.	48 20	\$3423	3669	3210	3457	—	—
	60 20	—	—	—	—	\$3353	3518
		5CHL04	5CHL06	5CHL07	5CHCNT	5CHC03	5CHC04
FFC74A.	60 20	\$3793	3306	3581	3902	4067	4342
		5CHC06	5CHC07	5CNLNT	5CNL03	5CNL04	5CNL06
FFC74A.	60 20	\$3855	4129	—	—	—	—
	72 20	—	—	\$3595	3815	4145	3602
		5CNL07	5CNCNT	5CNC03	5CNC04	5CNC06	5CNC07
FFC74A.	72 20	\$3933	4203	4423	4754	4211	4542
		2CELNT	2CELO3	2CELO4	2CELO6	2CELO7	2CECNT
FFC74K.	48 20	\$2860	2997	3244	2785	3032	3339
		2CEC03	2CEC04	2CEC06	2CEC07	2CEWNT	2CEW04
FFC74K.	48 20	\$3476	3723	3263	3511	4509	4867
		2CEW07	2CGLNT	2CGL03	2CGL04	2CGL06	2CGL07
FFC74K.	48 20	\$4655	—	—	—	—	—
	60 20	—	\$3270	3435	3708	3223	3496
		2CGCNT	2CGC03	2CGC04	2CGC06	2CGC07	2CGWNT
FFC74K.	60 20	\$4036	4200	4474	3988	4262	5384

Wood Low Credenza, Doors with Drawers *continued*

	2CGW04	2CGW07	2CMLNT	2CML03	2CML04	2CML06
FFC74K. 60 20	\$5768	5555	—	—	—	—
72 20	—	—	\$3511	3731	4060	3518
	2CML07	2CMCNT	2CMC03	2CMC04	2CMC06	2CMC07
FFC74K. 72 20	\$3848	4257	4476	4806	4264	4594
	2CMWNT	2CMW04	2CMW07	2CFLNT	2CFL03	2CFL04
FFC74K. 48 20	—	—	—	\$2860	2997	3244
72 20	\$5883	6266	6054	—	—	—
	2CFL06	2CFL07	2CFCNT	2CFC03	2CFC04	2CFC06
FFC74K. 48 20	\$2785	3032	3339	3476	3723	3263
	2CFC07	2CFWNT	2CFW04	2CFW07	2CHLNT	2CHL03
FFC74K. 48 20	\$3511	4509	4867	4655	—	—
60 20	—	—	—	—	\$3270	3435
	2CHL04	2CHL06	2CHL07	2CHCNT	2CHC03	2CHC04
FFC74K. 60 20	\$3708	3223	3496	3955	4120	4395
	2CHC06	2CHC07	2CHWNT	2CHW04	2CHW07	2CNLNT
FFC74K. 60 20	\$3908	4182	5384	5768	5555	—
72 20	—	—	—	—	—	\$3511
	2CNL03	2CNL04	2CNL06	2CNL07	2CNCNT	2CNC03
FFC74K. 72 20	\$3731	4060	3518	3848	4257	4476
	2CNC04	2CNC06	2CNC07	2CNWNT	2CNW04	2CNW07
FFC74K. 72 20	\$4806	4264	4594	5883	6266	6054
	4CELNT	4CELO3	4CELO4	4CELO6	4CELO7	4CECNT
FFC74K. 48 20	\$2997	3134	3381	2922	3169	3472
	4CEC03	4CEC04	4CEC06	4CEC07	4CGLNT	4CGL03
FFC74K. 48 20	\$3608	3855	3395	3643	—	—
60 20	—	—	—	—	\$3407	3570
	4CGL04	4CGL06	4CGL07	4CGCNT	4CGC03	4CGC04
FFC74K. 60 20	\$3846	3358	3634	4088	4254	4526
	4CGC06	4CGC07	4CMLNT	4CML03	4CML04	4CML06
FFC74K. 60 20	\$4042	4314	—	—	—	—
72 20	—	—	\$3649	3868	4197	3656
	4CML07	4CMCNT	4CMC03	4CMC04	4CMC06	4CMC07
FFC74K. 72 20	\$3985	4390	4609	4938	4397	4726

	4CFLNT	4CFL03	4CFL04	4CFL06	4CFL07	4CFCNT
FFC74K. 48 20	\$2997	3134	3381	2922	3169	3472
	4CFC03	4CFC04	4CFC06	4CFC07	4CHLNT	4CHL03
FFC74K. 48 20	\$3608	3855	3395	3643	—	—
60 20	—	—	—	—	\$3407	3570
	4CHL04	4CHL06	4CHL07	4CHCNT	4CHC03	4CHC04
FFC74K. 60 20	\$3846	3358	3634	4088	4254	4526
	4CHC06	4CHC07	4CNLNT	4CNL03	4CNL04	4CNL06
FFC74K. 60 20	\$4042	4314	—	—	—	—
72 20	—	—	\$3649	3868	4197	3656
	4CNL07	4CNCNT	4CNC03	4CNC04	4CNC06	4CNC07
FFC74K. 72 20	\$3985	4390	4609	4938	4397	4726
	5CELNT	5CELO3	5CELO4	5CELO6	5CELO7	5CECNT
FFC74K. 48 20	\$2944	3081	3329	2869	3117	3419
	5CEC03	5CEC04	5CEC06	5CEC07	5CGLNT	5CGL03
FFC74K. 48 20	\$3555	3802	3343	3590	—	—
60 20	—	—	—	—	\$3353	3518
	5CGL04	5CGL06	5CGL07	5CGCNT	5CGC03	5CGC04
FFC74K. 60 20	\$3793	3306	3581	3902	4067	4342
	5CGC06	5CGC07	5CMLNT	5CML03	5CML04	5CML06
FFC74K. 60 20	\$3855	4129	—	—	—	—
72 20	—	—	\$3595	3815	4145	3602
	5CML07	5CMCNT	5CMC03	5CMC04	5CMC06	5CMC07
FFC74K. 72 20	\$3933	4337	4556	4886	4344	4674
	5CFLNT	5CFL03	5CFL04	5CFL06	5CFL07	5CFCNT
FFC74K. 48 20	\$2944	3081	3329	2869	3117	3285
	5CFC03	5CFC04	5CFC06	5CFC07	5CHLNT	5CHL03
FFC74K. 48 20	\$3423	3669	3210	3457	—	—
60 20	—	—	—	—	\$3353	3518
	5CHL04	5CHL06	5CHL07	5CHCNT	5CHC03	5CHC04
FFC74K. 60 20	\$3793	3306	3581	3902	4067	4342
	5CHC06	5CHC07	5CNLNT	5CNL03	5CNL04	5CNL06
FFC74K. 60 20	\$3855	4129	—	—	—	—
72 20	—	—	\$3595	3815	4145	3602

Wood Low Credenza, Doors with Drawers *continued*

Canvas Office Landscape® Wood Case Credenzas

5CNC07 5CNCNT 5CNC03 5CNC04 5CNC06 5CNC07

FFC74K. 72 20 \$3933 4203 4423 4754 4211 4542

Step 9. Case Finish

For 48" wide (48) or 60" wide (60) with laminate case/front (L), or laminate case/veneer front (C)

LBM	crisp linen <input type="checkbox"/>	+\$0
LBN	classic linen <input type="checkbox"/>	+\$0
LBP	casual linen <input type="checkbox"/>	+\$0

For 48" wide (48) or 60" wide (60) with laminate case/front (L), or laminate case/veneer front (C)

LBK	pewter mesh <input type="checkbox"/>	+\$0
LBL	steel mesh <input type="checkbox"/>	+\$0

Solid-Color Laminate

For 48" wide (48) or 60" wide (60) with laminate case/front (L), or laminate case/veneer front (C)

8Q	folkstone grey <input type="checkbox"/>	+\$0
91	white <input type="checkbox"/>	+\$0
98	studio white <input type="checkbox"/>	+\$0
CL	cool grey neutral <input type="checkbox"/>	+\$0
LU	soft white <input type="checkbox"/>	+\$0
WL	sandstone <input type="checkbox"/>	+\$0
WN	warm grey neutral <input type="checkbox"/>	+\$0

For 48" wide (48) or 60" wide (60) with laminate case/front (L), or laminate case/veneer front (C)

LBF	neutral twill <input type="checkbox"/>	+\$0
LBG	sarum twill <input type="checkbox"/>	+\$0
LBH	earthen twill <input type="checkbox"/>	+\$0
LBJ	graphite twill <input type="checkbox"/>	+\$0
LBQ	white twill <input type="checkbox"/>	+\$0

Wood-Grain Laminate

For 48" wide (48) or 60" wide (60) with laminate case/front (L), or laminate case/veneer front (C)

LBC	walnut on ash <input type="checkbox"/>	+\$0
LBE	medium red walnut <input type="checkbox"/>	+\$0
HM	natural maple <input type="checkbox"/>	+\$0
HP	light anigre <input type="checkbox"/>	+\$0
LBA	clear on ash <input type="checkbox"/>	+\$0
LBR	phantom ecru <input type="checkbox"/>	+\$0
LBS	phantom cocoa <input type="checkbox"/>	+\$0
LBU	medium matte walnut <input type="checkbox"/>	+\$0
LBV	warm grey teak <input type="checkbox"/>	+\$0
LBB	oak on ash <input type="checkbox"/>	+\$0
LBD	dark brown walnut <input type="checkbox"/>	+\$0
76	light brown walnut <input type="checkbox"/>	+\$0
HX	aged cherry <input type="checkbox"/>	+\$0
HY	walnut on cherry <input type="checkbox"/>	+\$0

For 72" wide (72) with laminate case/front (L), or laminate case/veneer front (C)

LBM	crisp linen <input type="checkbox"/>	+\$0
LBN	classic linen <input type="checkbox"/>	+\$0
LBP	casual linen <input type="checkbox"/>	+\$0

For 72" wide (72) with laminate case/front (L), or laminate case/veneer front (C)

LBK	pewter mesh <input type="checkbox"/>	+\$0
LBL	steel mesh <input type="checkbox"/>	+\$0

Solid-Color Laminate

For 72" wide (72) with laminate case/front (L), or laminate case/veneer front (C)

8Q	folkstone grey <input type="checkbox"/>	+\$0
91	white <input type="checkbox"/>	+\$0
98	studio white <input type="checkbox"/>	+\$0
CL	cool grey neutral <input type="checkbox"/>	+\$0
LU	soft white <input type="checkbox"/>	+\$0
WL	sandstone <input type="checkbox"/>	+\$0
WN	warm grey neutral <input type="checkbox"/>	+\$0

Wood Low Credenza, Doors with Drawers *continued*

Wood Veneer

For veneer case/front (W)

2U	light brown walnut <input type="checkbox"/>	+\$0
40	dark brown walnut <input type="checkbox"/>	+\$0
ED	aged cherry <input type="checkbox"/>	+\$0
EK	medium red walnut <input type="checkbox"/>	+\$0
EW	medium matte walnut <input type="checkbox"/>	+\$0
ET	clear on ash <input type="checkbox"/>	+\$0
EU	oak on ash <input type="checkbox"/>	+\$0
EV	walnut on ash <input type="checkbox"/>	+\$0
UL	natural maple <input type="checkbox"/>	+\$0
UX	walnut on cherry <input type="checkbox"/>	+\$0

Step 10. Front Finish

For laminate case/front (L)

LBM	crisp linen <input type="checkbox"/>	+\$0
LBN	classic linen <input type="checkbox"/>	+\$0
LBP	casual linen <input type="checkbox"/>	+\$0

For laminate case/front (L)

LBK	pewter mesh <input type="checkbox"/>	+\$0
LBL	steel mesh <input type="checkbox"/>	+\$0

Solid-Color Laminate

For laminate case/front (L)

8Q	folkstone grey <input type="checkbox"/>	+\$0
91	white <input type="checkbox"/>	+\$0
98	studio white <input type="checkbox"/>	+\$0
CL	cool grey neutral <input type="checkbox"/>	+\$0
LU	soft white <input type="checkbox"/>	+\$0
WL	sandstone <input type="checkbox"/>	+\$0
WN	warm grey neutral <input type="checkbox"/>	+\$0

For laminate case/front (L)

LBF	neutral twill <input type="checkbox"/>	+\$0
LBG	sarum twill <input type="checkbox"/>	+\$0
LBH	earthen twill <input type="checkbox"/>	+\$0
LBJ	graphite twill <input type="checkbox"/>	+\$0
LBQ	white twill <input type="checkbox"/>	+\$0

Wood-Grain Laminate

For laminate case/front (L)

LBC	walnut on ash <input type="checkbox"/>	+\$0
LBE	medium red walnut <input type="checkbox"/>	+\$0
HM	natural maple <input type="checkbox"/>	+\$0
HP	light anigre <input type="checkbox"/>	+\$0
LBA	clear on ash <input type="checkbox"/>	+\$0
LBR	phantom ecru <input type="checkbox"/>	+\$0
LBS	phantom cocoa <input type="checkbox"/>	+\$0
LBU	medium matte walnut <input type="checkbox"/>	+\$0
LBV	warm grey teak <input type="checkbox"/>	+\$0
LBB	oak on ash <input type="checkbox"/>	+\$0
LBD	dark brown walnut <input type="checkbox"/>	+\$0
76	light brown walnut <input type="checkbox"/>	+\$0
HX	aged cherry <input type="checkbox"/>	+\$0
HY	walnut on cherry <input type="checkbox"/>	+\$0

Wood Veneer

For laminate case/veneer front (C) or veneer case/front (W)

2U	light brown walnut <input type="checkbox"/>	+\$0
40	dark brown walnut <input type="checkbox"/>	+\$0
ED	aged cherry <input type="checkbox"/>	+\$0
EK	medium red walnut <input type="checkbox"/>	+\$0
EW	medium matte walnut <input type="checkbox"/>	+\$0
ET	clear on ash <input type="checkbox"/>	+\$0
EU	oak on ash <input type="checkbox"/>	+\$0
EV	walnut on ash <input type="checkbox"/>	+\$0
UL	natural maple <input type="checkbox"/>	+\$0
UX	walnut on cherry <input type="checkbox"/>	+\$0

Step 11. Top Finish

For 3/8" laminate top (03) or 1 1/4" laminate top (06)

LBM	crisp linen <input type="checkbox"/>	+\$0
LBN	classic linen <input type="checkbox"/>	+\$0
LBP	casual linen <input type="checkbox"/>	+\$0

For 3/8" laminate top (03) or 1 1/4" laminate top (06)

LBK	pewter mesh <input type="checkbox"/>	+\$0
LBL	steel mesh <input type="checkbox"/>	+\$0

Wood Low Credenza, Doors with Drawers *continued*

Solid-Color Laminate

For 3/8" laminate top (03) or 1/4" laminate top (06)

8Q	folkstone grey <input type="checkbox"/>	+\$0
91	white <input type="checkbox"/>	+\$0
98	studio white <input type="checkbox"/>	+\$0
CL	cool grey neutral <input type="checkbox"/>	+\$0
LU	soft white <input type="checkbox"/>	+\$0
WL	sandstone <input type="checkbox"/>	+\$0
WN	warm grey neutral <input type="checkbox"/>	+\$0

For 3/8" laminate top (03) or 1/4" laminate top (06)

LBF	neutral twill <input type="checkbox"/>	+\$0
LBG	sarum twill <input type="checkbox"/>	+\$0
LBH	earthen twill <input type="checkbox"/>	+\$0
LBJ	graphite twill <input type="checkbox"/>	+\$0
LBQ	white twill <input type="checkbox"/>	+\$0

Wood-Grain Laminate

For 3/8" laminate top (03) or 1/4" laminate top (06)

LBC	walnut on ash <input type="checkbox"/>	+\$0
LBE	medium red walnut <input type="checkbox"/>	+\$0
HM	natural maple <input type="checkbox"/>	+\$0
HP	light anigre <input type="checkbox"/>	+\$0
LBA	clear on ash <input type="checkbox"/>	+\$0
LBR	phantom ecru <input type="checkbox"/>	+\$0
LBS	phantom cocoa <input type="checkbox"/>	+\$0
LBU	medium matte walnut <input type="checkbox"/>	+\$0
LBV	warm grey teak <input type="checkbox"/>	+\$0
LBB	oak on ash <input type="checkbox"/>	+\$0
LBD	dark brown walnut <input type="checkbox"/>	+\$0
76	light brown walnut <input type="checkbox"/>	+\$0
HX	aged cherry <input type="checkbox"/>	+\$0
HY	walnut on cherry <input type="checkbox"/>	+\$0

Wood Veneer

For 3/8" veneer top (04) or 1/4" veneer top (07)

2U	light brown walnut <input type="checkbox"/>	+\$0
40	dark brown walnut <input type="checkbox"/>	+\$0
ED	aged cherry <input type="checkbox"/>	+\$0
EK	medium red walnut <input type="checkbox"/>	+\$0
EW	medium matte walnut <input type="checkbox"/>	+\$0
ET	clear on ash <input type="checkbox"/>	+\$0
EU	oak on ash <input type="checkbox"/>	+\$0
EV	walnut on ash <input type="checkbox"/>	+\$0
UL	natural maple <input type="checkbox"/>	+\$0
UX	walnut on cherry <input type="checkbox"/>	+\$0

Step 12. Foot Finish

For 4"-high foot (4) or 4"-high foot sleeveless (5)

8Q	folkstone grey <input type="checkbox"/>	+\$0
98	studio white <input type="checkbox"/>	+\$0
WL	sandstone <input type="checkbox"/>	+\$0
91	white <input type="checkbox"/>	+\$0
CL	cool grey neutral <input type="checkbox"/>	+\$0
G1	graphite <input type="checkbox"/>	+\$0
WN	warm grey neutral <input type="checkbox"/>	+\$0
CN	metallic champagne <input type="checkbox"/>	+\$0
EH	metallic bronze <input type="checkbox"/>	+\$0
MS	metallic silver <input type="checkbox"/>	+\$0

Step 13. Pull Finish

For arc pull (A.)

NH	brushed nickel <input type="checkbox"/>	+\$0
NK	black nickel <input type="checkbox"/>	+\$0

For bar pull (K.)

8Q	folkstone grey	+\$0
91	white	+\$0
98	studio white <input type="checkbox"/>	+\$0
G1	graphite <input type="checkbox"/>	+\$0
WL	sandstone <input type="checkbox"/>	+\$0
CN	metallic champagne <input type="checkbox"/>	+\$0
MS	metallic silver <input type="checkbox"/>	+\$0
79	green apple <input type="checkbox"/>	+\$15
MY3	yellow oxide <input type="checkbox"/>	+\$15
RO	red <input type="checkbox"/>	+\$15
TRQ	turquoise <input type="checkbox"/>	+\$15

Step 14. Counterweight

NO	no counterweight <input type="checkbox"/>	+\$0
CB	counterweight <input type="checkbox"/>	+\$70

Step 15. Lock Option

KA	keyed alike <input type="checkbox"/>	-\$10
KC	keyed differently, chrome <input type="checkbox"/>	+\$0
KD	keyed differently, black <input type="checkbox"/>	+\$0

Wood Low Credenza, Open, FFH700 Height Adjustable Leg Integration

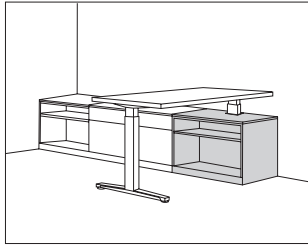

Product Information

Description

This low credenza provides open storage and allows the integration of a height adjustable table leg. It has a $\frac{3}{8}$ "-high or $\frac{1}{4}$ "-high laminate or veneer top with a laminate or veneer case. It is available with 4"-high architectural feet, 4"-high sleeveless architectural feet, or a $2\frac{1}{4}$ "-high base with 1" leveling glides.

Notes

Actual credenza widths are $23\frac{7}{8}$ " (24), $29\frac{7}{8}$ " (30), and $35\frac{7}{8}$ " (36). Actual depths are $14\frac{3}{4}$ " (1), $19\frac{7}{8}$ " (2), and $23\frac{7}{8}$ " (3).

When using height adjustable table cutout (C2, C3, T3, T4) with a perpendicular Renew™ or Motia™ height adjustable table, the depth of surface must align with or be less than credenza width. Order height adjustable Renew or Motia table separately.

For use with Renew standard electric range (E) and no power access option in leg (NNP), or Motia standard electric range (E). Order separately.

Height adjustable table is always positioned perpendicular to credenza. Table surface will have a 1" gap at back edge of table and 2" gap at back of low credenza.

When placing a height adjustable table in this credenza, an obstruction sensor (DUSG) is required. Order separately. See Canvas Private Office Enhancements Product and Planning Document on Omni for more information.

Grain direction is vertical on veneer and wood-grain laminate.

Credenza includes 1 adjustable shelf that adjusts in $\frac{1}{4}$ " increments.

Credenza with 4"-high foot (4) option and $\frac{3}{8}$ " thin top (3 or 4) can be used to support a Canvas Wall frame. Order support bracket, low credenza-to-frame (FT292.) separately.

Credenza with 4"-high foot (4) option and $\frac{3}{8}$ " thin top (3 or 4) can be used to support a Canvas Dock. Order support bracket, low credenza-to-dock (FD292.) separately.

$\frac{1}{4}$ " top (6 and 7) is not removable and cannot be used to support a Canvas Wall frame. $\frac{1}{4}$ " top adds $\frac{5}{8}$ " to overall height of unit.

Note that on the 4" sleeveless architectural foot (5) the glides will be more visible.

For view of and access to power and the architectural wall, order partial height, for wall access (P) inner panel height. Order full height (F) inner panel when view of wall is not needed.

For additional product options, see Vary Easy Program in appendices.

Dimensions

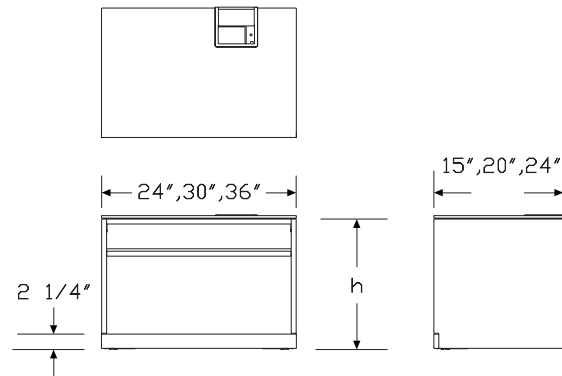

Wood Low Credenza, Open, Height Adjustable Leg Integration

continued

Canvas Office Landscape® Wood Case Credenzas

Specification Information		
Step 1.		
FFH700. <input type="checkbox"/>		
Step 2. Width		
24	24" wide <input type="checkbox"/>	+\$1332
30	30" wide <input type="checkbox"/>	+\$1448
36	36" wide <input type="checkbox"/>	+\$1563
Step 3. Depth		
1	15" deep <input type="checkbox"/>	+\$0
2	20" deep <input type="checkbox"/>	+\$0
3	24" deep <input type="checkbox"/>	+\$0
Step 4. Base/Foot Height		
2	2 1/4"-high base <input type="checkbox"/>	+\$100
4	4"-high foot <input type="checkbox"/>	+\$200
5	4"-high foot sleeveless <input type="checkbox"/>	+\$150
Step 5. Orientation		
L	storage left, integrated leg left <input type="checkbox"/>	+\$0
R	storage right, integrated leg right <input type="checkbox"/>	+\$0
Step 6. Table Integration		
<i>For 24" wide (24)</i>		
C2	cutout for use with C-Leg and 24" D surface <input type="checkbox"/>	+\$0
<i>For 30" wide (30)</i>		
C2	cutout for use with C-Leg and 24" D surface <input type="checkbox"/>	+\$0
C3	cutout for use with C-Leg and 30" D surface <input type="checkbox"/>	+\$0
T3	cutout for use with T-Leg and 30" D surface <input type="checkbox"/>	+\$0
<i>For 36" wide (36)</i>		
C2	cutout for use with C-Leg and 24" D surface <input type="checkbox"/>	+\$0
C3	cutout for use with C-Leg and 30" D surface <input type="checkbox"/>	+\$0
T3	cutout for use with T-Leg and 30" D surface <input type="checkbox"/>	+\$0
T4	cutout for use with T-Leg and 36" D surface <input type="checkbox"/>	+\$0
Step 7. Inner Panel Height		
F	full-height <input type="checkbox"/>	+\$50
P	partial height, for wall access <input type="checkbox"/>	+\$35

Step 8. Back Panel Type		
<i>For 4"-high foot (4) or 4"-high foot sleeveless (5)</i>		
F	full height, removable back <input type="checkbox"/>	+\$50
N	no back <input type="checkbox"/>	+\$0
<i>For 2 1/4"-high base (2)</i>		
N	no back <input type="checkbox"/>	+\$0
Step 9. Case/Base Material		
<i>For 2 1/4"-high base (2)</i>		
L	laminated case <input type="checkbox"/>	+\$0
C	laminated case/veneer base <input type="checkbox"/>	+\$400
W	veneer case <input type="checkbox"/>	+\$2400
<i>For 4"-high foot (4) or 4"-high foot sleeveless (5)</i>		
L	laminated case <input type="checkbox"/>	+\$0
W	veneer case <input type="checkbox"/>	+\$0
W	veneer case <input type="checkbox"/>	+\$2000
Step 10. Top		
3	3/8" laminate top <input type="checkbox"/>	+\$150
4	3/8" veneer top <input type="checkbox"/>	+\$300
6	1 1/4" laminate top <input type="checkbox"/>	+\$300
7	1 1/4" veneer <input type="checkbox"/>	+\$600

Wood Low Credenza, Open, Height Adjustable Leg Integration

continued

Step 11. Case/Edge Finish

For laminate case (L) or laminate case/veneer base (C)

76	light brown walnut <input type="checkbox"/>	+\$0
8Q	folkstone grey <input type="checkbox"/>	+\$0
91	white <input type="checkbox"/>	+\$0
98	studio white <input type="checkbox"/>	+\$0
CL	cool grey neutral <input type="checkbox"/>	+\$0
HM	natural maple <input type="checkbox"/>	+\$0
HP	light anigre <input type="checkbox"/>	+\$0
HX	aged cherry <input type="checkbox"/>	+\$0
HY	walnut on cherry <input type="checkbox"/>	+\$0
LA	light ash <input type="checkbox"/>	+\$0
LBA	clear on ash <input type="checkbox"/>	+\$0
LBB	oak on ash <input type="checkbox"/>	+\$0
LBC	walnut on ash <input type="checkbox"/>	+\$0
LBD	dark brown walnut <input type="checkbox"/>	+\$0
LBE	medium red walnut <input type="checkbox"/>	+\$0
LBF	neutral twill <input type="checkbox"/>	+\$0
LBG	sarum twill <input type="checkbox"/>	+\$0
LBH	earthen twill <input type="checkbox"/>	+\$0
LBJ	graphite twill <input type="checkbox"/>	+\$0
LBK	pewter mesh <input type="checkbox"/>	+\$0
LBL	steel mesh <input type="checkbox"/>	+\$0
LBM	crisp linen <input type="checkbox"/>	+\$0
LBN	classic linen <input type="checkbox"/>	+\$0
LBP	casual linen <input type="checkbox"/>	+\$0
LBQ	white twill <input type="checkbox"/>	+\$0
LBR	phantom ecru <input type="checkbox"/>	+\$0
LBS	phantom cocoa <input type="checkbox"/>	+\$0
LBU	medium matte walnut <input type="checkbox"/>	+\$0
LBV	warm grey teak <input type="checkbox"/>	+\$0
LU	soft white <input type="checkbox"/>	+\$0
WL	sandstone <input type="checkbox"/>	+\$0
WN	warm grey neutral <input type="checkbox"/>	+\$0

Wood Veneer

For veneer case (W)

2U	light brown walnut <input type="checkbox"/>	+\$0
40	dark brown walnut <input type="checkbox"/>	+\$0
ED	aged cherry <input type="checkbox"/>	+\$0
EK	medium red walnut <input type="checkbox"/>	+\$0
EW	medium matte walnut <input type="checkbox"/>	+\$0
ET	clear on ash <input type="checkbox"/>	+\$0
EU	oak on ash <input type="checkbox"/>	+\$0
EV	walnut on ash <input type="checkbox"/>	+\$0
UL	natural maple <input type="checkbox"/>	+\$0
UX	walnut on cherry <input type="checkbox"/>	+\$0

Wood Low Credenza, Open, Height Adjustable Leg Integration

continued

Canvas Office Landscape® Wood Case Credenzas

Step 12. Base/Edge Finish

For laminate case (L)

76	light brown walnut <input type="checkbox"/>	+\$0
8Q	folkstone grey <input type="checkbox"/>	+\$0
91	white <input type="checkbox"/>	+\$0
98	studio white <input type="checkbox"/>	+\$0
CL	cool grey neutral <input type="checkbox"/>	+\$0
HM	natural maple <input type="checkbox"/>	+\$0
HP	light anigre <input type="checkbox"/>	+\$0
HX	aged cherry <input type="checkbox"/>	+\$0
HY	walnut on cherry <input type="checkbox"/>	+\$0
LA	light ash <input type="checkbox"/>	+\$0
LBA	clear on ash <input type="checkbox"/>	+\$0
LBB	oak on ash <input type="checkbox"/>	+\$0
LBC	walnut on ash <input type="checkbox"/>	+\$0
LBD	dark brown walnut <input type="checkbox"/>	+\$0
LBE	medium red walnut <input type="checkbox"/>	+\$0
LBF	neutral twill <input type="checkbox"/>	+\$0
LBG	sarum twill <input type="checkbox"/>	+\$0
LBH	earthen twill <input type="checkbox"/>	+\$0
LBJ	graphite twill <input type="checkbox"/>	+\$0
LBK	pewter mesh <input type="checkbox"/>	+\$0
LBL	steel mesh <input type="checkbox"/>	+\$0
LBM	crisp linen <input type="checkbox"/>	+\$0
LBN	classic linen <input type="checkbox"/>	+\$0
LBP	casual linen <input type="checkbox"/>	+\$0
LBQ	white twill <input type="checkbox"/>	+\$0
LBR	phantom ecru <input type="checkbox"/>	+\$0
LBS	phantom cocoa <input type="checkbox"/>	+\$0
LBU	medium matte walnut <input type="checkbox"/>	+\$0
LBV	warm grey teak <input type="checkbox"/>	+\$0
LU	soft white <input type="checkbox"/>	+\$0
WL	sandstone <input type="checkbox"/>	+\$0
WN	warm grey neutral <input type="checkbox"/>	+\$0

For laminate case/veneer base (C) or veneer case (W)

2U	light brown walnut <input type="checkbox"/>	+\$0
40	dark brown walnut <input type="checkbox"/>	+\$0
ED	aged cherry <input type="checkbox"/>	+\$0
EK	medium red walnut <input type="checkbox"/>	+\$0
EW	medium matte walnut <input type="checkbox"/>	+\$0
ET	clear on ash <input type="checkbox"/>	+\$0
EU	oak on ash <input type="checkbox"/>	+\$0
EV	walnut on ash <input type="checkbox"/>	+\$0
UL	natural maple <input type="checkbox"/>	+\$0
UX	walnut on cherry <input type="checkbox"/>	+\$0

Step 13. Top/Edge Finish

For 3¹/₈" laminate top (3)

76	light brown walnut <input type="checkbox"/>	+\$0
8Q	folkstone grey <input type="checkbox"/>	+\$0
91	white <input type="checkbox"/>	+\$0
98	studio white <input type="checkbox"/>	+\$0
CL	cool grey neutral <input type="checkbox"/>	+\$0
HM	natural maple <input type="checkbox"/>	+\$0
HP	light anigre <input type="checkbox"/>	+\$0
HX	aged cherry <input type="checkbox"/>	+\$0
HY	walnut on cherry <input type="checkbox"/>	+\$0
LA	light ash <input type="checkbox"/>	+\$0
LBA	clear on ash <input type="checkbox"/>	+\$0
LBB	oak on ash <input type="checkbox"/>	+\$0
LBC	walnut on ash <input type="checkbox"/>	+\$0
LBD	dark brown walnut <input type="checkbox"/>	+\$0
LBE	medium red walnut <input type="checkbox"/>	+\$0
LBF	neutral twill <input type="checkbox"/>	+\$0
LBG	sarum twill <input type="checkbox"/>	+\$0
LBH	earthen twill <input type="checkbox"/>	+\$0
LBJ	graphite twill <input type="checkbox"/>	+\$0
LBK	pewter mesh <input type="checkbox"/>	+\$0
LBL	steel mesh <input type="checkbox"/>	+\$0
LBM	crisp linen <input type="checkbox"/>	+\$0
LBN	classic linen <input type="checkbox"/>	+\$0
LBP	casual linen <input type="checkbox"/>	+\$0
LBQ	white twill <input type="checkbox"/>	+\$0
LBR	phantom ecru <input type="checkbox"/>	+\$0
LBS	phantom cocoa <input type="checkbox"/>	+\$0
LBU	medium matte walnut <input type="checkbox"/>	+\$0
LBV	warm grey teak <input type="checkbox"/>	+\$0
LU	soft white <input type="checkbox"/>	+\$0
WL	sandstone <input type="checkbox"/>	+\$0
WN	warm grey neutral <input type="checkbox"/>	+\$0

For 1¹/₄" laminate top (6)

76	light brown walnut <input type="checkbox"/>	+\$0
8Q	folkstone grey <input type="checkbox"/>	+\$0
91	white <input type="checkbox"/>	+\$0
98	studio white <input type="checkbox"/>	+\$0
CL	cool grey neutral <input type="checkbox"/>	+\$0
HF	inner tone light <input type="checkbox"/>	+\$0
HM	natural maple <input type="checkbox"/>	+\$0
HP	light anigre <input type="checkbox"/>	+\$0
HT	inner tone <input type="checkbox"/>	+\$0
HX	aged cherry <input type="checkbox"/>	+\$0

Wood Low Credenza, Open, Height Adjustable Leg Integration

continued

HY	walnut on cherry <input type="checkbox"/>	+\$0
LA	light ash <input type="checkbox"/>	+\$0
LBA	clear on ash <input type="checkbox"/>	+\$0
LBR	phantom ecru <input type="checkbox"/>	+\$0
LBS	phantom cocoa <input type="checkbox"/>	+\$0
LBU	medium matte walnut <input type="checkbox"/>	+\$0
LBV	warm grey teak <input type="checkbox"/>	+\$0
LBB	oak on ash <input type="checkbox"/>	+\$0
LBC	walnut on ash <input type="checkbox"/>	+\$0
LBD	dark brown walnut <input type="checkbox"/>	+\$0
LBE	medium red walnut <input type="checkbox"/>	+\$0
LBF	neutral twill <input type="checkbox"/>	+\$0
LBG	sarum twill <input type="checkbox"/>	+\$0
LBH	earthen twill <input type="checkbox"/>	+\$0
LBJ	graphite twill <input type="checkbox"/>	+\$0
LBK	pewter mesh <input type="checkbox"/>	+\$0
LBL	steel mesh <input type="checkbox"/>	+\$0
LBM	crisp linen <input type="checkbox"/>	+\$0
LBN	classic linen <input type="checkbox"/>	+\$0
LBP	casual linen <input type="checkbox"/>	+\$0
LBQ	white twill <input type="checkbox"/>	+\$0
LM	mahogany <input type="checkbox"/>	+\$0
LT	light tone <input type="checkbox"/>	+\$0
LU	soft white <input type="checkbox"/>	+\$0
MT	medium tone <input type="checkbox"/>	+\$0
WL	sandstone <input type="checkbox"/>	+\$0
WN	warm grey neutral <input type="checkbox"/>	+\$0

Wood Veneer

For $\frac{3}{8}$ " veneer top (4) or $1\frac{1}{4}$ " veneer (7)

2U	light brown walnut <input type="checkbox"/>	+\$0
40	dark brown walnut <input type="checkbox"/>	+\$0
ED	aged cherry <input type="checkbox"/>	+\$0
EK	medium red walnut <input type="checkbox"/>	+\$0
EW	medium matte walnut <input type="checkbox"/>	+\$0
ET	clear on ash <input type="checkbox"/>	+\$0
EU	oak on ash <input type="checkbox"/>	+\$0
EV	walnut on ash <input type="checkbox"/>	+\$0
UL	natural maple <input type="checkbox"/>	+\$0
UX	walnut on cherry <input type="checkbox"/>	+\$0

Step 14. Foot Finish

For 4"-high foot (4) or 4"-high foot sleeveless (5)

8Q	folkstone grey <input type="checkbox"/>	+\$0
98	studio white <input type="checkbox"/>	+\$0
WL	sandstone <input type="checkbox"/>	+\$0
91	white <input type="checkbox"/>	+\$0
CL	cool grey neutral <input type="checkbox"/>	+\$0
G1	graphite <input type="checkbox"/>	+\$0
WN	warm grey neutral <input type="checkbox"/>	+\$0
CN	metallic champagne <input type="checkbox"/>	+\$0
EH	metallic bronze <input type="checkbox"/>	+\$0
MS	metallic silver <input type="checkbox"/>	+\$0

Step 15. Grommet Finish

8Q	folkstone grey <input type="checkbox"/>	+\$0
91	white <input type="checkbox"/>	+\$0
98	studio white <input type="checkbox"/>	+\$0
CL	cool grey neutral <input type="checkbox"/>	+\$0
CN	metallic champagne <input type="checkbox"/>	+\$0
EH	metallic bronze <input type="checkbox"/>	+\$0
G1	graphite <input type="checkbox"/>	+\$0
MS	metallic silver <input type="checkbox"/>	+\$0
WL	sandstone <input type="checkbox"/>	+\$0
WN	warm grey neutral <input type="checkbox"/>	+\$0

Wood Low Credenza, Open, Power Access

FFV700

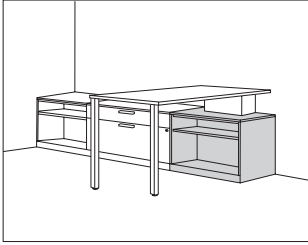

Product Information

Description

This low power access credenza provides open storage and allows the integration of power within the credenza. It has a $\frac{3}{8}$ "-high or $\frac{1}{4}$ "-high laminate or veneer top with a laminate or veneer case. It is available with 4"-high architectural feet, 4"-high sleeveless architectural feet, or a $2\frac{1}{4}$ "-high base with 1" leveling glides.

Notes

Actual power access credenza widths are $23\frac{7}{8}$ " (24), $29\frac{7}{8}$ " (30), and $35\frac{7}{8}$ " (36). Actual depth is $19\frac{7}{8}$ " (20).

Credenza includes 1 adjustable shelf that adjusts in $\frac{1}{4}$ " increments.

Grain direction is vertical on veneer and wood-grain laminate.

When using stanchion cutout (S2, S3, S4) with a perpendicular surface, depth of surface must be equal to, or less than, width of credenza.

Order rectangular surface (FTS10.) or rectangular surface, peninsula end (FTS34.) separately. Surface leg support must be outbound.

Surface must be field cut out to match the grommet mounted electrical distributor cutout requirements.

When using credenza to support 1 end of a surface, order the following product separately:

- Fixed surface support, low credenza, power chase (FV298.)

Order the following products separately:

- Logic G1000 grommet mounted electrical distributor (Y1425.D or .G) separately.

Center (CG) grommet access is available to route power cords through top of low credenza to power access on the wall. Specify no top cutout (NC) when access is not needed on top of surface.

For view of and access to power and the architectural wall, specify partial height, for wall access (P) inner panel height option. Specify full height (F) inner panel when view of wall is not needed.

For additional product options, see Vary Easy Program in appendices.

Dimensions

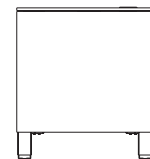
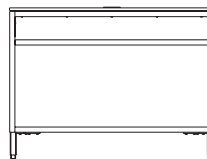
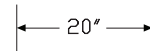
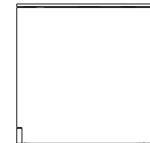
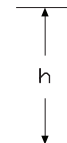
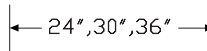
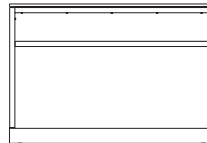
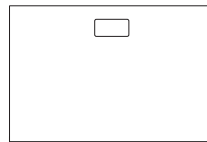

Wood Low Credenza, Open,
Power Access *continued*

Specification Information

Step 1.

FFV700. A

Step 2. Width

24	24" wide <input type="checkbox"/> A	+\$941
30	30" wide <input type="checkbox"/> A	+\$1060
36	36" wide <input type="checkbox"/> A	+\$1179

Step 3. Depth

20	20" deep <input type="checkbox"/> A	+\$0
-----------	-------------------------------------	------

Step 4. Base/Foot Height

2	2 1/4"-high base <input type="checkbox"/> A	+\$100
4	4"-high foot <input type="checkbox"/> A	+\$200
5	4" -high foot sleeveless <input type="checkbox"/> A	+\$150

Step 5. Orientation

L	storage left of user <input type="checkbox"/> A	+\$0
R	storage right of user <input type="checkbox"/> A	+\$0

Step 6. Top Power Access

For 24" wide (24)

NC	no top cutout <input type="checkbox"/> A	+\$0
S2	stanchion cutout, for use with a 24" deep surface <input type="checkbox"/> A	+\$0
CG	center grommet access <input type="checkbox"/> A	+\$0

For 30" wide (30)

NC	no top cutout <input type="checkbox"/> A	+\$0
S2	stanchion cutout, for use with a 24" deep surface <input type="checkbox"/> A	+\$0
S3	stanchion cutout, for use with a 30" deep surface <input type="checkbox"/> A	+\$0
CG	center grommet access <input type="checkbox"/> A	+\$0

For 36" wide (36)

NC	no top cutout <input type="checkbox"/> A	+\$0
S2	stanchion cutout, for use with a 24" deep surface <input type="checkbox"/> A	+\$0
S3	stanchion cutout, for use with a 30" deep surface <input type="checkbox"/> A	+\$0
S4	stanchion cutout, for use with a 36" deep surface <input type="checkbox"/> A	+\$0
CG	center grommet access <input type="checkbox"/> A	+\$0

Step 7. Inner Panel Height

For stanchion cutout, for use with a 24" deep surface (S2), stanchion cutout, for use with a 30" deep surface (S3), stanchion cutout, for use with a 36" deep surface (S4), or center grommet access (CG)

F	full-height <input type="checkbox"/> A	+\$50
P	partial height, for wall access <input type="checkbox"/> A	+\$35

For no top cutout (NC)

P	partial height, for wall access <input type="checkbox"/> A	+\$35
----------	--	-------

Step 8. Back Panel Type

For 4"-high foot (4) or 4" -high foot sleeveless (5)

F	full height, removable back <input type="checkbox"/> A	+\$50
N	no back <input type="checkbox"/> A	+\$0

For 2 1/4"-high base (2)

N	no back <input type="checkbox"/> A	+\$0
----------	------------------------------------	------

Step 9. Case/Base Material

For 2 1/4"-high base (2)

L	laminate case <input type="checkbox"/> A	+\$0
C	laminate case/veneer base <input type="checkbox"/> A	+\$400
W	veneer case <input type="checkbox"/> A	+\$2200

For 4"-high foot (4) or 4" -high foot sleeveless (5)

L	laminate case <input type="checkbox"/> A	+\$0
W	veneer case <input type="checkbox"/> A	+\$1800

Step 10. Top

3	3/8" laminate top <input type="checkbox"/> A	+\$150
4	3/8" veneer top <input type="checkbox"/> A	+\$300
6	1 1/4" laminate top <input type="checkbox"/> A	+\$300
7	1 1/4" veneer top <input type="checkbox"/> A	+\$600

Wood Low Credenza, Open, Power Access *continued*

Step 11. Case/Edge Finish

For laminate case (L) or laminate case/veneer base (C)

76	light brown walnut <input type="checkbox"/>	+\$0
8Q	folkstone grey <input type="checkbox"/>	+\$0
91	white <input type="checkbox"/>	+\$0
98	studio white <input type="checkbox"/>	+\$0
CL	cool grey neutral <input type="checkbox"/>	+\$0
HM	natural maple <input type="checkbox"/>	+\$0
HP	light anigre <input type="checkbox"/>	+\$0
HX	aged cherry <input type="checkbox"/>	+\$0
HY	walnut on cherry <input type="checkbox"/>	+\$0
LA	light ash <input type="checkbox"/>	+\$0
LBA	clear on ash <input type="checkbox"/>	+\$0
LBB	oak on ash <input type="checkbox"/>	+\$0
LBC	walnut on ash <input type="checkbox"/>	+\$0
LBD	dark brown walnut <input type="checkbox"/>	+\$0
LBE	medium red walnut <input type="checkbox"/>	+\$0
LBF	neutral twill <input type="checkbox"/>	+\$0
LBG	sarum twill <input type="checkbox"/>	+\$0
LBH	earthen twill <input type="checkbox"/>	+\$0
LBJ	graphite twill <input type="checkbox"/>	+\$0
LBK	pewter mesh <input type="checkbox"/>	+\$0
LBL	steel mesh <input type="checkbox"/>	+\$0
LBM	crisp linen <input type="checkbox"/>	+\$0
LBN	classic linen <input type="checkbox"/>	+\$0
LBP	casual linen <input type="checkbox"/>	+\$0
LBQ	white twill <input type="checkbox"/>	+\$0
LBR	phantom ecru <input type="checkbox"/>	+\$0
LBS	phantom cocoa <input type="checkbox"/>	+\$0
LBU	medium matte walnut <input type="checkbox"/>	+\$0
LBV	warm grey teak <input type="checkbox"/>	+\$0
LU	soft white <input type="checkbox"/>	+\$0
WL	sandstone <input type="checkbox"/>	+\$0
WN	warm grey neutral <input type="checkbox"/>	+\$0

Wood Veneer

For veneer case (W)

2U	light brown walnut <input type="checkbox"/>	+\$0
40	dark brown walnut <input type="checkbox"/>	+\$0
ED	aged cherry <input type="checkbox"/>	+\$0
EK	medium red walnut <input type="checkbox"/>	+\$0
EW	medium matte walnut <input type="checkbox"/>	+\$0
ET	clear on ash <input type="checkbox"/>	+\$0
EU	oak on ash <input type="checkbox"/>	+\$0
EV	walnut on ash <input type="checkbox"/>	+\$0
UL	natural maple <input type="checkbox"/>	+\$0
UX	walnut on cherry <input type="checkbox"/>	+\$0

Wood Low Credenza, Open, Power Access *continued*

Step 12. Base/Edge Finish

For laminate case (L)

76	light brown walnut <input type="checkbox"/>	+\$0
8Q	folkstone grey <input type="checkbox"/>	+\$0
91	white <input type="checkbox"/>	+\$0
98	studio white <input type="checkbox"/>	+\$0
CL	cool grey neutral <input type="checkbox"/>	+\$0
HM	natural maple <input type="checkbox"/>	+\$0
HP	light anigre <input type="checkbox"/>	+\$0
HX	aged cherry <input type="checkbox"/>	+\$0
HY	walnut on cherry <input type="checkbox"/>	+\$0
LA	light ash <input type="checkbox"/>	+\$0
LBA	clear on ash <input type="checkbox"/>	+\$0
LBB	oak on ash <input type="checkbox"/>	+\$0
LBC	walnut on ash <input type="checkbox"/>	+\$0
LBD	dark brown walnut <input type="checkbox"/>	+\$0
LBE	medium red walnut <input type="checkbox"/>	+\$0
LBF	neutral twill <input type="checkbox"/>	+\$0
LBG	sarum twill <input type="checkbox"/>	+\$0
LBH	earthen twill <input type="checkbox"/>	+\$0
LBJ	graphite twill <input type="checkbox"/>	+\$0
LBK	pewter mesh <input type="checkbox"/>	+\$0
LBL	steel mesh <input type="checkbox"/>	+\$0
LBM	crisp linen <input type="checkbox"/>	+\$0
LBN	classic linen <input type="checkbox"/>	+\$0
LBP	casual linen <input type="checkbox"/>	+\$0
LBQ	white twill <input type="checkbox"/>	+\$0
LBR	phantom ecru <input type="checkbox"/>	+\$0
LBS	phantom cocoa <input type="checkbox"/>	+\$0
LBU	medium matte walnut <input type="checkbox"/>	+\$0
LBV	warm grey teak <input type="checkbox"/>	+\$0
LU	soft white <input type="checkbox"/>	+\$0
WL	sandstone <input type="checkbox"/>	+\$0
WN	warm grey neutral <input type="checkbox"/>	+\$0

For laminate case/veneer base (C) or veneer case (W)

2U	light brown walnut <input type="checkbox"/>	+\$0
40	dark brown walnut <input type="checkbox"/>	+\$0
ED	aged cherry <input type="checkbox"/>	+\$0
EK	medium red walnut <input type="checkbox"/>	+\$0
EW	medium matte walnut <input type="checkbox"/>	+\$0
ET	clear on ash <input type="checkbox"/>	+\$0
EU	oak on ash <input type="checkbox"/>	+\$0
EV	walnut on ash <input type="checkbox"/>	+\$0
UL	natural maple <input type="checkbox"/>	+\$0
UX	walnut on cherry <input type="checkbox"/>	+\$0

Step 13. Top/Edge Finish

For 3/8" laminate top (3) or 1 1/4" laminate top (6)

76	light brown walnut <input type="checkbox"/>	+\$0
8Q	folkstone grey <input type="checkbox"/>	+\$0
91	white <input type="checkbox"/>	+\$0
98	studio white <input type="checkbox"/>	+\$0
CL	cool grey neutral <input type="checkbox"/>	+\$0
HM	natural maple <input type="checkbox"/>	+\$0
HP	light anigre <input type="checkbox"/>	+\$0
HX	aged cherry <input type="checkbox"/>	+\$0
HY	walnut on cherry <input type="checkbox"/>	+\$0
LA	light ash <input type="checkbox"/>	+\$0
LBA	clear on ash <input type="checkbox"/>	+\$0
LBB	oak on ash <input type="checkbox"/>	+\$0
LBC	walnut on ash <input type="checkbox"/>	+\$0
LBD	dark brown walnut <input type="checkbox"/>	+\$0
LBE	medium red walnut <input type="checkbox"/>	+\$0
LBF	neutral twill <input type="checkbox"/>	+\$0
LBG	sarum twill <input type="checkbox"/>	+\$0
LBH	earthen twill <input type="checkbox"/>	+\$0
LBJ	graphite twill <input type="checkbox"/>	+\$0
LBK	pewter mesh <input type="checkbox"/>	+\$0
LBL	steel mesh <input type="checkbox"/>	+\$0
LBM	crisp linen <input type="checkbox"/>	+\$0
LBN	classic linen <input type="checkbox"/>	+\$0
LBP	casual linen <input type="checkbox"/>	+\$0
LBQ	white twill <input type="checkbox"/>	+\$0
LBR	phantom ecru <input type="checkbox"/>	+\$0
LBS	phantom cocoa <input type="checkbox"/>	+\$0
LBU	medium matte walnut <input type="checkbox"/>	+\$0
LBV	warm grey teak <input type="checkbox"/>	+\$0
LU	soft white <input type="checkbox"/>	+\$0
WL	sandstone <input type="checkbox"/>	+\$0
WN	warm grey neutral <input type="checkbox"/>	+\$0

Wood Low Credenza, Open, Power Access *continued*

Wood Veneer

For 3/8" veneer top (4) or 1 1/4" veneer top (7)

2U	light brown walnut <input type="checkbox"/>	+\$0
40	dark brown walnut <input type="checkbox"/>	+\$0
ED	aged cherry <input type="checkbox"/>	+\$0
EK	medium red walnut <input type="checkbox"/>	+\$0
EW	medium matte walnut <input type="checkbox"/>	+\$0
ET	clear on ash <input type="checkbox"/>	+\$0
EU	oak on ash <input type="checkbox"/>	+\$0
EV	walnut on ash <input type="checkbox"/>	+\$0
UL	natural maple <input type="checkbox"/>	+\$0
UX	walnut on cherry <input type="checkbox"/>	+\$0

Step 14. Foot Finish

For 4"-high foot (4) or 4"-high foot sleeveless (5)

8Q	folkstone grey <input type="checkbox"/>	+\$0
98	studio white <input type="checkbox"/>	+\$0
WL	sandstone <input type="checkbox"/>	+\$0
91	white <input type="checkbox"/>	+\$0
CL	cool grey neutral <input type="checkbox"/>	+\$0
G1	graphite <input type="checkbox"/>	+\$0
WN	warm grey neutral <input type="checkbox"/>	+\$0
CN	metallic champagne <input type="checkbox"/>	+\$0
EH	metallic bronze <input type="checkbox"/>	+\$0
MS	metallic silver <input type="checkbox"/>	+\$0

Step 15. Grommet Finish

For center grommet access (CG)

8Q	folkstone grey <input type="checkbox"/>	+\$0
91	white <input type="checkbox"/>	+\$0
98	studio white <input type="checkbox"/>	+\$0
CL	cool grey neutral <input type="checkbox"/>	+\$0
CN	metallic champagne <input type="checkbox"/>	+\$0
EH	metallic bronze <input type="checkbox"/>	+\$0
G1	graphite <input type="checkbox"/>	+\$0
MS	metallic silver <input type="checkbox"/>	+\$0
WL	sandstone <input type="checkbox"/>	+\$0
WN	warm grey neutral <input type="checkbox"/>	+\$0

Wood High Credenza, Open with Access to Power FFV800

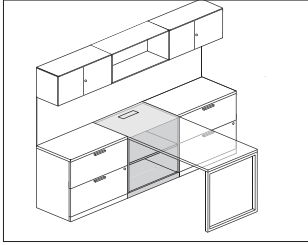

Product Information

Description

This power access credenza provides open storage and can be used freestanding or to support 1 end of a peninsula surface. It has a $\frac{3}{8}$ "-high or $1\frac{1}{4}$ "-high laminate or veneer top with a laminate or veneer case. It is available with a $2\frac{1}{4}$ " base with 1" leveling glides.

Notes

Actual power access credenza widths are $23\frac{7}{8}$ " (24), $29\frac{7}{8}$ " (30), and $35\frac{7}{8}$ " (36). Actual depth is $19\frac{7}{8}$ " (20).

Credenza has no center divider and includes 1 adjustable shelf that adjusts in $1\frac{1}{4}$ " increments.

Grain direction is vertical on veneer and wood-grain laminate.

Order Canvas $1\frac{1}{4}$ " thick peninsula surface, rectangular end (FTS34.) separately.

The cutout is optimized for use with a Logic G1000 grommet mounted electrical distributor 5-wide (Y1425.C or F) or 6-wide (Y1425.D or G) unit. Attaching surface must be field cut to match the grommet electrical distributor cutout requirements.

For view of and access to power and the architectural wall, specify partial height, for wall access (P) inner panel height option. Specify full height (F) inner panel when view of wall is not needed.

For additional product options, see Vary Easy Program in appendices.

Dimensions

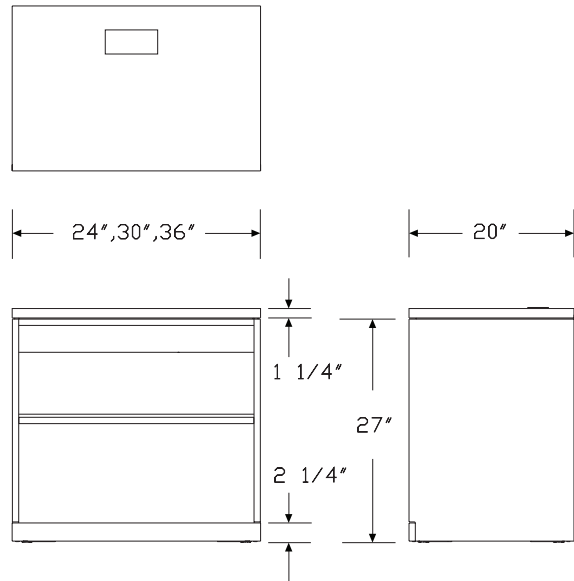

Wood High Credenza, Open with Access to Power *continued*

Specification Information

Step 1.

FFV800.

Step 2. Width

24	24" wide <input type="checkbox"/>	+\$1531
30	30" wide <input type="checkbox"/>	+\$1600
36	36" wide <input type="checkbox"/>	+\$1668

Step 3. Depth

20	20" deep <input type="checkbox"/>	+\$0
-----------	-----------------------------------	------

Step 4. Base Height

2	2 1/4"-high base <input type="checkbox"/>	+\$100
----------	---	--------

Step 5. Top Power Access

NC	no top, with power access cutout for use with 1-1/4" surface <input type="checkbox"/>	+\$0
-----------	---	------

Step 6. Inner Panel Height

F	full height <input type="checkbox"/>	+\$50
P	partial height, for wall access <input type="checkbox"/>	+\$30

Step 7. Case/Base Material

L	laminate case <input type="checkbox"/>	+\$0
C	laminate case/veneer base <input type="checkbox"/>	+\$400
W	veneer case <input type="checkbox"/>	+\$1900

Step 8. Case/Edge Finish

For laminate case (L) or laminate case/veneer base (C)

76	light brown walnut <input type="checkbox"/>	+\$0
8Q	folkstone grey <input type="checkbox"/>	+\$0
91	white <input type="checkbox"/>	+\$0
98	studio white <input type="checkbox"/>	+\$0
CL	cool grey neutral <input type="checkbox"/>	+\$0
HM	natural maple <input type="checkbox"/>	+\$0
HP	light anigre <input type="checkbox"/>	+\$0
HX	aged cherry <input type="checkbox"/>	+\$0
HY	walnut on cherry <input type="checkbox"/>	+\$0
LA	light ash <input type="checkbox"/>	+\$0
LBA	clear on ash <input type="checkbox"/>	+\$0
LBR	phantom ecru <input type="checkbox"/>	+\$0
LBS	phantom cocoa <input type="checkbox"/>	+\$0
LBU	medium matte walnut <input type="checkbox"/>	+\$0
LBV	warm grey teak <input type="checkbox"/>	+\$0
LBB	oak on ash <input type="checkbox"/>	+\$0
LBC	walnut on ash <input type="checkbox"/>	+\$0
LBD	dark brown walnut <input type="checkbox"/>	+\$0
LBE	medium red walnut <input type="checkbox"/>	+\$0
LBF	neutral twill <input type="checkbox"/>	+\$0
LBG	sarum twill <input type="checkbox"/>	+\$0
LBH	earthen twill <input type="checkbox"/>	+\$0
LBJ	graphite twill <input type="checkbox"/>	+\$0
LBK	pewter mesh <input type="checkbox"/>	+\$0
LBL	steel mesh <input type="checkbox"/>	+\$0
LBM	crisp linen <input type="checkbox"/>	+\$0
LBN	classic linen <input type="checkbox"/>	+\$0
LBP	casual linen <input type="checkbox"/>	+\$0
LBQ	white twill <input type="checkbox"/>	+\$0
LU	soft white <input type="checkbox"/>	+\$0
WL	sandstone <input type="checkbox"/>	+\$0
WN	warm grey neutral <input type="checkbox"/>	+\$0

For veneer case (W)

2U	light brown walnut <input type="checkbox"/>	+\$0
40	dark brown walnut <input type="checkbox"/>	+\$0
ED	aged cherry <input type="checkbox"/>	+\$0
EK	medium red walnut <input type="checkbox"/>	+\$0
EW	medium matte walnut <input type="checkbox"/>	+\$0
ET	clear on ash <input type="checkbox"/>	+\$0
EU	oak on ash <input type="checkbox"/>	+\$0
EV	walnut on ash <input type="checkbox"/>	+\$0
UL	natural maple <input type="checkbox"/>	+\$0
UX	walnut on cherry <input type="checkbox"/>	+\$0

Wood High Credenza, Open with Access to Power *continued*

Step 9. Base Finish

For laminate case (L)

LBU	medium matte walnut <input type="checkbox"/>	+\$0
76	light brown walnut <input type="checkbox"/>	+\$0
8Q	folkstone grey <input type="checkbox"/>	+\$0
91	white <input type="checkbox"/>	+\$0
98	studio white <input type="checkbox"/>	+\$0
CL	cool grey neutral <input type="checkbox"/>	+\$0
HM	natural maple <input type="checkbox"/>	+\$0
HP	light anigre <input type="checkbox"/>	+\$0
HX	aged cherry <input type="checkbox"/>	+\$0
HY	walnut on cherry <input type="checkbox"/>	+\$0
LA	light ash <input type="checkbox"/>	+\$0
LBA	clear on ash <input type="checkbox"/>	+\$0
LBB	oak on ash <input type="checkbox"/>	+\$0
LBC	walnut on ash <input type="checkbox"/>	+\$0
LBD	dark brown walnut <input type="checkbox"/>	+\$0
LBE	medium red walnut <input type="checkbox"/>	+\$0
LBF	neutral twill <input type="checkbox"/>	+\$0
LBG	sarum twill <input type="checkbox"/>	+\$0
LBH	earthen twill <input type="checkbox"/>	+\$0
LBJ	graphite twill <input type="checkbox"/>	+\$0
LBK	pewter mesh <input type="checkbox"/>	+\$0
LBL	steel mesh <input type="checkbox"/>	+\$0
LBM	crisp linen <input type="checkbox"/>	+\$0
LBN	classic linen <input type="checkbox"/>	+\$0
LBP	casual linen <input type="checkbox"/>	+\$0
LBQ	white twill <input type="checkbox"/>	+\$0
LU	soft white <input type="checkbox"/>	+\$0
WL	sandstone <input type="checkbox"/>	+\$0
WN	warm grey neutral <input type="checkbox"/>	+\$0

For laminate case/veneer base (C) or veneer case (W)

2U	light brown walnut <input type="checkbox"/>	+\$0
40	dark brown walnut <input type="checkbox"/>	+\$0
ED	aged cherry <input type="checkbox"/>	+\$0
EK	medium red walnut <input type="checkbox"/>	+\$0
EW	medium matte walnut <input type="checkbox"/>	+\$0
ET	clear on ash <input type="checkbox"/>	+\$0
EU	oak on ash <input type="checkbox"/>	+\$0
EV	walnut on ash <input type="checkbox"/>	+\$0
UL	natural maple <input type="checkbox"/>	+\$0
UX	walnut on cherry <input type="checkbox"/>	+\$0

Wood High Credenza, Open

FF800.

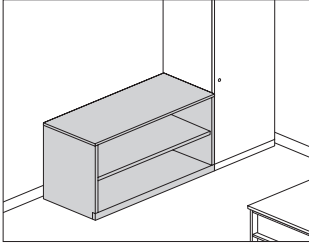

Canvas Office Landscape® Wood Case Credenzas

Product Information

Description

This freestanding credenza provides open storage. It has a $\frac{3}{8}$ "-high laminate or veneer top and a laminate or veneer case. The credenza has a $2\frac{1}{4}$ "-high base with 1" leveling glides.

Actual credenza widths are $29\frac{7}{8}$ ", $35\frac{7}{8}$ ", or $41\frac{7}{8}$ "; actual depth is $19\frac{7}{8}$ ".

Notes

For additional product options, see Vary Easy Program in Appendices.

30"- and 36"-wide credenzas have no center divider and 1 adjustable shelf. 42"-wide credenza has a center divider and 2 adjustable shelves. Shelves adjust in $\frac{1}{4}$ " increments.

Order optional wood credenza shelf (FF892.) separately.

To cover adjacent credenzas with a single top, specify credenzas with no top option (NT) and order credenza top (FF890.) separately.

No top (NT) option includes spacer kit that creates $\frac{1}{4}$ " reveal between the top of a wood pedestal, lateral file, or high credenza and a $\frac{1}{4}$ "-thick worksurface placed at $28\frac{1}{4}$ " high. Worksurface ordered separately.

Dimensions

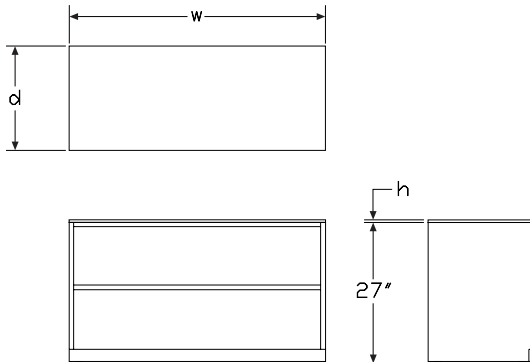

Specification Information

Step 1.

FF800. A

Step 2. Width

30 30" wide A

36 36" wide A

42 42" wide A

Step 3. Depth

20 20" deep A

Step 4. Base Height

2 $2\frac{1}{4}$ "-high base A

Step 5. Case/Base Material

L laminate A

C laminate case/veneer base A

W veneer A

Step 6. Top

For laminate (L) or laminate case/veneer base (C)

NT no top A

03 $\frac{3}{8}$ " laminate top A

04 $\frac{3}{8}$ " veneer top A

For veneer (W)

NT no top A

04 $\frac{3}{8}$ " veneer top A

Prices for Steps 1-6.

	2LNT	2L03	2L04	2CNT	2C03	2C04
FF800. 30 20	\$1528	1639	1859	1693	1803	2023
36 20	\$1623	1733	1954	1789	1899	2118
42 20	\$1637	1746	1966	1801	1910	2130

	2WNT	2W04
FF800. 30 20	\$2638	2981
36 20	\$2812	3154
42 20	\$2834	3177

Wood High Credenza, Open *continued*

Step 7. Case Finish

Solid-Color Laminate

For laminate (L) or laminate case/veneer base (C)

8Q	folkstone grey <input type="checkbox"/>	+\$0
91	white <input type="checkbox"/>	+\$0
98	studio white	+\$0
CL	cool grey neutral <input type="checkbox"/>	+\$0
LU	soft white <input type="checkbox"/>	+\$0
WL	sandstone <input type="checkbox"/>	+\$0
WN	warm grey neutral <input type="checkbox"/>	+\$0

Linen Laminate

For laminate (L) or laminate case/veneer base (C)

LBM	crisp linen	+\$0
LBN	classic linen	+\$0
LBP	casual linen	+\$0

Mesh Laminate

For laminate (L) or laminate case/veneer base (C)

LBK	pewter mesh	+\$0
LBL	steel mesh	+\$0

Twill Laminate

For laminate (L) or laminate case/veneer base (C)

LBF	neutral twill	+\$0
LBG	sarum twill	+\$0
LBH	earthen twill	+\$0
LBJ	graphite twill	+\$0
LBQ	white twill	+\$0

Wood-Grain Laminate

For laminate (L) or laminate case/veneer base (C)

HM	natural maple <input type="checkbox"/>	+\$0
HP	light anigre <input type="checkbox"/>	+\$0
LBA	clear on ash	+\$0
LBR	phantom ecru	+\$0
LBS	phantom cocoa	+\$0
LBU	medium matte walnut	+\$0
LBV	warm grey teak	+\$0
LBB	oak on ash	+\$0
LBC	walnut on ash	+\$0
LBD	dark brown walnut	+\$0
LBE	medium red walnut	+\$0
76	light brown walnut <input type="checkbox"/>	+\$0
HX	aged cherry <input type="checkbox"/>	+\$0
HY	walnut on cherry <input type="checkbox"/>	+\$0

Wood Veneer

For veneer (W)

2U	light brown walnut <input type="checkbox"/>	+\$0
40	dark brown walnut <input type="checkbox"/>	+\$0
ED	aged cherry <input type="checkbox"/>	+\$0
EK	medium red walnut <input type="checkbox"/>	+\$0
EW	medium matte walnut <input type="checkbox"/>	+\$0
ET	clear on ash <input type="checkbox"/>	+\$0
EU	oak on ash <input type="checkbox"/>	+\$0
EV	walnut on ash <input type="checkbox"/>	+\$0
UL	natural maple <input type="checkbox"/>	+\$0
UX	walnut on cherry <input type="checkbox"/>	+\$0

Step 8. Top Finish

Solid-Color Laminate

For 3/8" laminate top (03)

8Q	folkstone grey <input type="checkbox"/>	+\$0
91	white <input type="checkbox"/>	+\$0
98	studio white	+\$0
CL	cool grey neutral <input type="checkbox"/>	+\$0
LU	soft white <input type="checkbox"/>	+\$0
WL	sandstone <input type="checkbox"/>	+\$0
WN	warm grey neutral <input type="checkbox"/>	+\$0

Linen Laminate

For 3/8" laminate top (03)

LBM	crisp linen	+\$0
LBN	classic linen	+\$0
LBP	casual linen	+\$0

Mesh Laminate

For 3/8" laminate top (03)

LBK	pewter mesh	+\$0
LBL	steel mesh	+\$0

Twill Laminate

For 3/8" laminate top (03)

LBF	neutral twill	+\$0
LBG	sarum twill	+\$0
LBH	earthen twill	+\$0
LBJ	graphite twill	+\$0
LBQ	white twill	+\$0

Wood High Credenza, Open *continued*

Wood-Grain Laminate

For 3/8" laminate top (o3)

HM	natural maple A	+\$0
HP	light anigre A	+\$0
LBA	clear on ash	+\$0
LBR	phantom ecru	+\$0
LBS	phantom cocoa	+\$0
LBU	medium matte walnut	+\$0
LBV	warm grey teak	+\$0
LBB	oak on ash	+\$0
LBC	walnut on ash	+\$0
LBD	dark brown walnut	+\$0
LBE	medium red walnut	+\$0
76	light brown walnut A	+\$0
HX	aged cherry A	+\$0
HY	walnut on cherry A	+\$0

Wood Veneer

For 3/8" veneer top (o4)

2U	light brown walnut A	+\$0
40	dark brown walnut A	+\$0
ED	aged cherry A	+\$0
EK	medium red walnut A	+\$0
EW	medium matte walnut A	+\$0
ET	clear on ash A	+\$0
EU	oak on ash A	+\$0
EV	walnut on ash A	+\$0
UL	natural maple A	+\$0
UX	walnut on cherry A	+\$0

Step 9. Base Finish

Solid-Color Laminate

For laminate (L)

8Q	folkstone grey A	+\$0
91	white A	+\$0
98	studio white	+\$0
CL	cool grey neutral A	+\$0
LU	soft white A	+\$0
WL	sandstone A	+\$0
WN	warm grey neutral A	+\$0

Linen Laminate

For laminate (L)

LBM	crisp linen	+\$0
LBN	classic linen	+\$0
LBP	casual linen	+\$0

Mesh Laminate

For laminate (L)

LBK	pewter mesh	+\$0
LBL	steel mesh	+\$0

Twill Laminate

For laminate (L)

LBF	neutral twill	+\$0
LBG	sarum twill	+\$0
LBH	earthen twill	+\$0
LBJ	graphite twill	+\$0
LBQ	white twill	+\$0

Wood-Grain Laminate

For laminate (L)

HM	natural maple A	+\$0
HP	light anigre A	+\$0
LBA	clear on ash	+\$0
LBR	phantom ecru	+\$0
LBS	phantom cocoa	+\$0
LBU	medium matte walnut	+\$0
LBV	warm grey teak	+\$0
LBB	oak on ash	+\$0
LBC	walnut on ash	+\$0
LBD	dark brown walnut	+\$0
LBE	medium red walnut	+\$0
76	light brown walnut A	+\$0
HX	aged cherry A	+\$0
HY	walnut on cherry A	+\$0

Wood Veneer

For laminate case/veneer base (C) or veneer (W)

2U	light brown walnut A	+\$0
40	dark brown walnut A	+\$0
ED	aged cherry A	+\$0
EK	medium red walnut A	+\$0
EW	medium matte walnut A	+\$0
ET	clear on ash A	+\$0
EU	oak on ash A	+\$0
EV	walnut on ash A	+\$0
UL	natural maple A	+\$0
UX	walnut on cherry A	+\$0

Wood High Credenza, with Doors

continued

Canvas Office Landscape® Wood Case Credenzas

42 20						\$3965	4306
	2LNTL	2L03L	2L04L	2CNTL	2C03L	2C04L	
FF81K. 30 20	\$1910	2021	2240	2064	2174	2393	
36 20	\$2103	2213	2432	2294	2404	2624	
42 20	\$2295	2405	2625	2525	2634	2853	
				2WNTL	2W04L		
FF81K. 30 20				\$3301	3640		
36 20				\$3633	3972		
42 20				\$3965	4306		

Step 9. Case Finish

Solid-Color Laminate

For laminate (L) or laminate case/veneer door (C)

8Q	folkstone grey <input type="checkbox"/>	+\$0
91	white <input type="checkbox"/>	+\$0
98	studio white	+\$0
CL	cool grey neutral <input type="checkbox"/>	+\$0
LU	soft white <input type="checkbox"/>	+\$0
WL	sandstone <input type="checkbox"/>	+\$0
WN	warm grey neutral <input type="checkbox"/>	+\$0

Linen Laminate

For laminate (L) or laminate case/veneer door (C)

LBM	crisp linen	+\$0
LBN	classic linen	+\$0
LBP	casual linen	+\$0

Mesh Laminate

For laminate (L) or laminate case/veneer door (C)

LBK	pewter mesh	+\$0
LBL	steel mesh	+\$0

Twill Laminate

For laminate (L) or laminate case/veneer door (C)

LBF	neutral twill	+\$0
LBG	sarum twill	+\$0
LBH	earthen twill	+\$0
LBJ	graphite twill	+\$0
LBQ	white twill	+\$0

Wood-Grain Laminate

For laminate (L) or laminate case/veneer door (C)

HM	natural maple <input type="checkbox"/>	+\$0
HP	light anigre <input type="checkbox"/>	+\$0
LBA	clear on ash	+\$0
LBR	phantom ecru	+\$0
LBS	phantom cocoa	+\$0
LBU	medium matte walnut	+\$0
LBV	warm grey teak	+\$0
LBB	oak on ash	+\$0
LBC	walnut on ash	+\$0
LBD	dark brown walnut	+\$0
LBE	medium red walnut	+\$0
76	light brown walnut <input type="checkbox"/>	+\$0
HX	aged cherry <input type="checkbox"/>	+\$0
HY	walnut on cherry <input type="checkbox"/>	+\$0

Wood Veneer

For veneer (W)

2U	light brown walnut <input type="checkbox"/>	+\$0
40	dark brown walnut <input type="checkbox"/>	+\$0
ED	aged cherry <input type="checkbox"/>	+\$0
EK	medium red walnut <input type="checkbox"/>	+\$0
EW	medium matte walnut <input type="checkbox"/>	+\$0
ET	clear on ash <input type="checkbox"/>	+\$0
EU	oak on ash <input type="checkbox"/>	+\$0
EV	walnut on ash <input type="checkbox"/>	+\$0
UL	natural maple <input type="checkbox"/>	+\$0
UX	walnut on cherry <input type="checkbox"/>	+\$0

Step 10. Door Finish

Solid-Color Laminate

For laminate (L)

8Q	folkstone grey <input type="checkbox"/>	+\$0
91	white <input type="checkbox"/>	+\$0
98	studio white	+\$0
CL	cool grey neutral <input type="checkbox"/>	+\$0
LU	soft white <input type="checkbox"/>	+\$0
WL	sandstone <input type="checkbox"/>	+\$0
WN	warm grey neutral <input type="checkbox"/>	+\$0

Linen Laminate

For laminate (L)

LBM	crisp linen	+\$0
LBN	classic linen	+\$0
LBP	casual linen	+\$0

Wood High Credenza, with Doors

continued

Mesh Laminate

For laminate (L)

LBK	pewter mesh	+\$0
LBL	steel mesh	+\$0

Twill Laminate

For laminate (L)

LBF	neutral twill	+\$0
LBG	sarum twill	+\$0
LBH	earthen twill	+\$0
LBJ	graphite twill	+\$0
LBQ	white twill	+\$0

Wood-Grain Laminate

For laminate (L)

HM	natural maple A	+\$0
HP	light anigre A	+\$0
LBA	clear on ash	+\$0
LBR	phantom ecru	+\$0
LBS	phantom cocoa	+\$0
LBU	medium matte walnut	+\$0
LBV	warm grey teak	+\$0
LBB	oak on ash	+\$0
LBC	walnut on ash	+\$0
LBD	dark brown walnut	+\$0
LBE	medium red walnut	+\$0
76	light brown walnut A	+\$0
HX	aged cherry A	+\$0
HY	walnut on cherry A	+\$0

Wood Veneer

For laminate case/veneer door (C) or veneer (W)

2U	light brown walnut A	+\$0
40	dark brown walnut A	+\$0
ED	aged cherry A	+\$0
EK	medium red walnut A	+\$0
EW	medium matte walnut A	+\$0
ET	clear on ash A	+\$0
EU	oak on ash A	+\$0
EV	walnut on ash A	+\$0
UL	natural maple A	+\$0
UX	walnut on cherry A	+\$0

Step 11. Top Finish

Solid-Color Laminate

For 3/8" laminate top (03)

8Q	folkstone grey A	+\$0
91	white A	+\$0
98	studio white	+\$0
CL	cool grey neutral A	+\$0
LU	soft white A	+\$0
WL	sandstone A	+\$0
WN	warm grey neutral A	+\$0

Linen Laminate

For 3/8" laminate top (03)

LBM	crisp linen	+\$0
LBN	classic linen	+\$0
LBP	casual linen	+\$0

Mesh Laminate

For 3/8" laminate top (03)

LBK	pewter mesh	+\$0
LBL	steel mesh	+\$0

Twill Laminate

For 3/8" laminate top (03)

LBF	neutral twill	+\$0
LBG	sarum twill	+\$0
LBH	earthen twill	+\$0
LBJ	graphite twill	+\$0
LBQ	white twill	+\$0

Wood-Grain Laminate

For 3/8" laminate top (03)

HM	natural maple A	+\$0
HP	light anigre A	+\$0
LBA	clear on ash	+\$0
LBR	phantom ecru	+\$0
LBS	phantom cocoa	+\$0
LBU	medium matte walnut	+\$0
LBV	warm grey teak	+\$0
LBB	oak on ash	+\$0
LBC	walnut on ash	+\$0
LBD	dark brown walnut	+\$0
LBE	medium red walnut	+\$0
76	light brown walnut A	+\$0
HX	aged cherry A	+\$0
HY	walnut on cherry A	+\$0

Wood High Credenza, with Doors

continued

Canvas Office Landscape® Wood Case Credenzas

Wood Veneer

For $\frac{3}{8}$ " veneer top (04)

2U	light brown walnut <input type="checkbox"/>	+\$0
40	dark brown walnut <input type="checkbox"/>	+\$0
ED	aged cherry <input type="checkbox"/>	+\$0
EK	medium red walnut <input type="checkbox"/>	+\$0
EW	medium matte walnut <input type="checkbox"/>	+\$0
ET	clear on ash <input type="checkbox"/>	+\$0
EU	oak on ash <input type="checkbox"/>	+\$0
EV	walnut on ash <input type="checkbox"/>	+\$0
UL	natural maple <input type="checkbox"/>	+\$0
UX	walnut on cherry <input type="checkbox"/>	+\$0

Step 12. Pull Finish

For arc pull (A.)

NH	brushed nickel <input type="checkbox"/>	+\$0
NK	black nickel <input type="checkbox"/>	+\$0

For bar pull (K.)

8Q	folkstone grey	+\$0
91	white	+\$0
98	studio white <input type="checkbox"/>	+\$0
G1	graphite <input type="checkbox"/>	+\$0
WL	sandstone <input type="checkbox"/>	+\$0
CN	metallic champagne <input type="checkbox"/>	+\$0
MS	metallic silver <input type="checkbox"/>	+\$0
79	green apple <input type="checkbox"/>	+\$15
MY3	yellow oxide <input type="checkbox"/>	+\$15
RO	red <input type="checkbox"/>	+\$15
TRQ	turquoise <input type="checkbox"/>	+\$15

Step 13. Lock Option

KA	keyed alike <input type="checkbox"/>	-\$10
KC	keyed differently, chrome <input type="checkbox"/>	+\$0
KD	keyed differently, black <input type="checkbox"/>	+\$0

Support Bracket, Low Credenza-to-Frame

FT292.

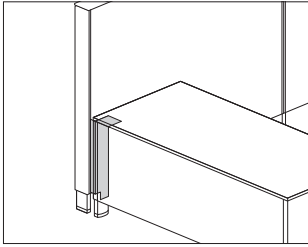

Product Information

Description

This bracket attaches between a Canvas wood or metal credenza and a frame. It allows the credenza to attach parallel or perpendicular to the frame, providing support to a frame run in place of a return wall or work surface support.

Notes

Bracket attaches credenza with no gap or with a 1" gap from the front of the frame to allow room for cords and cables.

Support bracket attaches to low credenza with 4" foot only.

Support bracket also attaches to back of a 60" wide or wider low credenza where 2 units are joined.

Support bracket orientation (left or right) is determined by the frame orientation as you are facing the frame. Credenza can be attached parallel or perpendicular to a frame. Bracket attaches to the back left or back right of the low credenza.

Dimensions

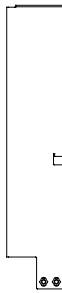
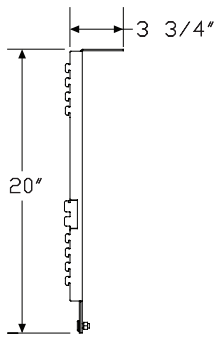
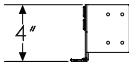

Specification Information

Step 1.

FT292.

Step 2. Storage Type

M for use with metal low credenza with 4" high foot

C for use with wood low credenza with 4" high foot **A**

Step 3. Frame Attachment Location

L left end of frame

R right end of frame

Step 4. Storage Attachment Position

N no gap, for storage tight to wall

G 1" gap, for cord drop

Prices for Steps 1-4.

		N	G
FT292.	M L	\$129	129
	R	\$129	129
	C L	\$129	129
	R	\$129	129

Step 5. Surface Finish

Bright Sand Texture Paint

91	white	+\$0
CL	cool grey neutral	+\$0
G1	graphite	+\$0
WN	warm grey neutral	+\$0
8Q	folkstone grey	+\$0
98	studio white	+\$0
WL	sandstone	+\$0

Metallic Paint

CN	metallic champagne	+\$0
EH	metallic bronze	+\$0
MS	metallic silver	+\$0

Thick Top, 27" High Wood Storage

FF888.

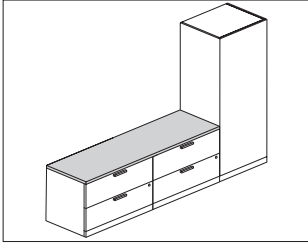

Product Information

Description

This 1 1/4" laminate or veneer square edge top attaches to 27"-high wood storage units and is used to cover up to 2 units ganged side-by-side.

Notes

Thick top depth matches depth of lower storage below it. Actual depths are 19 7/8" (20) and 23 7/8" (24).

Thick top can cover 1 or a maximum of 2 27"-high wood storage units.

Specify top width to match total width of all units covered.

For use with the following lower storage units with no top (NT) option:

- Wood freestanding lateral file (FF20)
- Wood freestanding pedestal with file/file or box/box/file configurations (FF10x.xxFF, FF10x.xxBBF)
- Wood high credenza, with doors (FF81)
- Wood high credenza, open (FF800)

This top is required for attaching a storage-attached hutch:

- Bookcase hutch, storage attached (FV454.)
- Hutch, partial enclosure, storage attached (FV456.)

Dimensions

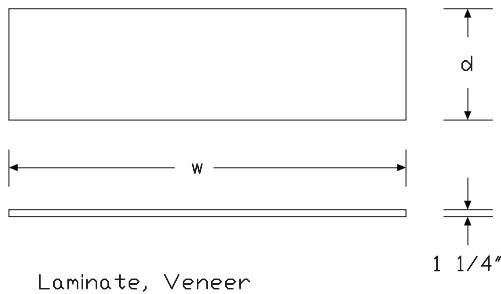

Specification Information

Step 1.

FF888. A

Step 2. Depth

20 20" deep A

24 24" deep A

Step 3. Configuration

01 one unit placed under the storage top A

02 two units placed under the storage top A

Step 4. Width

For one unit placed under the storage top (01)

16 15 5/8" wide A

30 30" wide A

36 36" wide A

42 42" wide A

For two units placed under the storage top (02)

46 46" wide A

52 52" wide A

58 58" wide A

60 60" wide A

66 66" wide A

72 72" wide A

78 78" wide A

84 84" wide A

Step 5. Surface Material

L laminate top/thermoplastic edge A

U laminate top/universal edge A

W veneer top/veneer edge A

Prices for Steps 1-5.

	16L	16U	16W	30L	30U	30W
FF888. 20 01	\$135	135	458	158	158	511
24 01	\$135	135	458	158	158	511
	36L	36U	36W	42L	42U	42W
FF888. 20 01	\$183	183	561	207	207	613
24 01	\$183	183	561	207	207	613
	46L	46U	46W	52L	52U	52W
FF888. 20 02	\$221	221	634	259	259	703
24 02	\$221	221	634	259	259	703

Thick Top, 27" High Wood Storage *continued*

	58L	58U	58W	60L	60U	60W
FF888. 20 02	\$303	303	793	309	309	823
24 02	\$303	303	793	309	309	823

	66L	66U	66W	72L	72U	72W
FF888. 20 02	\$350	350	914	392	392	1002
24 02	\$350	350	914	392	392	1002

	78L	78U	78W	84L	84U	84W
FF888. 20 02	\$443	443	1096	497	497	1144
24 02	\$443	443	1096	497	497	1144

Step 6.

Top Finish

For laminate top/thermoplastic edge (L) or laminate top/universal edge (U)

76	light brown walnut	A	+\$0
8Q	folkstone grey	A	+\$0
91	white	A	+\$0
98	studio white	A	+\$0
CL	cool grey neutral	A	+\$0
HF	inner tone light	A	+\$0
HM	natural maple	A	+\$0
HP	light anigre	A	+\$0
HT	inner tone	A	+\$0
HX	aged cherry	A	+\$0
HY	walnut on cherry	A	+\$0
LA	light ash	A	+\$0
LBA	clear on ash	A	+\$0
LBB	oak on ash	A	+\$0
LBC	walnut on ash	A	+\$0
LBD	dark brown walnut	A	+\$0
LBE	medium red walnut	A	+\$0
LBF	neutral twill	A	+\$0
LBG	sarum twill	A	+\$0
LBH	earthen twill	A	+\$0
LBJ	graphite twill	A	+\$0
LBK	pewter mesh	A	+\$0
LBL	steel mesh	A	+\$0
LBM	crisp linen	A	+\$0
LBN	classic linen	A	+\$0
LBP	casual linen	A	+\$0
LBQ	white twill	A	+\$0
LM	mahogany	A	+\$0
LT	light tone	A	+\$0
LU	soft white	A	+\$0
MT	medium tone	A	+\$0
WL	sandstone	A	+\$0
WN	warm grey neutral	A	+\$0

Thick Top, 27" High Wood Storage *continued*

Top/Edge Finish

For veneer top/veneer edge (W)

2U	light brown walnut <input type="checkbox"/>	+\$0
40	dark brown walnut <input type="checkbox"/>	+\$0
ED	aged cherry <input type="checkbox"/>	+\$0
EK	medium red walnut <input type="checkbox"/>	+\$0
ET	clear on ash <input type="checkbox"/>	+\$0
EU	oak on ash <input type="checkbox"/>	+\$0
EV	walnut on ash <input type="checkbox"/>	+\$0
EW	medium matte walnut <input type="checkbox"/>	+\$0
UL	natural maple <input type="checkbox"/>	+\$0
UX	walnut on cherry <input type="checkbox"/>	+\$0

Step 7. Edge Finish

For laminate top/thermoplastic edge (L)

76	light brown walnut <input type="checkbox"/>	+\$0
8Q	folkstone grey <input type="checkbox"/>	+\$0
91	white <input type="checkbox"/>	+\$0
98	studio white <input type="checkbox"/>	+\$0
BU	black umber <input type="checkbox"/>	+\$0
CL	cool grey neutral <input type="checkbox"/>	+\$0
HF	inner tone light <input type="checkbox"/>	+\$0
HM	natural maple <input type="checkbox"/>	+\$0
HP	light anigre <input type="checkbox"/>	+\$0
HT	inner tone <input type="checkbox"/>	+\$0
HX	aged cherry <input type="checkbox"/>	+\$0
HY	walnut on cherry <input type="checkbox"/>	+\$0
LA	light ash <input type="checkbox"/>	+\$0
LBA	clear on ash <input type="checkbox"/>	+\$0
LBB	oak on ash <input type="checkbox"/>	+\$0
LBC	walnut on ash <input type="checkbox"/>	+\$0
LBD	dark brown walnut <input type="checkbox"/>	+\$0
LBE	medium red walnut <input type="checkbox"/>	+\$0
LBF	neutral twill <input type="checkbox"/>	+\$0
LBG	sarum twill <input type="checkbox"/>	+\$0
LBH	earthen twill <input type="checkbox"/>	+\$0
LBJ	graphite twill <input type="checkbox"/>	+\$0
LBK	pewter mesh <input type="checkbox"/>	+\$0
LBL	steel mesh <input type="checkbox"/>	+\$0
LBM	crisp linen <input type="checkbox"/>	+\$0
LBN	classic linen <input type="checkbox"/>	+\$0
LBP	casual linen <input type="checkbox"/>	+\$0
LBQ	white twill <input type="checkbox"/>	+\$0
LBU	medium matte walnut <input type="checkbox"/>	+\$0
LU	soft white <input type="checkbox"/>	+\$0
MT	medium tone <input type="checkbox"/>	+\$0
WL	sandstone <input type="checkbox"/>	+\$0
WN	warm grey neutral <input type="checkbox"/>	+\$0

For laminate top/universal edge (U)

PLY	plywood edge <input type="checkbox"/>	+\$50
------------	---------------------------------------	-------

Credenza Top for Wood Credenza, FF889.
with Pari Screen, Storage
Attached

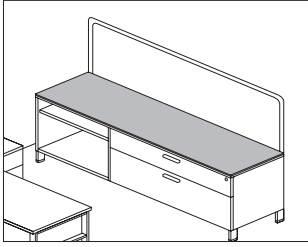

Product Information

Description

This 3/8"-high laminate or veneer credenza top covers a single credenza or 2 credenzas ganged side by side. Thin top has predrilled holes to accommodate Pari screen attachment bayonets. Thin top attachment hardware included.

Notes

Order Pari screen (FV360.) separately.
Specify thin top width to match overall width of credenza.
For configuration information, see Pari Screen planning guide.

Dimensions

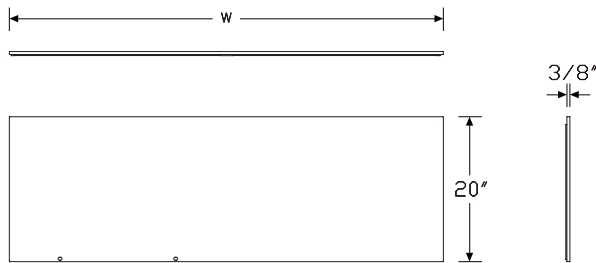

Specification Information

Step 1.

FF889.20 A

Step 2. Width

- 30** 30" wide A
- 36** 36" wide A
- 42** 42" wide A
- 48** 48" wide A
- 60** 60" wide A
- 66** 66" wide A
- 72** 72" wide A

Step 3. Top Material

- 03** 3/8" laminate top A
- 04** 3/8" veneer top A

Step 4. Configuration

For 30" wide (30), 36" wide (36), or 42" wide (42)

- FW** full width screen A

For 48" wide (48)

- AA** 30" screen left A
- AB** 30" screen right A
- FW** full width screen A

For 60" wide (60)

- AA** 30" screen left A
- AB** 30" screen right A
- AC** 36" screen left A
- AD** 36" screen right A
- FW** full width screen A

For 66" wide (66) or 72" wide (72)

- AC** 36" screen left A
- AD** 36" screen right A
- AE** 42" screen left A
- AF** 42" screen right A
- FW** full width screen A

Prices for Steps 1-4.

		AA	AB	AC	AE	AD	AF
FF889.20	48 03	\$377	377	—	—	—	—
	04	\$825	825	—	—	—	—
	60 03	\$465	465	465	—	465	—
	04	\$944	944	944	—	944	—

Credenza Top for Wood Credenza,
with Pari Screen, Storage
Attached *continued*

Canvas Office Landscape® Wood Case Credenzas

66 03	—	—	\$505	505	505	505
04	—	—	\$1026	1026	1026	1026
72 03	—	—	\$527	527	527	527
04	—	—	\$1057	1057	1057	1057

		FW
FF889.20 30 03		\$274
04		\$650
36 03		\$310
04		\$728
42 03		\$356
04		\$774
48 03		\$377
04		\$825
60 03		\$465
04		\$944
66 03		\$505
04		\$1026
72 03		\$527
04		\$1057

Step 5. Top Finish

For 3/8" laminate top (03)

8Q	folkstone grey <input type="checkbox"/>	+\$0
91	white <input type="checkbox"/>	+\$0
98	studio white <input type="checkbox"/>	+\$0
CL	cool grey neutral <input type="checkbox"/>	+\$0
LU	soft white <input type="checkbox"/>	+\$0
WL	sandstone <input type="checkbox"/>	+\$0
WN	warm grey neutral <input type="checkbox"/>	+\$0

For 3/8" laminate top (03)

76	light brown walnut <input type="checkbox"/>	+\$0
HM	natural maple <input type="checkbox"/>	+\$0
HP	light anigre <input type="checkbox"/>	+\$0
HX	aged cherry <input type="checkbox"/>	+\$0
HY	walnut on cherry <input type="checkbox"/>	+\$0
LBA	clear on ash <input type="checkbox"/>	+\$0
LBR	phantom ecru <input type="checkbox"/>	+\$0
LBS	phantom cocoa <input type="checkbox"/>	+\$0
LBU	medium matte walnut <input type="checkbox"/>	+\$0
LBV	warm grey teak <input type="checkbox"/>	+\$0
LBB	oak on ash <input type="checkbox"/>	+\$0
LBC	walnut on ash <input type="checkbox"/>	+\$0
LBD	dark brown walnut <input type="checkbox"/>	+\$0
LBE	medium red walnut <input type="checkbox"/>	+\$0

For 3/8" laminate top (03)

LBM	crisp linen <input type="checkbox"/>	+\$0
LBN	classic linen <input type="checkbox"/>	+\$0
LBP	casual linen <input type="checkbox"/>	+\$0

For 3/8" laminate top (03)

LBK	pewter mesh <input type="checkbox"/>	+\$0
LBL	steel mesh <input type="checkbox"/>	+\$0

For 3/8" laminate top (03)

LBF	neutral twill <input type="checkbox"/>	+\$0
LBG	sarum twill <input type="checkbox"/>	+\$0
LBH	earthen twill <input type="checkbox"/>	+\$0
LBJ	graphite twill <input type="checkbox"/>	+\$0
LBQ	white twill <input type="checkbox"/>	+\$0

For 3/8" veneer top (04)

2U	light brown walnut <input type="checkbox"/>	+\$0
40	dark brown walnut <input type="checkbox"/>	+\$0
ED	aged cherry <input type="checkbox"/>	+\$0
EK	medium red walnut <input type="checkbox"/>	+\$0
EW	medium matte walnut <input type="checkbox"/>	+\$0
ET	clear on ash <input type="checkbox"/>	+\$0
EU	oak on ash <input type="checkbox"/>	+\$0
EV	walnut on ash <input type="checkbox"/>	+\$0
UL	natural maple <input type="checkbox"/>	+\$0
UX	walnut on cherry <input type="checkbox"/>	+\$0

Credenza Top for Wood Credenza FF890.

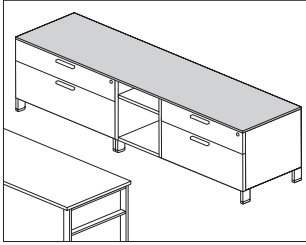

Product Information

Description

This 3/8"-high laminate or veneer credenza top can be used to cover a single credenza or 2 credenzas ganged side by side. Attachment hardware included.

Notes

For additional product options, see Vary Easy Program in Appendices.

Dimensions

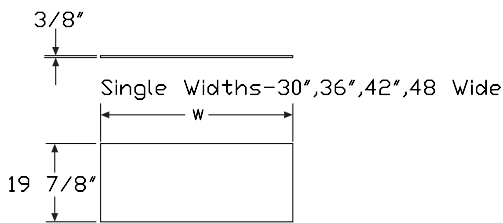

Combination Widths

60" Wide



30"/30"

66" Wide



36"/30"

72" Wide



36"/36"



42"/30"

Specification Information

Step 1.

FF890.20 [A]

Step 2. Width

- 30** 30" wide [A]
- 36** 36" wide [A]
- 42** 42" wide [A]
- 48** 48" wide [A]
- 60** 60" wide [A]
- 66** 66" wide [A]
- 72** 72" wide [A]

Step 3. Top Material

- 03** 3/8" laminate top [A]
- 04** 3/8" veneer top [A]

Prices for Steps 1-3.

		03	04
FF890.20	30	\$268	641
	36	\$304	721
	42	\$348	764
	48	\$370	816
	60	\$454	935
	66	\$497	1014
	72	\$519	1052

Step 4. Top Finish

Solid-Color Laminate

For 3/8" laminate top (03)

8Q	folkstone grey [A]	+\$0
91	white [A]	+\$0
98	studio white	+\$0
CL	cool grey neutral [A]	+\$0
LU	soft white [A]	+\$0
WL	sandstone [A]	+\$0
WN	warm grey neutral [A]	+\$0

Linen Laminate

For 3/8" laminate top (03)

LBM	crisp linen	+\$0
LBN	classic linen	+\$0
LBP	casual linen	+\$0

Credenza Top for Wood Credenza

continued

Canvas Office Landscape® Wood Case Credenzas

Mesh Laminate

For 3/8" laminate top (03)

LBK	pewter mesh	+\$0
LBL	steel mesh	+\$0

Twill Laminate

For 3/8" laminate top (03)

LBF	neutral twill	+\$0
LBG	sarum twill	+\$0
LBH	earthen twill	+\$0
LBJ	graphite twill	+\$0
LBQ	white twill	+\$0

Wood-Grain Laminate

For 3/8" laminate top (03)

HM	natural maple <input type="checkbox"/> A	+\$0
HP	light anigre <input type="checkbox"/> A	+\$0
LBA	clear on ash	+\$0
LBR	phantom ecru	+\$0
LBS	phantom cocoa	+\$0
LBU	medium matte walnut	+\$0
LBV	warm grey teak	+\$0
LBB	oak on ash	+\$0
LBC	walnut on ash	+\$0
LBD	dark brown walnut	+\$0
LBE	medium red walnut	+\$0
76	light brown walnut <input type="checkbox"/> A	+\$0
HX	aged cherry <input type="checkbox"/> A	+\$0
HY	walnut on cherry <input type="checkbox"/> A	+\$0

Wood Veneer

For 3/8" veneer top (04)

2U	light brown walnut <input type="checkbox"/> A	+\$0
40	dark brown walnut <input type="checkbox"/> A	+\$0
ED	aged cherry <input type="checkbox"/> A	+\$0
EK	medium red walnut <input type="checkbox"/> A	+\$0
EW	medium matte walnut <input type="checkbox"/> A	+\$0
ET	clear on ash <input type="checkbox"/> A	+\$0
EU	oak on ash <input type="checkbox"/> A	+\$0
EV	walnut on ash <input type="checkbox"/> A	+\$0
UL	natural maple <input type="checkbox"/> A	+\$0
UX	walnut on cherry <input type="checkbox"/> A	+\$0

Pari Screen, Storage Attached

FV360.

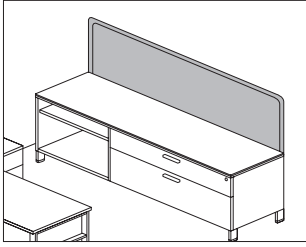

Product Information

Description

This tackable fabric screen attaches to a Canvas low credenza using the thin top and provides boundary with a tackable surface. Attachment hardware included.

Notes

Order credenza thin top separately:

- Credenza top for wood credenza (FF889.)
- Credenza top for metal credenza (FM889.)

Predrilled holes near back edge of credenza thin top allow for bayonets to extend up to support the screen.

Works with standard and powered Canvas credenzas.

Screen accepts Customer's Own Material (COM). Yardage is estimated for nondirectional 54"-wide fabrics.

For vertical fabric direction (T):

Height—Yardage

24—0.95

30—1.14

36—1.32

For horizontal fabric direction (R), for 42" high:

Width—Yardage

24—0.95

30—1.14

36—1.32

42—1.51

48—1.71

60—2.07

66—2.27

72—2.46

For horizontal fabric direction (R), for 46" high and 53" high:

Width—Yardage

24—1.90

30—2.27

36—2.66

42—3.02

48—3.41

60—4.17

66—4.54

72—4.92

For information on multiple quantities or directional fabrics, contact COM Department. See Order Information in Appendices.

Dimensions

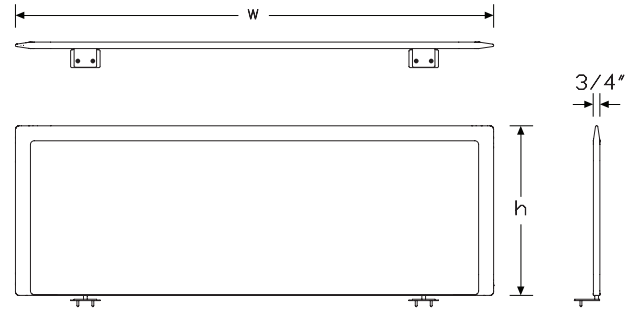

Pari Screen, Storage Attached

continued

Canvas Office Landscape® Wood Case Credenzas

Specification Information

Step 1.

FV360. A

Step 2. Attachment

CS Canvas credenza attached, single A

CB Canvas credenza attached, back to back A

Step 3. Height

42 42" high A

46 46" high A

53 53" high A

Step 4. Width

30 30" wide A

36 36" wide A

42 42" wide A

48 48" wide A

60 60" wide A

66 66" wide A

72 72" wide A

Step 5. Surface Material

For 30" wide (30), 36" wide (36), 42" wide (42), or 48" wide (48)

R tackable fabric, horizontal A

T tackable fabric A

For 60" wide (60), 66" wide (66), or 72" wide (72)

R tackable fabric, horizontal A

Prices for Steps 1-5.

	30R	30T	36R	36T	42R	42T
FV360. CS 42	\$735	735	765	765	810	810
46	\$765	765	855	855	900	900
53	\$900	900	945	945	1095	1095
CB 42	\$735	735	765	765	810	810
46	\$765	765	855	855	900	900
53	\$900	900	945	945	1095	1095
	48R	48T	60R	66R	72R	
FV360. CS 42	\$945	945	1080	1100	1125	
46	\$990	990	1125	1190	1215	
53	\$1170	1170	1305	1370	1395	
CB 42	\$945	945	1080	1100	1125	
46	\$990	990	1125	1190	1215	
53	\$1170	1170	1305	1370	1395	

Step 6. Fabric

For 30" wide (30), 36" wide (36), or 42" wide (42)

Price Category 1 +\$0

Price Category 2 +\$38

Price Category 3 +\$90

Price Category 4 +\$156

Price Category E +\$325

For 48" wide (48) or 60" wide (60)

Price Category 1 +\$0

Price Category 2 +\$31

Price Category 3 +\$74

Price Category 4 +\$127

Price Category E +\$325

For 66" wide (66) or 72" wide (72)

Price Category E +\$325

Price Category 1 +\$0

Price Category 2 +\$38

Price Category 3 +\$90

Price Category 4 +\$156

Credenza Cushion Top

FF891.

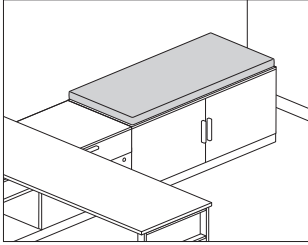

Product Information

Description

This cushion attaches to the top of a metal or wood credenza to provide temporary guest seating. Attachment hardware included.

Notes

Cushion accepts Customer's Own Material (COM). Yardage is estimated for nondirectional, 54"-wide fabrics. Order 1 yard of fabric per cushion. For odd number of cushions, round up to next full yard. For information on multiple quantities or directional fabrics, contact COM Department. See Order Information in Appendices.

Dimensions

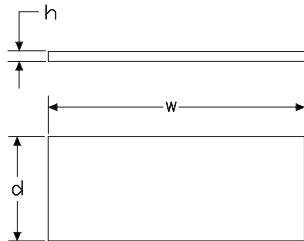

Specification Information

Step 1.

FF891. A

Step 2. Height

01 1" high A

02 2" high A

Step 3. Depth

20 20" deep A

Step 4. Width

24 24" wide A

30 30" wide A

36 36" wide A

42 42" wide A

48 48" wide A

Prices for Steps 1-4.

	24	30	36	42	48
FF891. 01 20	\$244	262	281	292	306
02 20	\$293	318	345	366	385

Step 5. Fabric

See application chart and textiles list for fabric usage and numbers.

First 2 digits of number indicate fabric line; remaining digit(s) indicate fabric color.

Price Category 1	+\$0
Price Category 2	+\$102
Price Category 3	+\$123
Price Category 4	+\$151
Price Category 5	+\$169
Price Category 7	+\$206
Price Category 8	+\$146
Price Category 9	+\$1425
Price Category (Geiger) 10	+\$1050
Price Category B	+\$71
Price Category C	+\$98
Price Category D	+\$82
Price Category E	+\$150
Price Category F	+\$193
Price Category G	+\$251
Price Category H	+\$305
Price Category I	+\$359
Price Category J	+\$413
Price Category K	+\$310

Wood Credenza Shelf

FF892.

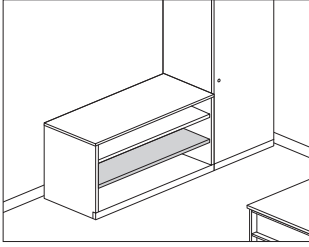

Product Information

Description

This laminate or veneer shelf fits into a wood credenza to provide additional shelf storage. Shelf attachment pins included.

Dimensions

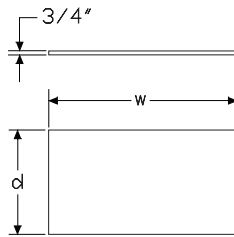

Canvas Office Landscape® Wood Case Credenzas

Specification Information

Step 1.

FF892. A

Step 2. Credenza Type

- A** for credenza, open or credenza, with doors A
- B** for credenza, open with drawers A
- C** for credenza, doors with drawers A

Step 3. Width

For credenza, open or credenza, with doors (A)

- 21** 21" wide A
- 24** 24" wide A
- 3A** 30" wide, for 30"-wide credenza A
- 3B** 30" wide, for 60"-wide credenza A
- 36** 36" wide A

For credenza, open with drawers (B)

- 18** 18" wide A
- 24** 24" wide A
- 30** 30" wide A
- 36** 36" wide A

For credenza, doors with drawers (C)

- 18** 18" wide A
- 30** 30" wide A
- 36** 36" wide A

Step 4. Depth

- 20** 20" deep A

Step 5. Surface Material

- L** laminate A
- W** veneer A

Prices for Steps 1-5.

		20L	20W
FF892. A	21	\$177	266
	24	\$188	298
	24	\$188	298
	3A	\$222	365
	3B	\$222	365
	36	\$255	431

Wood Credenza Shelf *continued*

B 18	\$167	233
24	\$188	298
24	\$188	298
30	\$222	365
36	\$255	431
C 18	\$167	233
30	\$222	365
36	\$255	431

Step 6. Surface Finish

Solid-Color Laminate

For laminate (L)

8Q	folkstone grey <input type="checkbox"/>	+\$0
91	white <input type="checkbox"/>	+\$0
98	studio white	+\$0
CL	cool grey neutral <input type="checkbox"/>	+\$0
LU	soft white <input type="checkbox"/>	+\$0
WL	sandstone <input type="checkbox"/>	+\$0
WN	warm grey neutral <input type="checkbox"/>	+\$0

Linen Laminate

For laminate (L)

LBM	crisp linen	+\$0
LBN	classic linen	+\$0
LBP	casual linen	+\$0

Mesh Laminate

For laminate (L)

LBK	pewter mesh	+\$0
LBL	steel mesh	+\$0

Twill Laminate

For laminate (L)

LBF	neutral twill	+\$0
LBG	sarum twill	+\$0
LBH	earthen twill	+\$0
LBJ	graphite twill	+\$0
LBQ	white twill	+\$0

Wood-Grain Laminate

For laminate (L)

HM	natural maple <input type="checkbox"/>	+\$0
HP	light anigre <input type="checkbox"/>	+\$0
LBA	clear on ash	+\$0
LBR	phantom ecru	+\$0
LBS	phantom cocoa	+\$0
LBU	medium matte walnut	+\$0
LBV	warm grey teak	+\$0
LBB	oak on ash	+\$0
LBC	walnut on ash	+\$0
LBD	dark brown walnut	+\$0
LBE	medium red walnut	+\$0
76	light brown walnut <input type="checkbox"/>	+\$0
HX	aged cherry <input type="checkbox"/>	+\$0
HY	walnut on cherry <input type="checkbox"/>	+\$0

For veneer (W)

2U	light brown walnut <input type="checkbox"/>	+\$0
40	dark brown walnut <input type="checkbox"/>	+\$0
ED	aged cherry <input type="checkbox"/>	+\$0
EK	medium red walnut <input type="checkbox"/>	+\$0
EW	medium matte walnut <input type="checkbox"/>	+\$0
ET	clear on ash <input type="checkbox"/>	+\$0
EU	oak on ash <input type="checkbox"/>	+\$0
EV	walnut on ash <input type="checkbox"/>	+\$0
UL	natural maple <input type="checkbox"/>	+\$0
UX	walnut on cherry <input type="checkbox"/>	+\$0

Powered Storage Ganging Bracket PS900 Kit

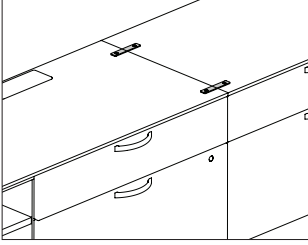

Product Information

Description

This kit has 2 brackets that attach to the case under the tops of 2 adjacent surfaces, ganging them together to provide stability and allowing electrical components to be routed from one case to another. Finish is black.

Notes

Power that is being routed from one case to another requires the cases be ganged together.
Single cases require counterweight to be specified.

Specification Information

Step 1.

PS900 A \$31

Powered Wood Low Credenza,
with Drawers

FFD72A
FFD72K

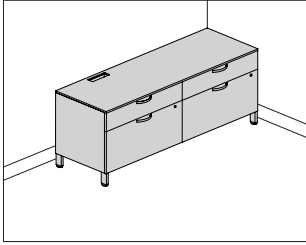

Product Information

Description

This powered credenza provides enclosed filing and storage and can be used freestanding, to support 1 end of a surface, or attached to a Canvas wall-based frame to support a frame run. It has a $\frac{3}{8}$ "-high laminate or veneer top and the choice of a laminate case and front, veneer case and front, or laminate case with veneer front. The credenza is available with 4"-high architectural feet with 1" leveling glides and has a positive interlock system that permits only 1 drawer to open at a time. Drawers have full-extension ball-bearing slides. The file drawer(s) accommodate side-to-side and front-to-back filing of letter-, legal, and A4-size hanging files. Connect™ power distributors with modular ends are ordered and installed separately.

Actual powered credenza widths are $59\frac{3}{4}$ " , or $71\frac{3}{4}$ " ; actual depth is $19\frac{7}{8}$ " .

Notes

For additional product options, see Vary Easy Program in Appendices. Arc pull option (A.) conforms to guidelines of Americans with Disabilities Act (ADA).

Grain direction is vertical on veneer and wood-grain laminate fronts.

60"-and 72"-wide credenzas have 2 box drawers and 2 file drawers.

Credenza with 4"-high foot option (4) and $\frac{3}{8}$ " thin top can be used to support a Canvas wall-based frame. Order support bracket, low credenza-to-frame (FT292.) separately.

When using credenza to support 1 end of a surface, order 1 of the following products separately:

- Surface support, low credenza, adjustable height (FT299.)
- Surface support, low credenza, fixed height (FT298.)

To cover adjacent credenzas with a single top, specify credenzas with no top option (NT) and order credenza top (FM890.) separately.

To provide temporary guest seating on a credenza, order cushion top (FF891.) separately.

Order the following products separately:

- Connect - S310 electrical unit with connect modular connection (Y1329.)
- Connect - power entry, 4-circuit (Y1351.)
- Connect - junction block to junction block jumper, 4-circuit (Y1353.)
- Connect - H-block connector, 4-circuit (Y1354.H)

Powered credenzas must be ganged together.

For keyed-alike locks, see Keyed-Alike Information in Appendices.

Dimensions

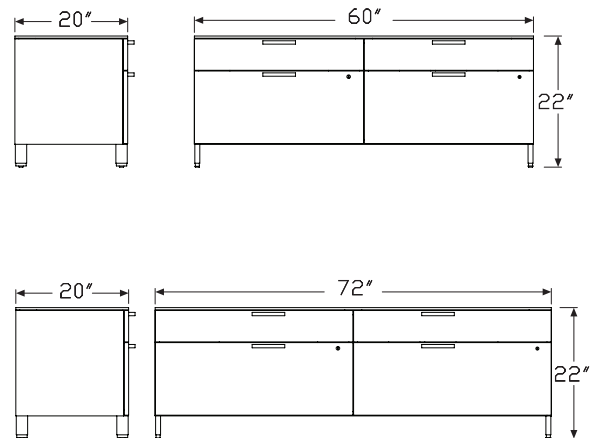

Powered Wood Low Credenza,
with Drawers *continued*

Specification Information

Step 1.

FFD72 A

Step 2. Pull Type

- A.** arc pull A
- K.** bar pull A

Step 3. Width

- 60** 60" wide A
- 72** 72" wide A

Step 4. Depth

- 20** 20" deep A

Step 5. Base/Foot Height

- 4** 4"-high foot A

Step 6. Configuration

- BF** box/file A

Step 7. Case/Front Material

- L** laminate case/front A
- C** laminate case/veneer front A

Step 8. Top

- NT** no top A
- 03** 3/8" laminate top A
- 04** 3/8" veneer top A

Step 9. Power Access Location

- L** left center access A
- R** right center access A

Prices for Steps 1-9.

	4BFLNLT	4BFLNTR	4BFL03L	4BFL03R	4BFL04L	4BFL04R
FFD72A. 60 20	\$4207	4207	4372	4372	4648	4648
72 20	\$4796	4796	4905	4905	5018	5124

	4BFCNTL	4BFCNTR	4BFC03L	4BFC03R	4BFC04L	4BFC04R
FFD72A. 60 20	\$5029	5029	5193	5193	5469	5469
72 20	\$5614	5614	5833	5833	6162	6162

	4BFLNLT	4BFLNTR	4BFL03L	4BFL03R	4BFL04L	4BFL04R
FFD72K. 60 20	\$4207	4207	4372	4372	4648	4648
72 20	\$4796	4796	4905	4905	5018	5124

	4BFCNTL	4BFCNTR	4BFC03L	4BFC03R	4BFC04L	4BFC04R
FFD72K. 60 20	\$5029	5029	5193	5193	5469	5469
72 20	\$5614	5614	5833	5833	6162	6162

Step 10. Case Finish

For 60" wide (60) with laminate case/front (L), or laminate case/veneer front (C)

- LBM** crisp linen A +\$0
- LBN** classic linen A +\$0
- LBP** casual linen A +\$0

For 60" wide (60) with laminate case/front (L), or laminate case/veneer front (C)

- LBK** pewter mesh A +\$0
- LBL** steel mesh A +\$0

Solid-Color Laminate

For 60" wide (60) with laminate case/front (L), or laminate case/veneer front (C)

- 8Q** folkstone grey A +\$0
- 91** white A +\$0
- 98** studio white A +\$0
- CL** cool grey neutral A +\$0
- LU** soft white A +\$0
- WL** sandstone A +\$0
- WN** warm grey neutral A +\$0

For 60" wide (60) with laminate case/front (L), or laminate case/veneer front (C)

- LBF** neutral twill A +\$0
- LBG** sarum twill A +\$0
- LBH** earthen twill A +\$0
- LBJ** graphite twill A +\$0
- LBQ** white twill A +\$0

Powered Wood Low Credenza,
with Drawers *continued*

Wood-Grain Laminate

For 60" wide (60) with laminate case/front (L), or laminate case/veneer front (C)

LBC	walnut on ash <input type="checkbox"/>	+\$0
LBE	medium red walnut <input type="checkbox"/>	+\$0
HM	natural maple <input type="checkbox"/>	+\$0
HP	light anigre <input type="checkbox"/>	+\$0
LBA	clear on ash <input type="checkbox"/>	+\$0
LBR	phantom ecru <input type="checkbox"/>	+\$0
LBS	phantom cocoa <input type="checkbox"/>	+\$0
LBU	medium matte walnut <input type="checkbox"/>	+\$0
LBV	warm grey teak <input type="checkbox"/>	+\$0
LBB	oak on ash <input type="checkbox"/>	+\$0
LBD	dark brown walnut <input type="checkbox"/>	+\$0
76	light brown walnut <input type="checkbox"/>	+\$0
HX	aged cherry <input type="checkbox"/>	+\$0
HY	walnut on cherry <input type="checkbox"/>	+\$0

For 72" wide (72) with laminate case/front (L), or laminate case/veneer front (C)

LBM	crisp linen <input type="checkbox"/>	+\$0
LBN	classic linen <input type="checkbox"/>	+\$0
LBP	casual linen <input type="checkbox"/>	+\$0

For 72" wide (72) with laminate case/front (L), or laminate case/veneer front (C)

LBK	pewter mesh <input type="checkbox"/>	+\$0
LBL	steel mesh <input type="checkbox"/>	+\$0

Solid-Color Laminate

For 72" wide (72) with laminate case/front (L), or laminate case/veneer front (C)

8Q	folkstone grey <input type="checkbox"/>	+\$0
91	white <input type="checkbox"/>	+\$0
98	studio white <input type="checkbox"/>	+\$0
CL	cool grey neutral <input type="checkbox"/>	+\$0
LU	soft white <input type="checkbox"/>	+\$0
WL	sandstone <input type="checkbox"/>	+\$0
WN	warm grey neutral <input type="checkbox"/>	+\$0

Step 11. Front Finish

For laminate case/front (L)

LBM	crisp linen <input type="checkbox"/>	+\$0
LBN	classic linen <input type="checkbox"/>	+\$0
LBP	casual linen <input type="checkbox"/>	+\$0

For laminate case/front (L)

LBK	pewter mesh <input type="checkbox"/>	+\$0
LBL	steel mesh <input type="checkbox"/>	+\$0

Solid-Color Laminate

For laminate case/front (L)

8Q	folkstone grey <input type="checkbox"/>	+\$0
91	white <input type="checkbox"/>	+\$0
98	studio white <input type="checkbox"/>	+\$0
CL	cool grey neutral <input type="checkbox"/>	+\$0
LU	soft white <input type="checkbox"/>	+\$0
WL	sandstone <input type="checkbox"/>	+\$0
WN	warm grey neutral <input type="checkbox"/>	+\$0

For laminate case/front (L)

LBF	neutral twill <input type="checkbox"/>	+\$0
LBG	sarum twill <input type="checkbox"/>	+\$0
LBH	earthen twill <input type="checkbox"/>	+\$0
LBJ	graphite twill <input type="checkbox"/>	+\$0
LBQ	white twill <input type="checkbox"/>	+\$0

Wood-Grain Laminate

For laminate case/front (L)

LBC	walnut on ash <input type="checkbox"/>	+\$0
LBE	medium red walnut <input type="checkbox"/>	+\$0
HM	natural maple <input type="checkbox"/>	+\$0
HP	light anigre <input type="checkbox"/>	+\$0
LBA	clear on ash <input type="checkbox"/>	+\$0
LBR	phantom ecru <input type="checkbox"/>	+\$0
LBS	phantom cocoa <input type="checkbox"/>	+\$0
LBU	medium matte walnut <input type="checkbox"/>	+\$0
LBV	warm grey teak <input type="checkbox"/>	+\$0
LBB	oak on ash <input type="checkbox"/>	+\$0
LBD	dark brown walnut <input type="checkbox"/>	+\$0
76	light brown walnut <input type="checkbox"/>	+\$0
HX	aged cherry <input type="checkbox"/>	+\$0
HY	walnut on cherry <input type="checkbox"/>	+\$0

Powered Wood Low Credenza, with Drawers *continued*

Wood Veneer		
<i>For laminate case/veneer front (C)</i>		
2U	light brown walnut <input type="checkbox"/>	+\$0
40	dark brown walnut <input type="checkbox"/>	+\$0
ED	aged cherry <input type="checkbox"/>	+\$0
EK	medium red walnut <input type="checkbox"/>	+\$0
EW	medium matte walnut <input type="checkbox"/>	+\$0
ET	clear on ash <input type="checkbox"/>	+\$0
EV	walnut on ash <input type="checkbox"/>	+\$0
UL	natural maple <input type="checkbox"/>	+\$0
UX	walnut on cherry <input type="checkbox"/>	+\$0

Step 12. Top Finish

<i>For 3/8" laminate top (03)</i>		
LBM	crisp linen <input type="checkbox"/>	+\$0
LBN	classic linen <input type="checkbox"/>	+\$0
LBP	casual linen <input type="checkbox"/>	+\$0

<i>For 3/8" laminate top (03)</i>		
LBK	pewter mesh <input type="checkbox"/>	+\$0
LBL	steel mesh <input type="checkbox"/>	+\$0

Solid-Color Laminate		
<i>For 3/8" laminate top (03)</i>		
8Q	folkstone grey <input type="checkbox"/>	+\$0
91	white <input type="checkbox"/>	+\$0
98	studio white <input type="checkbox"/>	+\$0
CL	cool grey neutral <input type="checkbox"/>	+\$0
LU	soft white <input type="checkbox"/>	+\$0
WL	sandstone <input type="checkbox"/>	+\$0
WN	warm grey neutral <input type="checkbox"/>	+\$0

<i>For 3/8" laminate top (03)</i>		
LBF	neutral twill <input type="checkbox"/>	+\$0
LBG	sarum twill <input type="checkbox"/>	+\$0
LBH	earthen twill <input type="checkbox"/>	+\$0
LBJ	graphite twill <input type="checkbox"/>	+\$0
LBQ	white twill <input type="checkbox"/>	+\$0

Wood-Grain Laminate		
<i>For 3/8" laminate top (03)</i>		
LBC	walnut on ash <input type="checkbox"/>	+\$0
LBE	medium red walnut <input type="checkbox"/>	+\$0
HM	natural maple <input type="checkbox"/>	+\$0
HP	light anigre <input type="checkbox"/>	+\$0
LBA	clear on ash <input type="checkbox"/>	+\$0
LBR	phantom ecru <input type="checkbox"/>	+\$0
LBS	phantom cocoa <input type="checkbox"/>	+\$0
LBU	medium matte walnut <input type="checkbox"/>	+\$0
LBV	warm grey teak <input type="checkbox"/>	+\$0
LBB	oak on ash <input type="checkbox"/>	+\$0
LBD	dark brown walnut <input type="checkbox"/>	+\$0
76	light brown walnut <input type="checkbox"/>	+\$0
HX	aged cherry <input type="checkbox"/>	+\$0
HY	walnut on cherry <input type="checkbox"/>	+\$0

Wood Veneer		
<i>For 3/8" veneer top (04)</i>		
2U	light brown walnut <input type="checkbox"/>	+\$0
40	dark brown walnut <input type="checkbox"/>	+\$0
ED	aged cherry <input type="checkbox"/>	+\$0
EK	medium red walnut <input type="checkbox"/>	+\$0
EW	medium matte walnut <input type="checkbox"/>	+\$0
ET	clear on ash <input type="checkbox"/>	+\$0
EV	walnut on ash <input type="checkbox"/>	+\$0
UL	natural maple <input type="checkbox"/>	+\$0
UX	walnut on cherry <input type="checkbox"/>	+\$0

Step 13. Foot Finish		
8Q	folkstone grey <input type="checkbox"/>	+\$0
98	studio white <input type="checkbox"/>	+\$0
WL	sandstone <input type="checkbox"/>	+\$0

Bright Sand Texture Paint		
91	white <input type="checkbox"/>	+\$0
CL	cool grey neutral <input type="checkbox"/>	+\$0
G1	graphite <input type="checkbox"/>	+\$0
WN	warm grey neutral <input type="checkbox"/>	+\$0

Metallic Paint		
CN	metallic champagne <input type="checkbox"/>	+\$0
EH	metallic bronze <input type="checkbox"/>	+\$0
MS	metallic silver <input type="checkbox"/>	+\$0

Powered Wood Low Credenza,
with Drawers *continued*

Step 14. Pull Finish

For arc pull (A.)

NH	brushed nickel <input type="checkbox"/>	+\$0
NK	black nickel <input type="checkbox"/>	+\$0

For bar pull (K.)

8Q	folkstone grey	+\$0
91	white	+\$0
98	studio white <input type="checkbox"/>	+\$0
G1	graphite <input type="checkbox"/>	+\$0
WL	sandstone <input type="checkbox"/>	+\$0
CN	metallic champagne <input type="checkbox"/>	+\$0
MS	metallic silver <input type="checkbox"/>	+\$0
79	green apple <input type="checkbox"/>	+\$15
MY3	yellow oxide <input type="checkbox"/>	+\$15
RO	red <input type="checkbox"/>	+\$15
TRQ	turquoise <input type="checkbox"/>	+\$15

Step 15. Counterweight

NO	no counterweight <input type="checkbox"/>	+\$0
CB	counterweight <input type="checkbox"/>	+\$70

Step 16. Lock Option

KA	keyed alike <input type="checkbox"/>	-\$10
KC	keyed differently, chrome <input type="checkbox"/>	+\$0
KD	keyed differently, black <input type="checkbox"/>	+\$0

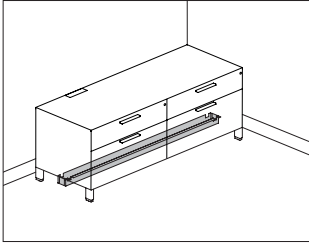

Product Information

Description

This cable cover attaches to a metal or wood Canvas Office Landscape® powered low credenza, and is available in 3 configurations: center, full-span, and side placement. It is used in conjunction with Connect™ components to comply with UL1286 listing. Finish is black.

Notes

Order the following products separately:

- Canvas powered metal low credenza (FMP72, FMP73, FMP74)
- Canvas powered wood low credenza (FFD72, FFD73, FFD74)
- Connect - S310 electrical unit with connect modular connection (Y1329.)
- Connect - power entry, 4-circuit (Y1351.)
- Connect - junction block to junction block jumper, 4-circuit (Y1353.)
- Connect - H-block connector, 4-circuit (Y1354.H)
- Powered storage distributor cover (FPS911.)

Canvas Office Landscape® Wood Case Credenzas

Dimensions

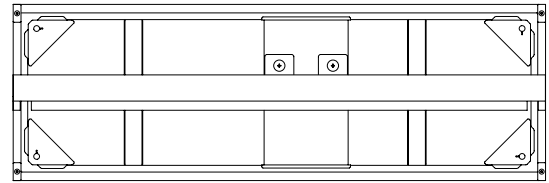

Full

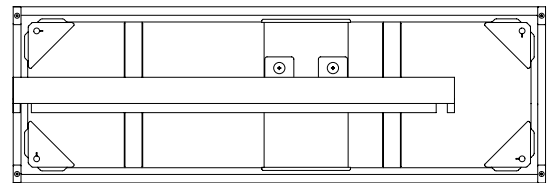

Side

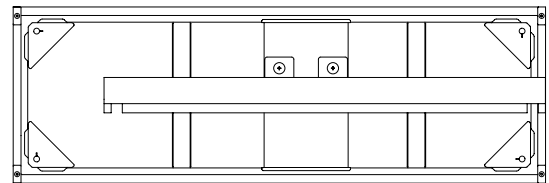

Side

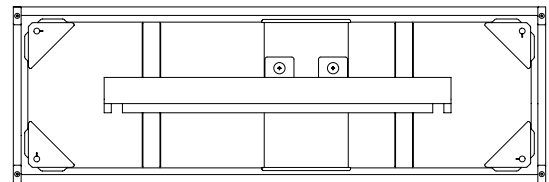

Center

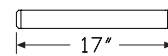
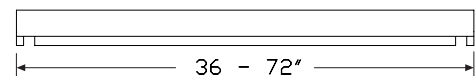

Cross bars for use with metal credenza only

Powered Storage Cable Cover

continued

Specification Information

Step 1.

FPS910. A

Step 2. Material

F for use with wood powered low credenza A

M for use with metal powered low credenza A

Step 3. Case Width

48 48" wide A

60 60" wide A

66 66" wide A

72 72" wide A

Step 4. Configuration

C center A

F full A

S side A

Prices for Steps 1-4.

				C	F	S
FPS910. F	48			\$97	97	97
	60			\$120	120	120
	66			\$120	120	120
	72			\$120	120	120
M	48			\$204	204	204
	60			\$227	227	227
	66			\$227	227	227
	72			\$227	227	227

Powered Wood Low Credenza,
Open with Drawers

FFD73A
FFD73K

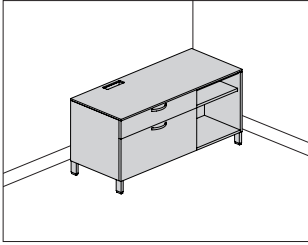

Product Information

Description

This powered credenza provides drawer storage on 1 side with open storage on the other side and can be used freestanding, to support 1 end of a surface, or attached to a Canvas wall-based frame to support a frame run. It has a $\frac{3}{8}$ "-high laminate or veneer top and the choice of a laminate case and front, veneer case and front, or laminate case with veneer front. The credenza is available with 4"-high architectural feet with 1" leveling glides and has a positive interlock system that permits only 1 drawer to open at a time. Drawers have full-extension ball-bearing slides. The file drawer(s) accommodate side-to-side and front-to-back filing of letter-, legal, and A4-size hanging files. Connect™ power distributors with modular ends are ordered and installed separately. Actual powered credenza widths are $47\frac{3}{4}$ ", $59\frac{3}{4}$ ", $65\frac{3}{4}$ ", or $71\frac{3}{4}$ "; actual depth is $19\frac{7}{8}$ ".

Notes

For additional product options, see Vary Easy® Program in Appendices. Arc pull option (A.) conforms to guidelines of Americans with Disabilities Act (ADA).

Grain direction is vertical on veneer and wood-grain laminate fronts. Open side of credenza includes 1 adjustable shelf that adjusts in $\frac{1}{4}$ " increments.

Credenza with 4"-high foot option (4) and $\frac{3}{8}$ " thin top can be used to support a Canvas wall-based frame. Order support bracket, low credenza-to-frame (FT292.) separately.

When using credenza to support 1 end of a surface, order 1 of the following products separately:

- Surface support, low credenza, adjustable height (FT299.)
- Surface support, low credenza, fixed height (FT298.)

To cover adjacent credenzas with a single top, specify credenzas with no top option (NT) and order credenza top (FM890.) separately.

Order optional wood credenza shelf (FF892.) separately.

To provide temporary guest seating on a credenza, order cushion top (FF891.) separately.

Order the following products separately:

- Connect - S310 electrical unit with connect modular connection (Y1329.)
- Connect - power entry, 4-circuit (Y1351.)
- Connect - junction block to junction block jumper, 4-circuit (Y1353.)
- Connect - H-block connector, 4-circuit (Y1354.H)

Powered credenzas must be ganged together.

For keyed-alike locks, see Keyed-Alike Information in Appendices.

Dimensions

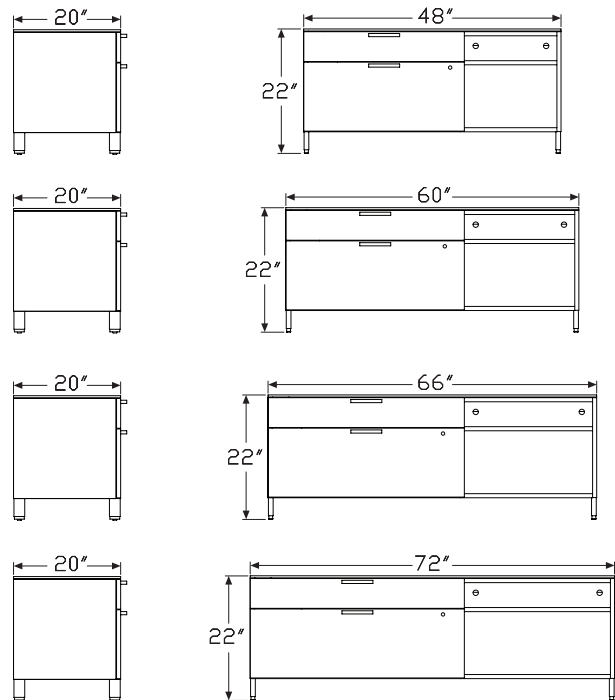

Powered Wood Low Credenza, Open with Drawers *continued*

Specification Information

Step 1.

FFD73

Step 2. Pull Type

A. arc pull

K. bar pull

Step 3. Width

48 48" wide

60 60" wide

66 66" wide

72 72" wide

Step 4. Depth

20 20" deep

Step 5. Base/Foot Height

4 4"-high foot

Step 6. Configuration

For 48" wide (48)

AA 30" box/file left, open right

AB open left, 30" box/file right

For 60" wide (60)

AA 30" box/file left, open right

AB open left, 30" box/file right

AC 36" box/file left, open right

AD open left, 36" box/file right

For 66" wide (66)

AC 36" box/file left, open right

AD open left, 36" box/file right

AE 42" box/file left, open right

AF open left, 42" box/file right

For 72" wide (72)

AC 36" box/file left, open right

AD open left, 36" box/file right

AE 42" box/file left, open right

AF open left, 42" box/file right

Step 7. Case/Front Material

L laminate case/front

C laminate case/veneer front

Step 8. Top

NT no top

03 3/8" laminate top

04 3/8" veneer top

Step 9. Top Power Access Location

For open left, 30" box/file right (AB), open left, 36" box/file right (AD), or open left, 42" box/file right (AF)

L left center access

For 30" box/file left, open right (AA), 36" box/file left, open right (AC), or 42" box/file left, open right (AE)

R right center access

Step 10. Inside Power Access Location

N no access

A power access inside of credenza

Prices for Steps 1-10.

	4AALNTRN	4AALNTRA	4AAL03RN	4AAL03RA	4AAL04RN	4AAL04RA
FFD73A. 48 20	\$2994	3021	3131	3157	3378	3405
60 20	\$3257	3283	3423	3449	3696	3723

	4AACNTRN	4AACNTRA	4AAC03RN	4AAC03RA	4AAC04RN	4AAC04RA
FFD73A. 48 20	\$3410	3437	3547	3573	3794	3820
60 20	\$3718	3744	3882	3908	4157	4184

	4ABLNTLN	4ABLNTLA	4ABL03LN	4ABL03LA	4ABL04LN	4ABL04LA
FFD73A. 48 20	\$2994	3021	3131	3157	3378	3405
60 20	\$3257	3283	3423	3449	3696	3723

	4ABCNTLN	4ABCNTLA	4ABC03LN	4ABC03LA	4ABC04LN	4ABC04LA
FFD73A. 48 20	\$3410	3437	3547	3573	3794	3820
60 20	\$3718	3744	3882	3908	4157	4184

	4ACLNTRN	4ACLNTRA	4ACL03RN	4ACL03RA	4ACL04RN	4ACL04RA
FFD73A. 60 20	\$3340	3366	3505	3531	3779	3805
66 20	\$3446	3473	3612	3638	3885	3911
72 20	\$3460	3487	3686	3712	4023	4050

	4ACCNTRN	4ACCNTRA	4ACC03RN	4ACC03RA	4ACC04RN	4ACC04RA
FFD73A. 60 20	\$3811	3839	3976	4003	4252	4277
66 20	\$3936	3961	4099	4126	4374	4401
72 20	\$3956	3983	4181	4207	4518	4546

Powered Wood Low Credenza,
Open with Drawers *continued*

Canvas Office Landscape® Wood Case Credenzas

		4AELNTRN	4AELNTRA	4AEL03RN	4AEL03RA	4AEL04RN	4AEL04RA
FFD73A.	66 20	\$3529	3555	3693	3720	3968	3994
	72 20	\$3579	3604	3803	3831	4142	4167
		4AECNTRN	4AECNTRA	4AEC03RN	4AEC03RA	4AEC04RN	4AEC04RA
FFD73A.	66 20	\$4029	4056	4194	4220	4469	4496
	72 20	\$4093	4119	4318	4345	4656	4682
		4ADLNTLN	4ADLNTLA	4ADL03LN	4ADL03LA	4ADL04LN	4ADL04LA
FFD73A.	60 20	\$3340	3366	3505	3531	3779	3805
	66 20	\$3446	3473	3612	3638	3885	3911
	72 20	\$3460	3487	3686	3712	4023	4050
		4ADCNTLN	4ADCNTLA	4ADC03LN	4ADC03LA	4ADC04LN	4ADC04LA
FFD73A.	60 20	\$3811	3839	3976	4003	4252	4277
	66 20	\$3936	3961	4099	4126	4374	4401
	72 20	\$3956	3983	4181	4207	4518	4546
		4AFLNTLN	4AFLNTLA	4AFL03LN	4AFL03LA	4AFL04LN	4AFL04LA
FFD73A.	66 20	\$3529	3555	3693	3720	3968	3994
	72 20	\$3579	3604	3803	3831	4142	4167
		4AFCNTLN	4AFCNTLA	4AFC03LN	4AFC03LA	4AFC04LN	4AFC04LA
FFD73A.	66 20	\$4029	4056	4194	4220	4469	4496
	72 20	\$4093	4119	4318	4345	4656	4682
		4AALNTRN	4AALNTRA	4AAL03RN	4AAL03RA	4AAL04RN	4AAL04RA
FFD73K.	48 20	\$2994	3021	3131	3157	3378	3405
	60 20	\$3257	3283	3423	3449	3696	3723
		4AACNTRN	4AACNTRA	4AAC03RN	4AAC03RA	4AAC04RN	4AAC04RA
FFD73K.	48 20	\$3410	3437	3547	3573	3794	3820
	60 20	\$3718	3744	3882	3908	4157	4184
		4ABLNTLN	4ABLNTLA	4ABL03LN	4ABL03LA	4ABL04LN	4ABL04LA
FFD73K.	48 20	\$2994	3021	3131	3157	3378	3405
	60 20	\$3257	3283	3423	3449	3696	3723
		4ABCNTLN	4ABCNTLA	4ABC03LN	4ABC03LA	4ABC04LN	4ABC04LA
FFD73K.	48 20	\$3410	3437	3547	3573	3794	3820
	60 20	\$3718	3744	3882	3908	4157	4184
		4ACLNTRN	4ACLNTRA	4ACL03RN	4ACL03RA	4ACL04RN	4ACL04RA
FFD73K.	60 20	\$3340	3366	3505	3531	3779	3805
	66 20	\$3446	3473	3612	3638	3885	3911
	72 20	\$3460	3487	3686	3712	4023	4050

		4ACCNTRN	4ACCNTRA	4ACC03RN	4ACC03RA	4ACC04RN	4ACC04RA
FFD73K.	60 20	\$3811	3839	3976	4003	4252	4277
	66 20	\$3936	3961	4099	4126	4374	4401
	72 20	\$3956	3983	4181	4207	4518	4546
		4AELNTRN	4AELNTRA	4AEL03RN	4AEL03RA	4AEL04RN	4AEL04RA
FFD73K.	66 20	\$3529	3555	3693	3720	3968	3994
	72 20	\$3579	3604	3803	3831	4142	4167
		4AECNTRN	4AECNTRA	4AEC03RN	4AEC03RA	4AEC04RN	4AEC04RA
FFD73K.	66 20	\$4029	4056	4194	4220	4469	4496
	72 20	\$4093	4119	4318	4345	4656	4682
		4ADLNTLN	4ADLNTLA	4ADL03LN	4ADL03LA	4ADL04LN	4ADL04LA
FFD73K.	60 20	\$3340	3366	3505	3531	3779	3805
	66 20	\$3446	3473	3612	3638	3885	3911
	72 20	\$3460	3487	3686	3712	4023	4050
		4ADCNTLN	4ADCNTLA	4ADC03LN	4ADC03LA	4ADC04LN	4ADC04LA
FFD73K.	60 20	\$3811	3839	3976	4003	4252	4277
	66 20	\$3936	3961	4099	4126	4374	4401
	72 20	\$3956	3983	4181	4207	4518	4546
		4AFLNTLN	4AFLNTLA	4AFL03LN	4AFL03LA	4AFL04LN	4AFL04LA
FFD73K.	66 20	\$3529	3555	3693	3720	3968	3994
	72 20	\$3579	3604	3803	3831	4142	4167
		4AFCNTLN	4AFCNTLA	4AFC03LN	4AFC03LA	4AFC04LN	4AFC04LA
FFD73K.	66 20	\$4029	4056	4194	4220	4469	4496
	72 20	\$4093	4119	4318	4345	4656	4682

Step 11. Case Finish

For 48" wide (48) or 60" wide (60) with laminate case/front (L), or laminate case/veneer front (C)

LBM	crisp linen <input type="checkbox"/>	+\$0
LBN	classic linen <input type="checkbox"/>	+\$0
LBP	casual linen <input type="checkbox"/>	+\$0

For 48" wide (48) or 60" wide (60) with laminate case/front (L), or laminate case/veneer front (C)

LBK	pewter mesh <input type="checkbox"/>	+\$0
LBL	steel mesh <input type="checkbox"/>	+\$0

Powered Wood Low Credenza,
Open with Drawers *continued*

Solid-Color Laminate

For 48" wide (48) or 60" wide (60) with laminate case/front (L), or laminate case/veneer front (C)

8Q	folkstone grey <input type="checkbox"/>	+\$0
91	white <input type="checkbox"/>	+\$0
98	studio white <input type="checkbox"/>	+\$0
CL	cool grey neutral <input type="checkbox"/>	+\$0
LU	soft white <input type="checkbox"/>	+\$0
WL	sandstone <input type="checkbox"/>	+\$0
WN	warm grey neutral <input type="checkbox"/>	+\$0

For 48" wide (48) or 60" wide (60) with laminate case/front (L), or laminate case/veneer front (C)

LBF	neutral twill <input type="checkbox"/>	+\$0
LBG	sarum twill <input type="checkbox"/>	+\$0
LBH	earthen twill <input type="checkbox"/>	+\$0
LBJ	graphite twill <input type="checkbox"/>	+\$0
LBQ	white twill <input type="checkbox"/>	+\$0

Wood-Grain Laminate

For 48" wide (48) or 60" wide (60) with laminate case/front (L), or laminate case/veneer front (C)

HM	natural maple <input type="checkbox"/>	+\$0
HP	light anigre <input type="checkbox"/>	+\$0
LBA	clear on ash	+\$0
LBB	oak on ash	+\$0
LBC	walnut on ash	+\$0
LBD	dark brown walnut	+\$0
LBR	phantom ecru	+\$0
LBS	phantom cocoa	+\$0
LBU	medium matte walnut	+\$0
LBV	warm grey teak	+\$0
LBE	medium red walnut	+\$0
76	light brown walnut <input type="checkbox"/>	+\$0
HX	aged cherry <input type="checkbox"/>	+\$0
HY	walnut on cherry <input type="checkbox"/>	+\$0

For 66" wide (66) or 72" wide (72) with laminate case/front (L), or laminate case/veneer front (C)

LBM	crisp linen <input type="checkbox"/>	+\$0
LBN	classic linen <input type="checkbox"/>	+\$0
LBP	casual linen <input type="checkbox"/>	+\$0

For 66" wide (66) or 72" wide (72) with laminate case/front (L), or laminate case/veneer front (C)

LBK	pewter mesh <input type="checkbox"/>	+\$0
LBL	steel mesh <input type="checkbox"/>	+\$0

Solid-Color Laminate

For 66" wide (66) or 72" wide (72) with laminate case/front (L), or laminate case/veneer front (C)

8Q	folkstone grey <input type="checkbox"/>	+\$0
91	white <input type="checkbox"/>	+\$0
98	studio white <input type="checkbox"/>	+\$0
CL	cool grey neutral <input type="checkbox"/>	+\$0
LU	soft white <input type="checkbox"/>	+\$0
WL	sandstone <input type="checkbox"/>	+\$0
WN	warm grey neutral <input type="checkbox"/>	+\$0

Step 12. Front Finish

For laminate case/front (L)

LBM	crisp linen <input type="checkbox"/>	+\$0
LBN	classic linen <input type="checkbox"/>	+\$0
LBP	casual linen <input type="checkbox"/>	+\$0

For laminate case/front (L)

LBK	pewter mesh <input type="checkbox"/>	+\$0
LBL	steel mesh <input type="checkbox"/>	+\$0

Solid-Color Laminate

For laminate case/front (L)

8Q	folkstone grey <input type="checkbox"/>	+\$0
91	white <input type="checkbox"/>	+\$0
98	studio white <input type="checkbox"/>	+\$0
CL	cool grey neutral <input type="checkbox"/>	+\$0
LU	soft white <input type="checkbox"/>	+\$0
WL	sandstone <input type="checkbox"/>	+\$0
WN	warm grey neutral <input type="checkbox"/>	+\$0

For laminate case/front (L)

LBF	neutral twill <input type="checkbox"/>	+\$0
LBG	sarum twill <input type="checkbox"/>	+\$0
LBH	earthen twill <input type="checkbox"/>	+\$0
LBJ	graphite twill <input type="checkbox"/>	+\$0
LBQ	white twill <input type="checkbox"/>	+\$0

Powered Wood Low Credenza, Open with Drawers *continued*

Wood-Grain Laminate

For laminate case/front (L)

HM	natural maple A	+\$0
HP	light anigre A	+\$0
LBA	clear on ash	+\$0
LBB	oak on ash	+\$0
LBC	walnut on ash	+\$0
LBD	dark brown walnut	+\$0
LBR	phantom ecru	+\$0
LBS	phantom cocoa	+\$0
LBU	medium matte walnut	+\$0
LBV	warm grey teak	+\$0
LBE	medium red walnut	+\$0
76	light brown walnut A	+\$0
HX	aged cherry A	+\$0
HY	walnut on cherry A	+\$0

Wood Veneer

For laminate case/veneer front (C)

2U	light brown walnut A	+\$0
40	dark brown walnut A	+\$0
ED	aged cherry A	+\$0
EK	medium red walnut A	+\$0
EW	medium matte walnut A	+\$0
ET	clear on ash A	+\$0
EV	walnut on ash A	+\$0
UL	natural maple A	+\$0
UX	walnut on cherry A	+\$0

Step 13. Top Finish

For 3/8" laminate top (03)

LBM	crisp linen A	+\$0
LBN	classic linen A	+\$0
LBP	casual linen A	+\$0

For 3/8" laminate top (03)

LBK	pewter mesh A	+\$0
LBL	steel mesh A	+\$0

Solid-Color Laminate

For 3/8" laminate top (03)

8Q	folkstone grey A	+\$0
91	white A	+\$0
98	studio white A	+\$0
CL	cool grey neutral A	+\$0
LU	soft white A	+\$0
WL	sandstone A	+\$0
WN	warm grey neutral A	+\$0

For 3/8" laminate top (03)

LBF	neutral twill A	+\$0
LBG	sarum twill A	+\$0
LBH	earthen twill A	+\$0
LBJ	graphite twill A	+\$0
LBQ	white twill A	+\$0

Wood-Grain Laminate

For 3/8" laminate top (03)

HM	natural maple A	+\$0
HP	light anigre A	+\$0
76	light brown walnut A	+\$0
LBA	clear on ash	+\$0
LBB	oak on ash	+\$0
LBC	walnut on ash	+\$0
LBD	dark brown walnut	+\$0
LBR	phantom ecru	+\$0
LBS	phantom cocoa	+\$0
LBU	medium matte walnut	+\$0
LBV	warm grey teak	+\$0
LBE	medium red walnut	+\$0
HX	aged cherry A	+\$0
HY	walnut on cherry A	+\$0

Wood Veneer

For 3/8" veneer top (04)

2U	light brown walnut A	+\$0
40	dark brown walnut A	+\$0
ED	aged cherry A	+\$0
EK	medium red walnut A	+\$0
EW	medium matte walnut A	+\$0
ET	clear on ash A	+\$0
EV	walnut on ash A	+\$0
UL	natural maple A	+\$0
UX	walnut on cherry A	+\$0

Powered Wood Low Credenza,
Open with Drawers *continued*

Step 14. Foot Finish

8Q	folkstone grey <input type="checkbox"/>	+\$0
98	studio white <input type="checkbox"/>	+\$0
WL	sandstone <input type="checkbox"/>	+\$0

Bright Sand Texture Paint

91	white <input type="checkbox"/>	+\$0
CL	cool grey neutral <input type="checkbox"/>	+\$0
G1	graphite <input type="checkbox"/>	+\$0
WN	warm grey neutral <input type="checkbox"/>	+\$0

Metallic Paint

CN	metallic champagne <input type="checkbox"/>	+\$0
EH	metallic bronze <input type="checkbox"/>	+\$0
MS	metallic silver <input type="checkbox"/>	+\$0

Step 15. Pull Finish

For arc pull (A.)

NH	brushed nickel <input type="checkbox"/>	+\$0
NK	black nickel <input type="checkbox"/>	+\$0

For bar pull (K.)

8Q	folkstone grey	+\$0
91	white	+\$0
98	studio white <input type="checkbox"/>	+\$0
G1	graphite <input type="checkbox"/>	+\$0
WL	sandstone <input type="checkbox"/>	+\$0
CN	metallic champagne <input type="checkbox"/>	+\$0
MS	metallic silver <input type="checkbox"/>	+\$0
79	green apple <input type="checkbox"/>	+\$15
MY3	yellow oxide <input type="checkbox"/>	+\$15
RO	red <input type="checkbox"/>	+\$15
TRQ	turquoise <input type="checkbox"/>	+\$15

Step 16. Counterweight

NO	no counterweight <input type="checkbox"/>	+\$0
CB	counterweight <input type="checkbox"/>	+\$70

Step 17. Lock Option

KA	keyed alike <input type="checkbox"/>	-\$10
KC	keyed differently, chrome <input type="checkbox"/>	+\$0
KD	keyed differently, black <input type="checkbox"/>	+\$0

Powered Wood Low Credenza,
Doors with Drawers

FFD74A
FFD74K

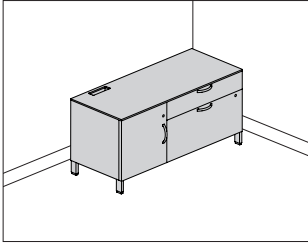

Product Information

Description

This powered credenza provides enclosed filing and storage and can be used freestanding, to support 1 end of a surface, or attached to a Canvas wall-based frame to support a frame run. It has a 3/8"-high laminate or veneer top and the choice of a laminate case and front, veneer case and front, or laminate case with veneer front. The credenza is available with 4"-high architectural feet with 1" leveling glides and has a positive interlock system that permits only 1 drawer to open at a time. Drawers have full-extension ball-bearing slides. The file drawer(s) accommodate side-to-side and front-to-back filing of letter-, legal, and A4-size hanging files. Connect™ power distributors with modular ends are ordered and installed separately.

Actual powered credenza widths are 47 3/4", 59 3/4", or 71 3/4"; actual depth is 19 7/8".

Notes

For additional product options, see Vary Easy Program in Appendices. Arc pull option (A.) conforms to guidelines of Americans with Disabilities Act (ADA).

Grain direction is vertical on veneer and wood-grain laminate fronts.

Credenza with 4"-high foot option (4) and 3/8" thin top can be used to support a Canvas wall-based frame. Order support bracket, low credenza-to-frame (FT292.) separately.

When using credenza to support 1 end of a surface, order 1 of the following products separately:

- Surface support, low credenza, adjustable height (FT299.)
- Surface support, low credenza, fixed height (FT298.)

To cover adjacent credenzas with a single top, specify credenzas with no top option (NT) and order credenza top (FM890.) separately.

Order optional wood credenza shelf (FF892.) separately.

To provide temporary guest seating on a credenza, order cushion top (FF891.) separately.

Order the following products separately:

- Connect - S310 electrical unit with connect modular connection (Y1329.)
- Connect - power entry, 4-circuit (Y1351.)
- Connect - junction block to junction block jumper, 4-circuit (Y1353.)
- Connect - H-block connector, 4-circuit (Y1354.H)

Powered credenzas must be ganged together.

For keyed-alike locks, see Keyed-Alike Information in Appendices.

Dimensions

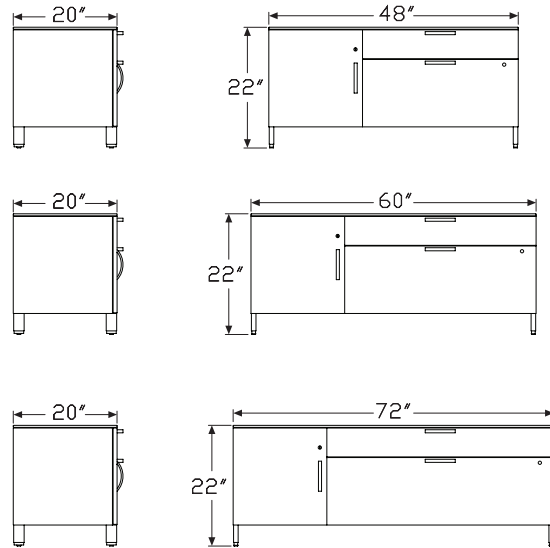

Powered Wood Low Credenza,
Doors with Drawers *continued*

Specification Information

Step 1.

FFD74 **A**

Step 2. Pull Type

A. arc pull **A**

K. bar pull **A**

Step 3. Width

48 48" wide **A**

60 60" wide **A**

72 72" wide **A**

Step 4. Depth

20 20" deep **A**

Step 5. Base/Foot Height

4 4"-high foot **A**

Step 6. Configuration

For 48" wide (48)

CE 30" box/file left, single door right **A**

CF single door left, 30" box/file right **A**

For 60" wide (60)

CG 30" box/file left, double doors right **A**

CH double doors left, 30" box/file right **A**

For 72" wide (72)

CM 36" box/file left, double doors right **A**

CN double doors left, 36" box/file right **A**

Step 7. Case/Front Material

L laminate case/front **A**

C laminate case/veneer front **A**

Step 8. Top

NT no top **A**

03 3/8" laminate top **A**

04 3/8" veneer top **A**

Step 9. Power Access Location

For single door left, 30" box/file right (CF), double doors left, 30" box/file right (CH), or double doors left, 36" box/file right (CN)

L left center access **A**

For 30" box/file left, single door right (CE), 30" box/file left, double doors right (CG), or 36" box/file left, double doors right (CM)

R right center access **A**

Prices for Steps 1-9.

	4CELNTR	4CELO3R	4CELO4R	4CECNTR	4CECO3R	4CECO4R
FFD74A. 48 20	\$3209	3346	3593	3342	3479	3727

	4CGLNTR	4CGL03R	4CGL04R	4CGCNTR	4CGC03R	4CGC04R
FFD74A. 60 20	\$3619	3783	4058	3752	3915	4191

	4CMLNTR	4CML03R	4CML04R	4CMCNTR	4CMC03R	4CMC04R
FFD74A. 72 20	\$3861	4080	4409	3993	4213	4543

	4CFLNTR	4CFL03L	4CFL04L	4CFNTR	4CFC03L	4CFC04L
FFD74A. 48 20	\$3209	3346	3593	3342	3479	3727

	4CHLNTL	4CHL03L	4CHL04L	4CHCNTL	4CHC03L	4CHC04L
FFD74A. 60 20	\$3861	4080	4409	3993	4213	4543

	4CNLNTL	4CNL03L	4CNL04L	4CNCNTL	4CNC03L	4CNC04L
FFD74A. 72 20	\$3861	4080	4409	3993	4213	4543

	4CELNTR	4CELO3R	4CELO4R	4CECNTR	4CECO3R	4CECO4R
FFD74K. 48 20	\$3209	3346	3593	3342	3479	3727

	4CGLNTR	4CGL03R	4CGL04R	4CGCNTR	4CGC03R	4CGC04R
FFD74K. 60 20	\$3619	3783	4058	3752	3915	4191

	4CMLNTR	4CML03R	4CML04R	4CMCNTR	4CMC03R	4CMC04R
FFD74K. 72 20	\$3861	4080	4409	3993	4213	4543

	4CFLNTR	4CFL03L	4CFL04L	4CFNTR	4CFC03L	4CFC04L
FFD74K. 48 20	\$3209	3346	3593	3342	3479	3727

	4CHLNTL	4CHL03L	4CHL04L	4CHCNTL	4CHC03L	4CHC04L
FFD74K. 60 20	\$3861	4080	4409	3993	4213	4543

	4CNLNTL	4CNL03L	4CNL04L	4CNCNTL	4CNC03L	4CNC04L
FFD74K. 72 20	\$3861	4080	4409	3993	4213	4543

Powered Wood Low Credenza,
Doors with Drawers *continued*

Step 10. Case Finish

For 48" wide (48) or 60" wide (60) with laminate case/front (L), or laminate case/veneer front (C)

LBM	crisp linen <input type="checkbox"/>	+\$0
LBN	classic linen <input type="checkbox"/>	+\$0
LBP	casual linen <input type="checkbox"/>	+\$0

For 48" wide (48) or 60" wide (60) with laminate case/front (L), or laminate case/veneer front (C)

LBK	pewter mesh <input type="checkbox"/>	+\$0
LBL	steel mesh <input type="checkbox"/>	+\$0

Solid-Color Laminate

For 48" wide (48) or 60" wide (60) with laminate case/front (L), or laminate case/veneer front (C)

8Q	folkstone grey <input type="checkbox"/>	+\$0
91	white <input type="checkbox"/>	+\$0
98	studio white <input type="checkbox"/>	+\$0
CL	cool grey neutral <input type="checkbox"/>	+\$0
LU	soft white <input type="checkbox"/>	+\$0
WL	sandstone <input type="checkbox"/>	+\$0
WN	warm grey neutral <input type="checkbox"/>	+\$0

For 48" wide (48) or 60" wide (60) with laminate case/front (L), or laminate case/veneer front (C)

LBF	neutral twill <input type="checkbox"/>	+\$0
LBG	sarum twill <input type="checkbox"/>	+\$0
LBH	earthen twill <input type="checkbox"/>	+\$0
LBJ	graphite twill <input type="checkbox"/>	+\$0
LBQ	white twill <input type="checkbox"/>	+\$0

Wood-Grain Laminate

For 48" wide (48) or 60" wide (60) with laminate case/front (L), or laminate case/veneer front (C)

HM	natural maple <input type="checkbox"/>	+\$0
HP	light anigre <input type="checkbox"/>	+\$0
LBA	clear on ash	+\$0
LBB	oak on ash	+\$0
LBC	walnut on ash	+\$0
LBD	dark brown walnut	+\$0
LBR	phantom ecru	+\$0
LBS	phantom cocoa	+\$0
LBU	medium matte walnut	+\$0
LBV	warm grey teak	+\$0
LBE	medium red walnut	+\$0
76	light brown walnut <input type="checkbox"/>	+\$0
HX	aged cherry <input type="checkbox"/>	+\$0
HY	walnut on cherry <input type="checkbox"/>	+\$0

For 72" wide (72) with laminate case/front (L), or laminate case/veneer front (C)

LBM	crisp linen <input type="checkbox"/>	+\$0
LBN	classic linen <input type="checkbox"/>	+\$0
LBP	casual linen <input type="checkbox"/>	+\$0

For 72" wide (72) with laminate case/front (L), or laminate case/veneer front (C)

LBK	pewter mesh <input type="checkbox"/>	+\$0
LBL	steel mesh <input type="checkbox"/>	+\$0

Solid-Color Laminate

For 72" wide (72) with laminate case/front (L), or laminate case/veneer front (C)

8Q	folkstone grey <input type="checkbox"/>	+\$0
91	white <input type="checkbox"/>	+\$0
98	studio white <input type="checkbox"/>	+\$0
CL	cool grey neutral <input type="checkbox"/>	+\$0
LU	soft white <input type="checkbox"/>	+\$0
WL	sandstone <input type="checkbox"/>	+\$0
WN	warm grey neutral <input type="checkbox"/>	+\$0

Step 11. Front Finish

For laminate case/front (L)

LBM	crisp linen <input type="checkbox"/>	+\$0
LBN	classic linen <input type="checkbox"/>	+\$0
LBP	casual linen <input type="checkbox"/>	+\$0

Powered Wood Low Credenza,
Doors with Drawers *continued*

For laminate case/front (L)

LBK	pewter mesh <input type="checkbox"/>	+\$0
LBL	steel mesh <input type="checkbox"/>	+\$0

Solid-Color Laminate

For laminate case/front (L)

8Q	folkstone grey <input type="checkbox"/>	+\$0
91	white <input type="checkbox"/>	+\$0
98	studio white <input type="checkbox"/>	+\$0
CL	cool grey neutral <input type="checkbox"/>	+\$0
LU	soft white <input type="checkbox"/>	+\$0
WL	sandstone <input type="checkbox"/>	+\$0
WN	warm grey neutral <input type="checkbox"/>	+\$0

For laminate case/front (L)

LBF	neutral twill <input type="checkbox"/>	+\$0
LBG	sarum twill <input type="checkbox"/>	+\$0
LBH	earthen twill <input type="checkbox"/>	+\$0
LBJ	graphite twill <input type="checkbox"/>	+\$0
LBQ	white twill <input type="checkbox"/>	+\$0

Wood-Grain Laminate

For laminate case/front (L)

HM	natural maple <input type="checkbox"/>	+\$0
HP	light anigre <input type="checkbox"/>	+\$0
LBA	clear on ash	+\$0
LBB	oak on ash	+\$0
LBC	walnut on ash	+\$0
LBD	dark brown walnut	+\$0
LBR	phantom ecru	+\$0
LBS	phantom cocoa	+\$0
LBU	medium matte walnut	+\$0
LBV	warm grey teak	+\$0
LBE	medium red walnut	+\$0
76	light brown walnut <input type="checkbox"/>	+\$0
HX	aged cherry <input type="checkbox"/>	+\$0
HY	walnut on cherry <input type="checkbox"/>	+\$0

Wood Veneer

For laminate case/veneer front (C)

2U	light brown walnut <input type="checkbox"/>	+\$0
40	dark brown walnut <input type="checkbox"/>	+\$0
ED	aged cherry <input type="checkbox"/>	+\$0
EK	medium red walnut <input type="checkbox"/>	+\$0
EW	medium matte walnut <input type="checkbox"/>	+\$0
ET	clear on ash <input type="checkbox"/>	+\$0
EV	walnut on ash <input type="checkbox"/>	+\$0
UL	natural maple <input type="checkbox"/>	+\$0
UX	walnut on cherry <input type="checkbox"/>	+\$0

Step 12. Top Finish

For 3/8" laminate top (o3)

LBM	crisp linen <input type="checkbox"/>	+\$0
LBN	classic linen <input type="checkbox"/>	+\$0
LBP	casual linen <input type="checkbox"/>	+\$0

For 3/8" laminate top (o3)

LBK	pewter mesh <input type="checkbox"/>	+\$0
LBL	steel mesh <input type="checkbox"/>	+\$0

Solid-Color Laminate

For 3/8" laminate top (o3)

8Q	folkstone grey <input type="checkbox"/>	+\$0
91	white <input type="checkbox"/>	+\$0
98	studio white <input type="checkbox"/>	+\$0
CL	cool grey neutral <input type="checkbox"/>	+\$0
LU	soft white <input type="checkbox"/>	+\$0
WL	sandstone <input type="checkbox"/>	+\$0
WN	warm grey neutral <input type="checkbox"/>	+\$0

For 3/8" laminate top (o3)

LBF	neutral twill <input type="checkbox"/>	+\$0
LBG	sarum twill <input type="checkbox"/>	+\$0
LBH	earthen twill <input type="checkbox"/>	+\$0
LBJ	graphite twill <input type="checkbox"/>	+\$0
LBQ	white twill <input type="checkbox"/>	+\$0

Powered Wood Low Credenza, Doors with Drawers *continued*

Wood-Grain Laminate

For 3/8" laminate top (03)

HM	natural maple [A]	+\$0
HP	light anigre [A]	+\$0
LBA	clear on ash	+\$0
LBB	oak on ash	+\$0
LBC	walnut on ash	+\$0
LBD	dark brown walnut	+\$0
LBR	phantom ecru	+\$0
LBS	phantom cocoa	+\$0
LBU	medium matte walnut	+\$0
LBV	warm grey teak	+\$0
LBE	medium red walnut	+\$0
76	light brown walnut [A]	+\$0
HX	aged cherry [A]	+\$0
HY	walnut on cherry [A]	+\$0

Wood Veneer

For 3/8" veneer top (04)

2U	light brown walnut [A]	+\$0
40	dark brown walnut [A]	+\$0
ED	aged cherry [A]	+\$0
EK	medium red walnut [A]	+\$0
EW	medium matte walnut [A]	+\$0
ET	clear on ash [A]	+\$0
EV	walnut on ash [A]	+\$0
UL	natural maple [A]	+\$0
UX	walnut on cherry [A]	+\$0

Step 13. Foot Finish

8Q	folkstone grey [A]	+\$0
98	studio white [A]	+\$0
WL	sandstone [A]	+\$0

Bright Sand Texture Paint

91	white [A]	+\$0
CL	cool grey neutral [A]	+\$0
G1	graphite [A]	+\$0
WN	warm grey neutral [A]	+\$0

Metallic Paint

CN	metallic champagne [A]	+\$0
EH	metallic bronze [A]	+\$0
MS	metallic silver [A]	+\$0

Step 14. Pull Finish

For arc pull (A.)

NH	brushed nickel [A]	+\$0
NK	black nickel [A]	+\$0

For bar pull (K.)

8Q	folkstone grey	+\$0
91	white	+\$0
98	studio white [A]	+\$0
G1	graphite [A]	+\$0
WL	sandstone [A]	+\$0
CN	metallic champagne [A]	+\$0
MS	metallic silver [A]	+\$0
79	green apple [A]	+\$15
MY3	yellow oxide [A]	+\$15
RO	red [A]	+\$15
TRQ	turquoise [A]	+\$15

Step 15. Counterweight

NO	no counterweight [A]	+\$0
CB	counterweight [A]	+\$70

Step 16. Lock Option

KA	keyed alike [A]	-\$10
KC	keyed differently, chrome [A]	+\$0
KD	keyed differently, black [A]	+\$0

Powered Storage Distributor Cover

FPS911

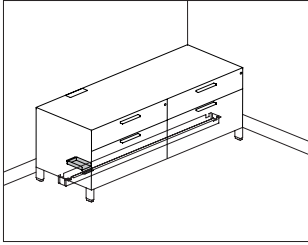

Product Information

Description

This distributor cover attaches to a metal or wood Canvas Office Landscape® powered low credenza. It is used in conjunction with a powered storage cable cover and Connect™ components to comply with UL1286 listing. Finish is black.

Notes

Order the following products separately:

- Canvas powered metal low credenza (FMP72, FMP73, FMP74)
- Canvas powered wood low credenza (FFD72, FFD73, FFD74)
- Connect - S310 electrical unit with connect modular connection (Y1329.)
- Connect - power entry, 4-circuit (Y1351.)
- Connect - junction block to junction block jumper, 4-circuit (Y1353.)
- Connect - H-block connector, 4-circuit (Y1354.H)
- Powered storage cable cover (FPS910.)

Dimensions

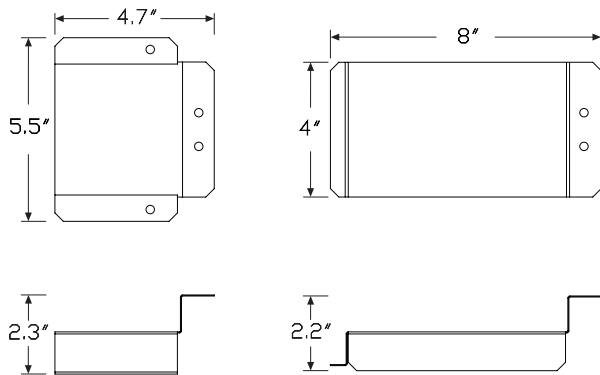

Specification Information

Step 1.

FPS911. A

Step 2. Material

F for use with wood powered low credenza A

M for use with metal powered low credenza A

Prices for Steps 1-2.

FPS911. F	\$52
M	\$52

Connect™ - S310 Electrical Unit Y1329. with Connect Modular Connection

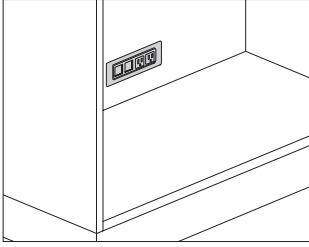

Canvas Office Landscape® Wood Case Credenzas

Product Information

Description
This electrical distributor provides power to a lateral file, low credenza, or storage case with a Connect™ 4-circuit modular connector. It can be top surface mounted flush or vertically mounted in the false back of a cabinet. A voice/data adapter kit is included, allowing the data openings to accept various manufacturers' couplers and jacks. Attachment hardware is included. Product is UL listed.

Notes

Field cutting of surface may be required. Information on surface cutout size is included on instruction sheet.

Silver option (OI) and white option (OJ) have painted metal trim with white plastic simplex/data interiors. Black option (OH) has black painted trim with black plastic simplex/data interior.

Modular electrical connectors can only connect to Connect 4-circuit modular power system.

Order the following products separately:

- Canvas powered metal low credenza (FMP72A., FMP72K., FMP73A., FMP73K., FMP74A., FMP74K.)
- Canvas powered wood low credenza (FFD72A., FFD72K., FFD73A., FFD73K., FFD74A., FFD74K.)
- Meridian powered storage case (PSC-, PS6-, PSAM-, PSAV-, PSKM-, PSKV-)
- Meridian powered storage lateral file (PS26-, PS2AM, PS2AV, PS2KM, PS2KV)
- Connect - power entry, 4-circuit (Y1351.)
- Connect - junction block to junction block jumper, 4-circuit (Y1353.)
- Connect - block connector, 4-circuit (Y1354.)
- Other Connect 4-circuit modular power components as required

For Canvas powered storage, order Connect - conduit clamp (Y1339.) separately.

Dimensions

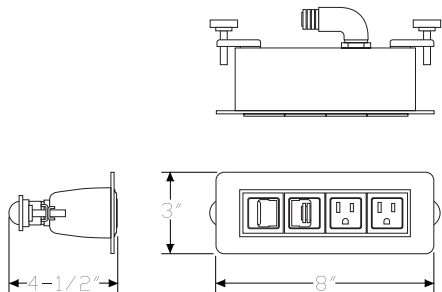

Specification Information

Step 1.

Y1329.

Step 2. Configuration

3	2 simplex receptacles, 2 data openings
8	3 simplex receptacles, 1 data opening

Step 3. Power Type

E	4 circuit circuit 1
F	4 circuit circuit 2
G	4 circuit circuit 3
H	4 circuit circuit 4

Step 4. Cord/Conduit Length

02	2' conduit
03	3' conduit
04	4' conduit
06	6' conduit
10	10' conduit

Prices for Steps 1-4.

		02	03	04	06	10
Y1329. 3	E	\$331	340	349	371	411
	F	\$331	340	349	371	411
	G	\$331	340	349	371	411
	H	\$331	340	349	371	411
8	E	\$346	355	368	386	426
	F	\$346	355	368	386	426
	G	\$346	355	368	386	426
	H	\$346	355	368	386	426

Step 5. Finish

OH	black					+\$0
OI	silver					+\$0
OJ	white					+\$0

Connect™-Power Entry, 4-Circuit Y1351.

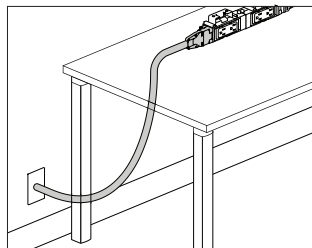

Product Information

Description

This power entry connects a building's electrical from a wall, floor, or column to the end of a 4-circuit dual junction block power kit or junction block and distributes up to 4 20-amp circuits. UL 183 listed, CUL Certified.

Notes

Connect™ modular power products are not compatible with electrical components used in Herman Miller systems or desking product lines.

Power entry can be field cut to the appropriate length.

For San Francisco, specify 3/8" flex metallic conduit option (C).

Finish color on liquid tight conduit is black. Finish color on metallic conduit is silver.

A licensed electrician must wire the power entry to the building's electrical system.

Dimensions

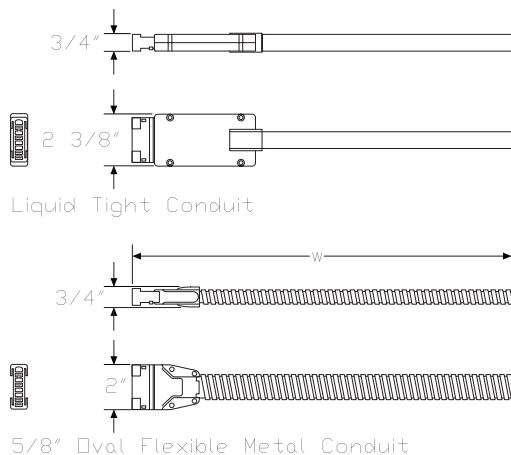

Specification Information

Step 1.

Y1351.

Step 2. Length

06	6' long
12	12' long
18	18' long
24	24' long

Step 3. Conduit Type

L	liquid tight conduit
C	3/8" flex metallic conduit

Prices for Steps 1-3.

	L	C
Y1351. 06	\$152	152
12	\$217	217
18	\$285	285
24	\$365	365

Connect™-Junction Block to Junction Block Jumper, 4-Circuit

Y1353.

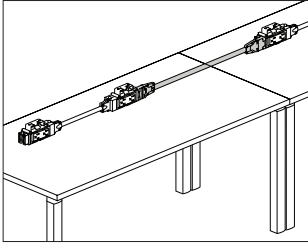

Product Information

Description

This power jumper distributes up to 4 20-amp circuits between 2 power kits or junction blocks and is available as adjustable or non-adjustable. The adjustable jumper allows 1 end of the jumper to extend an additional 3" when connecting to components under an adjacent desk or table. UL 183 listed, CUL Certified.

Notes

Connect™ modular power products are not compatible with electrical components used in Herman Miller systems or desking product lines. When routing power to an adjacent desk or table, surfaces must be ganged together. Order ganging bracket kit (Y1338.) separately. When connecting dual junction block power kits (Y1350.) between adjacent surfaces in a linear run, specify 24"-wide jumper. When connecting dual junction block power kits (Y1350.) at the outside corner of 2 24"-deep surfaces at 90°, specify 42"-wide jumper. When connecting dual junction block power kits (Y1350.) at the outside corner of 2 30"-deep surfaces at 90°, specify 48"-wide jumper. When connecting dual junction block power kits (Y1350.) at the outside corner of 1 30"-deep and 1 24"-deep surface, specify 48"-wide jumper. When connecting dual junction block power kits (Y1350.) at the inside corner of 2 24"- or 30"-deep surfaces, specify 30"-wide jumper.

Finish on 5/8" oval metallic conduit is silver.

Order the following products separately:

- Conduit clamps (Y1339.)
- Dual junction block power kit, 4-circuit (Y1350.) or junction block, 4-circuit (Y1358.)
- Duplex receptacle, 4-circuit (Y1355.) - for junction block, 4-circuit
- Junction block bracket, 4-circuit (Y1357.) - for junction block, 4-circuit
- Power entry, 4-circuit (Y1351.)

Dimensions

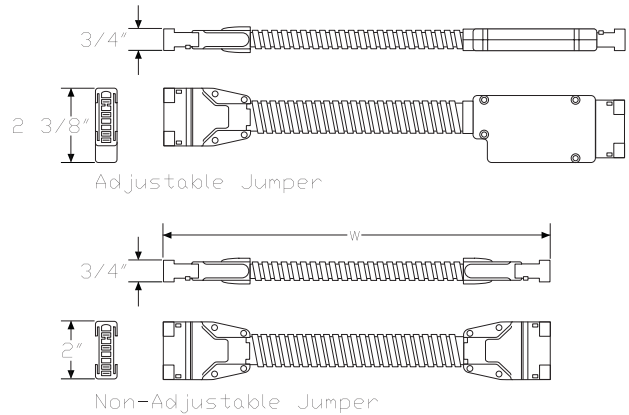

Connect™-Junction Block to Junction Block Jumper, 4-Circuit

continued

Specification Information

Step 1.

Y1353.

Step 2. Width

12	12" wide
18	18" wide
24	24" wide
30	30" wide
36	36" wide
42	42" wide
48	48" wide
54	54" wide
60	60" wide
66	66" wide
72	72" wide
78	78" wide
84	84" wide
90	90" wide
108	108" wide
120	120" wide
132	132" wide
144	144" wide

Step 3. Type

A	adjustable jumper
N	nonadjustable jumper

Prices for Steps 1-3.

	A	N
Y1353. 12	\$77	77
18	\$82	82
24	\$88	88
30	\$94	94
36	\$99	99
42	\$104	104
48	\$111	111
54	\$116	116
60	\$122	122
66	\$127	127
72	\$132	132
78	\$138	138
84	\$143	143
90	\$150	150
108	\$166	166
120	\$176	176
132	\$188	188
144	\$200	200

Canvas Office Landscape® Wood Case Credenzas

Connect™-Block Connector, 4-Circuit

Y1354.

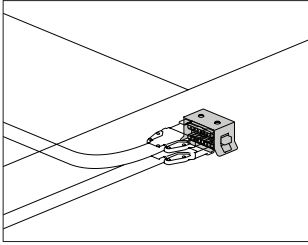

Product Information

Description

This block connects components together to distribute power. The H-block connector connects jumpers together at 2-, 3-, and 4-way connection points, or distributes power from a power entry to multiple components. The receptacle-to-receptacle connectors connect 2 junction blocks together. Finish is black. Attachment hardware included. UL 183 listed, CUL Certified.

Notes

Connect™ modular power products are not compatible with electrical components used in Herman Miller systems or desking product lines. When routing power to an adjacent desk or table, surfaces must be ganged together. Order ganging bracket kit (Y1338.) separately.

Dimensions

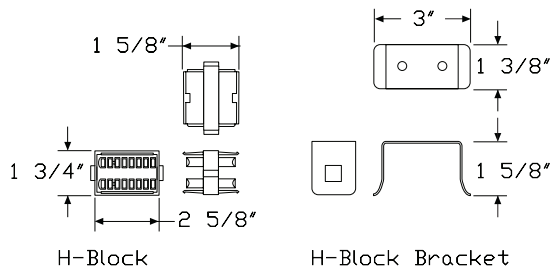

H-Block

H-Block Bracket

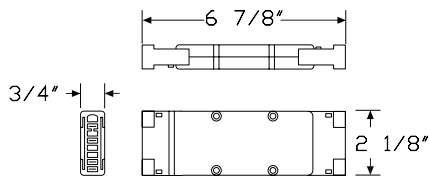

Receptacle-to-Receptacle Block Connector

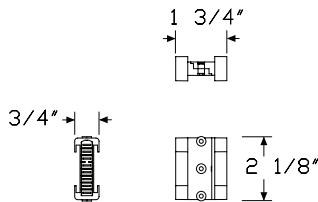

Short Receptacle-to-Receptacle Block Connector

Specification Information

Step 1.

Y1354.

Step 2. Connector Type

- H** H-block connector
- S** short receptacle-to-receptacle block connector A
- R** receptacle-to-receptacle block connector

Prices for Steps 1-2.

Y1354. H	\$42
S	\$52
R	\$54

Open Shelf Organizer

FF900.

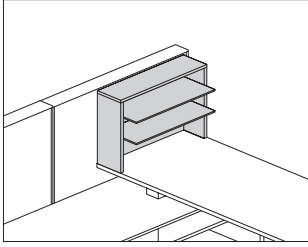

Product Information

Description

This organizer sits on a surface or credenza to provide open storage and organization of small items. It has a laminate or veneer case with aluminum shelves.

Notes

For additional product options, see Vary Easy Program in Appendices. 24", 30", and 36" widths match the depth of peninsula surfaces; 23" and 29" widths match the depth of standard surfaces. Order open shelf organizer divider (FF901.) separately.

Dimensions

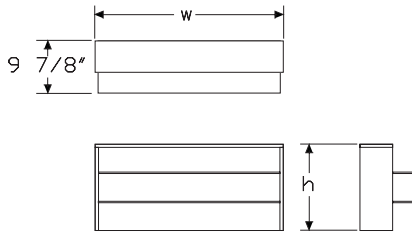

Specification Information

Step 1.

FF900. A

Step 2. Height

- 13** 12 1/2" high A
- 17** 16 1/2" high A
- 24** 23 1/2" high A

Step 3. Width

- 23** 23" wide A
- 24** 24" wide A
- 29** 29" wide A
- 30** 30" wide A
- 36** 36" wide A

Step 4. Case Material

- L** laminate A
- W** veneer A

Prices for Steps 1-4.

			L	W
FF900. 13	23		\$774	1160
	24		\$774	1160
	29		\$802	1226
	30		\$802	1226
	36		\$834	1293
17	23		\$862	1343
	24		\$862	1343
	29		\$892	1406
	30		\$892	1406
	36		\$921	1471
24	23		\$951	1520
	24		\$951	1520
	29		\$980	1587
	30		\$980	1587
	36		\$1008	1653

Step 5. Top/Case/Edge Finish

Solid-Color Laminate

For laminate (L)

8Q	folkstone grey <input type="checkbox"/>	+\$0
91	white <input type="checkbox"/>	+\$0
98	studio white	+\$0
CL	cool grey neutral <input type="checkbox"/>	+\$0
LU	soft white <input type="checkbox"/>	+\$0
WL	sandstone <input type="checkbox"/>	+\$0
WN	warm grey neutral <input type="checkbox"/>	+\$0

Linen Laminate

For laminate (L)

LBM	crisp linen	+\$0
LBN	classic linen	+\$0
LBP	casual linen	+\$0

Mesh Laminate

For laminate (L)

LBK	pewter mesh	+\$0
LBL	steel mesh	+\$0

Twill Laminate

For laminate (L)

LBF	neutral twill	+\$0
LBG	sarum twill	+\$0
LBH	earthen twill	+\$0
LBJ	graphite twill	+\$0
LBQ	white twill	+\$0

Wood-Grain Laminate

For laminate (L)

HM	natural maple <input type="checkbox"/>	+\$0
HP	light anigre <input type="checkbox"/>	+\$0
LBA	clear on ash	+\$0
LBR	phantom ecru	+\$0
LBS	phantom cocoa	+\$0
LBU	medium matte walnut	+\$0
LBV	warm grey teak	+\$0
LBB	oak on ash	+\$0
LBC	walnut on ash	+\$0
LBD	dark brown walnut	+\$0
LBE	medium red walnut	+\$0
76	light brown walnut <input type="checkbox"/>	+\$0
HX	aged cherry <input type="checkbox"/>	+\$0
HY	walnut on cherry <input type="checkbox"/>	+\$0

Wood Veneer

For veneer (W)

2U	light brown walnut <input type="checkbox"/>	+\$0
40	dark brown walnut <input type="checkbox"/>	+\$0
ED	aged cherry <input type="checkbox"/>	+\$0
EK	medium red walnut <input type="checkbox"/>	+\$0
EW	medium matte walnut <input type="checkbox"/>	+\$0
ET	clear on ash <input type="checkbox"/>	+\$0
EU	oak on ash <input type="checkbox"/>	+\$0
EV	walnut on ash <input type="checkbox"/>	+\$0
UL	natural maple <input type="checkbox"/>	+\$0
UX	walnut on cherry <input type="checkbox"/>	+\$0

Step 6. Shelf Finish

Anodized Aluminum

AN	clear anodized aluminum <input type="checkbox"/>	+\$0
-----------	--	------

Open Shelf Organizer, Divider

FF901.

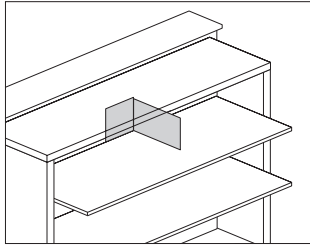

Product Information

Description

This divider fits on an open shelf organizer to divide shelf space.
Package contains 2.

Notes

Order open shelf organizer (FF900.) separately.

Dimensions

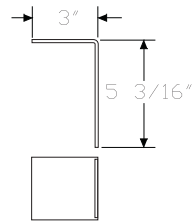

Specification Information

Step 1.

FF901. A \$119

Step 2. Surface Finish

AN clear anodized aluminum A +\$0

Open Shelf Organizer Attachment Bracket FF902.

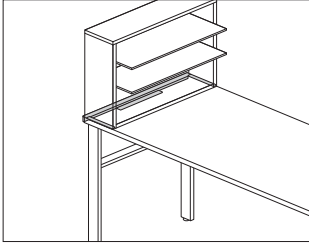

Product Information

Description
 This bracket attaches to the bottom of the open shelf organizer (FF900.) and secures it to the end of a work surface. It is used in applications where the open shelf organizer is not placed up against a frame or architectural wall.

Notes
 Specify bracket width to match open shelf organizer width.

Dimensions

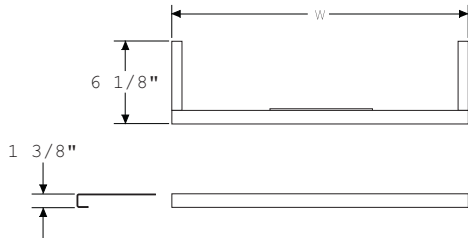

Specification Information

Step 1.

FF902. A

Step 2. Width

- 23** 23" wide A
- 24** 24" wide A
- 29** 29" wide A
- 30** 30" wide A
- 36** 36" wide A

Prices for Steps 1-2.

FF902. 23	\$193
24	\$193
29	\$203
30	\$203
36	\$215

Step 3. Finish

8Q folkstone grey <input type="checkbox"/> A	+\$0
91 white <input type="checkbox"/> A	+\$0
98 studio white <input type="checkbox"/> A	+\$0
CL cool grey neutral <input type="checkbox"/> A	+\$0
LU soft white <input type="checkbox"/> A	+\$0
WL sandstone <input type="checkbox"/> A	+\$0
WN warm grey neutral <input type="checkbox"/> A	+\$0

Canvas Office Landscape® Freestanding and Surface Attached Storage

Freestanding Storage

Attaching Storage

Attaching (Legacy Products)

Accessories

Accessories (Legacy Products)

Canvas Cabinet/Wall Attachment Bracket FV692.

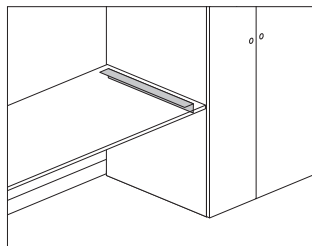

Product Information

Description

This bracket attaches 1 end of a surface to a Canvas wood vertical storage cabinet or architectural wall, eliminating the need for a support leg. Finish is black. Attachment hardware included.

Notes

Supports a 20" or 24" deep surface.

20" deep surface can be attached to a 20" or 24" deep wood vertical storage cabinet or architectural wall.

24" deep surface can be attached to a 24" deep wood vertical storage cabinet or architectural wall.

Dimensions

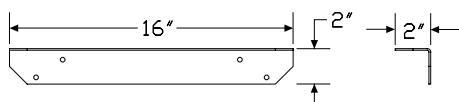

Specification Information

Step 1.

FV692.

\$66

Bookcase Hutch, Storage Attached

FV454.

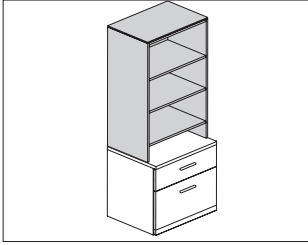

Canvas Office Landscape® Attaching Storage

Product Information

Description

This bookcase hutch attaches onto a low or high credenza surface with 1 1/4" top to provide open or enclosed storage. It is available in 2 heights: 57" high and 68" high. 16"-wide and 24"-wide hutches have a single door hinged left or right; 30", 36" and 42"-wide hutches have symmetrical doors. Bookcase hutch doors have touch latches and optional locks.

Notes

Align like components next to like units: Finished case units with other finished case units, thin top units with other thin top units, 2 1/4" base storage units with other 2 1/4" base storage, and 4" foot storage with other 4" foot storage.

Hutch case is available in laminate or veneer; doors in laminate, veneer, or back-painted glass; 3/8" thin top in laminate or veneer.

Glass doors are back-painted and writable with dry-erase marker. Glass doors cannot lock.

Grain direction is vertical on veneer, wood-grain, and patterned laminate case and fronts.

Storage compartment has adjustable shelves that adjust in 1 1/4" increments.

Hutch matches style of wood overhead storage cabinet, open (FV43C), overhead storage cabinet, hinged doors (FV43H), or overhead storage cabinet, sliding doors (FV43S).

Hutch is available with a finished case top (T), 3/8"-thick laminate top (3), and 3/8"-thick veneer top (4). The hutch with finished case top aligns with the top of the bead on a frame attached tile. Adding a thin top increases overall height of hutch 1/2".

Actual case depths are 14 3/4" (15) and 19 7/8" (20).

- 15" deep (15) matches depth of overhead storage unit (FV43x.)
- 20" deep (20) matches depth of Canvas lower storage components

Actual case widths are 15 5/8" (16), 23 7/8" (24), 29 7/8" (30), 35 7/8" (36), and 41 7/8" (42).

- 15 5/8" wide (16) matches Canvas wood pedestal drawer body.

Shelves vary based on height and base attachment option:

57" low credenza (2 1/4" base and 4" foot) — 2 adjustable shelves

57" high credenza (2 1/4" base) — 1 adjustable shelf

68" low credenza (2 1/4" base and 4" foot) — 3 adjustable shelves

68" high credenza (2 1/4" base) — 2 adjustable shelves

Dimensional illustration does not include all possible configurations.

For keyed-alike locks, see Keyed-Alike Information in appendices.

Dimensions

15 5/8", 24"



ND



ND(side)

15 5/8", 24"

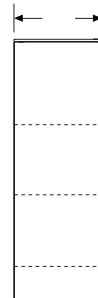

BL

15 5/8", 24"

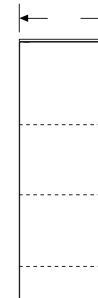

BR

30", 36", 42"

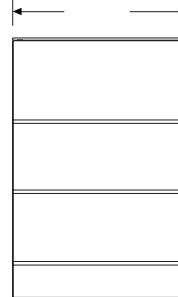

ND

30", 36", 42"

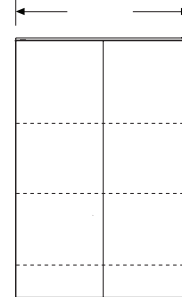

BD

Bookcase Hutch, Storage

Attached *continued*

Specification Information

Step 1.

FV454. A

Step 2. Base Attachment

LC2	low credenza, 2 ¹ / ₄ "-high base with 1 ¹ / ₄ " top	A	+\$150
LC4	low credenza, 4"-high foot with 1 ¹ / ₄ " top	A	+\$150
HC2	high credenza, 2 ¹ / ₄ "-high base with 1 ¹ / ₄ " top	A	+\$0

Step 3. Datum Height

6	57" high	A	+\$450
7	68" high	A	+\$600

Step 4. Width

16	15 ⁵ / ₈ " wide	A	+\$350
24	24" wide	A	+\$400
30	30" wide	A	+\$450
36	36" wide	A	+\$550
42	42" wide	A	+\$750

Step 5. Depth

15	15" deep	A	+\$200
20	20" deep	A	+\$250

Step 6. Configuration

For 15⁵/₈" wide (16) or 24" wide (24)

ND	open bookcase	A	+\$0
BL	bookcase with left-hinged door	A	+\$250
BR	bookcase with right-hinged door	A	+\$250

For 30" wide (30), 36" wide (36), or 42" wide (42)

ND	open bookcase	A	+\$0
BD	bookcase with two symmetrical doors	A	+\$325

Step 7. Case Material

For 15⁵/₈" wide (16)

L	laminated	A	+\$0
W	veneered	A	+\$580

For 24" wide (24)

L	laminated	A	+\$0
W	veneered	A	+\$956

For 30" wide (30)

L	laminated	A	+\$0
W	veneered	A	+\$1217

For 36" wide (36)

L	laminated	A	+\$0
W	veneered	A	+\$1493

For 42" wide (42)

L	laminated	A	+\$0
W	veneered	A	+\$1770

Step 8. Door Material

For 15⁵/₈" wide (16) with bookcase with left-hinged door (BL) or bookcase with right-hinged door (BR)

L	laminated	A	+\$0
W	veneered	A	+\$1035
G	glass	A	+\$881

For 24" wide (24) with bookcase with left-hinged door (BL) or bookcase with right-hinged door (BR)

L	laminated	A	+\$0
W	veneered	A	+\$1955
G	glass	A	+\$1381

For 30" wide (30) with bookcase with two symmetrical doors (BD)

L	laminated	A	+\$200
W	veneered	A	+\$2438
G	glass	A	+\$1762

For 36" wide (36) with bookcase with two symmetrical doors (BD)

L	laminated	A	+\$408
W	veneered	A	+\$2863
G	glass	A	+\$2143

For 42" wide (42) with bookcase with two symmetrical doors (BD)

L	laminated	A	+\$618
W	veneered	A	+\$3628
G	glass	A	+\$2500

Step 9. Top

T	finished case top	A	+\$0
3	3/8" laminate thin top	A	+\$150
4	3/8" veneer thin top	A	+\$300

Bookcase Hutch, Storage Attached *continued*

Step 10. Lock

For laminate (L) or veneer (W)

L	lock <input type="checkbox"/>	+\$0
N	no lock <input type="checkbox"/>	+\$0

For glass (G)

N	no lock <input type="checkbox"/>	+\$0
----------	----------------------------------	------

Step 11. Case/Edge Finish

For laminate (L)

76	light brown walnut <input type="checkbox"/>	+\$0
8Q	folkstone grey <input type="checkbox"/>	+\$0
91	white <input type="checkbox"/>	+\$0
98	studio white <input type="checkbox"/>	+\$0
CL	cool grey neutral <input type="checkbox"/>	+\$0
HM	natural maple <input type="checkbox"/>	+\$0
HP	light anigre <input type="checkbox"/>	+\$0
HX	aged cherry <input type="checkbox"/>	+\$0
HY	walnut on cherry <input type="checkbox"/>	+\$0
LA	light ash <input type="checkbox"/>	+\$0
LBA	clear on ash <input type="checkbox"/>	+\$0
LBR	phantom ecru <input type="checkbox"/>	+\$0
LBS	phantom cocoa <input type="checkbox"/>	+\$0
LBU	medium matte walnut <input type="checkbox"/>	+\$0
LBV	warm grey teak <input type="checkbox"/>	+\$0
LBB	oak on ash <input type="checkbox"/>	+\$0
LBC	walnut on ash <input type="checkbox"/>	+\$0
LBD	dark brown walnut <input type="checkbox"/>	+\$0
LBE	medium red walnut <input type="checkbox"/>	+\$0
LBF	neutral twill <input type="checkbox"/>	+\$0
LBG	sarum twill <input type="checkbox"/>	+\$0
LBH	earthen twill <input type="checkbox"/>	+\$0
LBJ	graphite twill <input type="checkbox"/>	+\$0
LBK	pewter mesh <input type="checkbox"/>	+\$0
LBL	steel mesh <input type="checkbox"/>	+\$0
LBM	crisp linen <input type="checkbox"/>	+\$0
LBN	classic linen <input type="checkbox"/>	+\$0
LBP	casual linen <input type="checkbox"/>	+\$0
LBQ	white twill <input type="checkbox"/>	+\$0
LU	soft white <input type="checkbox"/>	+\$0
WL	sandstone <input type="checkbox"/>	+\$0
WN	warm grey neutral <input type="checkbox"/>	+\$0

For veneer (W)

2U	light brown walnut <input type="checkbox"/>	+\$0
40	dark brown walnut <input type="checkbox"/>	+\$0
ED	aged cherry <input type="checkbox"/>	+\$0
EK	medium red walnut <input type="checkbox"/>	+\$0
EW	medium matte walnut <input type="checkbox"/>	+\$0
ET	clear on ash <input type="checkbox"/>	+\$0
EU	oak on ash <input type="checkbox"/>	+\$0
EV	walnut on ash <input type="checkbox"/>	+\$0
UL	natural maple <input type="checkbox"/>	+\$0
UX	walnut on cherry <input type="checkbox"/>	+\$0

Step 12. Door/Edge Finish

For laminate (L)

76	light brown walnut <input type="checkbox"/>	+\$0
8Q	folkstone grey <input type="checkbox"/>	+\$0
91	white <input type="checkbox"/>	+\$0
98	studio white <input type="checkbox"/>	+\$0
CL	cool grey neutral <input type="checkbox"/>	+\$0
HM	natural maple <input type="checkbox"/>	+\$0
HP	light anigre <input type="checkbox"/>	+\$0
HX	aged cherry <input type="checkbox"/>	+\$0
HY	walnut on cherry <input type="checkbox"/>	+\$0
LA	light ash <input type="checkbox"/>	+\$0
LBA	clear on ash <input type="checkbox"/>	+\$0
LBR	phantom ecru <input type="checkbox"/>	+\$0
LBS	phantom cocoa <input type="checkbox"/>	+\$0
LBU	medium matte walnut <input type="checkbox"/>	+\$0
LBV	warm grey teak <input type="checkbox"/>	+\$0
LBB	oak on ash <input type="checkbox"/>	+\$0
LBC	walnut on ash <input type="checkbox"/>	+\$0
LBD	dark brown walnut <input type="checkbox"/>	+\$0
LBE	medium red walnut <input type="checkbox"/>	+\$0
LBF	neutral twill <input type="checkbox"/>	+\$0
LBG	sarum twill <input type="checkbox"/>	+\$0
LBH	earthen twill <input type="checkbox"/>	+\$0
LBJ	graphite twill <input type="checkbox"/>	+\$0
LBK	pewter mesh <input type="checkbox"/>	+\$0
LBL	steel mesh <input type="checkbox"/>	+\$0
LBM	crisp linen <input type="checkbox"/>	+\$0
LBN	classic linen <input type="checkbox"/>	+\$0
LBP	casual linen <input type="checkbox"/>	+\$0
LBQ	white twill <input type="checkbox"/>	+\$0
LU	soft white <input type="checkbox"/>	+\$0
WL	sandstone <input type="checkbox"/>	+\$0
WN	warm grey neutral <input type="checkbox"/>	+\$0

Bookcase Hutch, Storage Attached *continued*

For veneer (W)

2U	light brown walnut <input type="checkbox"/>	+\$0
40	dark brown walnut <input type="checkbox"/>	+\$0
ED	aged cherry <input type="checkbox"/>	+\$0
EK	medium red walnut <input type="checkbox"/>	+\$0
EW	medium matte walnut <input type="checkbox"/>	+\$0
ET	clear on ash <input type="checkbox"/>	+\$0
EU	oak on ash <input type="checkbox"/>	+\$0
EV	walnut on ash <input type="checkbox"/>	+\$0
UL	natural maple <input type="checkbox"/>	+\$0
UX	walnut on cherry <input type="checkbox"/>	+\$0

For glass (G)

8Q	folkstone grey <input type="checkbox"/>	+\$0
91	white <input type="checkbox"/>	+\$0
98	studio white <input type="checkbox"/>	+\$0

Step 13. Top/Edge Finish

For 3/8" laminate thin top (3)

76	light brown walnut <input type="checkbox"/>	+\$0
8Q	folkstone grey <input type="checkbox"/>	+\$0
91	white <input type="checkbox"/>	+\$0
98	studio white <input type="checkbox"/>	+\$0
CL	cool grey neutral <input type="checkbox"/>	+\$0
HM	natural maple <input type="checkbox"/>	+\$0
HP	light anigre <input type="checkbox"/>	+\$0
HX	aged cherry <input type="checkbox"/>	+\$0
HY	walnut on cherry <input type="checkbox"/>	+\$0
LA	light ash <input type="checkbox"/>	+\$0
LBA	clear on ash <input type="checkbox"/>	+\$0
LBR	phantom ecru <input type="checkbox"/>	+\$0
LBS	phantom cocoa <input type="checkbox"/>	+\$0
LBU	medium matte walnut <input type="checkbox"/>	+\$0
LBV	warm grey teak <input type="checkbox"/>	+\$0
LBW	oak on ash <input type="checkbox"/>	+\$0
LBC	walnut on ash <input type="checkbox"/>	+\$0
LBD	dark brown walnut <input type="checkbox"/>	+\$0
LBE	medium red walnut <input type="checkbox"/>	+\$0
LBF	neutral twill <input type="checkbox"/>	+\$0
LBG	sarum twill <input type="checkbox"/>	+\$0
LBH	earthen twill <input type="checkbox"/>	+\$0
LBJ	graphite twill <input type="checkbox"/>	+\$0
LBK	pewter mesh <input type="checkbox"/>	+\$0
LBL	steel mesh <input type="checkbox"/>	+\$0
LBM	crisp linen <input type="checkbox"/>	+\$0
LBN	classic linen <input type="checkbox"/>	+\$0
LBP	casual linen <input type="checkbox"/>	+\$0
LBQ	white twill <input type="checkbox"/>	+\$0
LU	soft white <input type="checkbox"/>	+\$0
WL	sandstone <input type="checkbox"/>	+\$0
WN	warm grey neutral <input type="checkbox"/>	+\$0

For 3/8" veneer thin top (4)

2U	light brown walnut <input type="checkbox"/>	+\$85
40	dark brown walnut <input type="checkbox"/>	+\$85
ED	aged cherry <input type="checkbox"/>	+\$85
EK	medium red walnut <input type="checkbox"/>	+\$85
EW	medium matte walnut <input type="checkbox"/>	+\$85
ET	clear on ash <input type="checkbox"/>	+\$85
EU	oak on ash <input type="checkbox"/>	+\$85
EV	walnut on ash <input type="checkbox"/>	+\$85
UL	natural maple <input type="checkbox"/>	+\$85
UX	walnut on cherry <input type="checkbox"/>	+\$85

Bookcase Hutch, Storage

Attached *continued*

Canvas Office Landscape® Attaching Storage

Step 14. Lock Option		
For lock (L)		
KA	keyed alike <input type="checkbox"/>	-\$10
KC	keyed differently, chrome <input type="checkbox"/>	+\$0
KD	keyed differently, black <input type="checkbox"/>	+\$0

Wardrobe Hutch, Storage Attached

FV455.

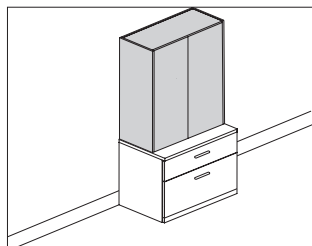

Product Information

Description

This fully enclosed wardrobe hutch attaches to a wood low credenza with 1/4" top. Top options are a finished case top or 3/8" laminate or veneer thin top. Wardrobe hutch doors have touch latches and optional locks. Attachment hardware included.

Notes

Enclosed hutch with finished case top aligns with top of bead on a frame attached tile. Adding a thin top increases overall height 1/2".

Align like components next to like units: Finished case units with other finished case units, thin top units with other thin top units.

Hutch 15 5/8" wide (16) attaches to a wood box/file pedestal; 24"-wide (24) or 30"-wide (30) hutch attaches to Canvas wood low credenza with 1/4" top.

Hutch width must match width of lower storage.

Hutch matches style of wood overhead storage in FV43 series.

Actual case widths are 15 5/8" (16), 23 7/8" (24), and 29 7/8" (30).

Actual case depths are 14 7/8" (15) and 19 7/8" (20).

- 15" deep (15) matches depth of overhead storage in FV43 series.

- 20" deep (20) matches depth of Canvas low storage.

Wardrobe has 1 fixed-height shelf with attached coat hook or coat rod.

- 15" deep (15) units have a coat hook; 20" deep (20) units have a coat rod.

- 15 5/8" wide (16) and 24" wide (24) units have 1 coat hook; 30" wide (30) units have 2 coat hooks.

Hutch case is available in laminate or veneer; doors in laminate, veneer, or back-painted glass; 3/8" thin top in laminate or veneer.

15 5/8"-wide (16) and 24"-wide (24) units have single door; 30"-wide (30) units have symmetrical doors.

Glass doors are back-painted and writable with dry-erase marker. Glass doors cannot lock.

Grain direction is vertical on veneer, wood-grain, and patterned laminate case and fronts.

Dimensional illustration does not include all possible configurations.

For keyed-alike locks, see Keyed-Alike Information in appendices.

Dimensions

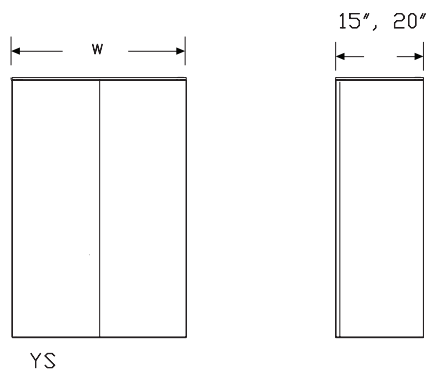
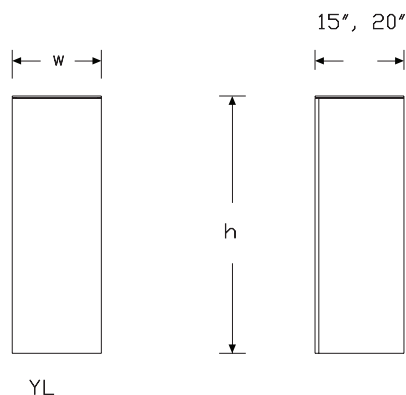

Wardrobe Hutch, Storage

Attached *continued*

Specification Information

Step 1.

FV455. [A]

Step 2. Base Attachment

LC2 low credenza, 2 1/4"-high base with 1 1/4" top [A] +\$150
LC4 low credenza, 4"-high foot with 1 1/4" top [A] +\$150

Step 3. Datum Height

7 68" high [A] +\$600

Step 4. Width

16 15 5/8" wide [A] +\$450
24 24" wide [A] +\$500
30 30" wide [A] +\$550

Step 5. Depth

15 15" deep [A] +\$200
20 20" deep [A] +\$250

Step 6. Configuration

For 15 5/8" wide (16) or 24" wide (24)

YL wardrobe only, left-hinged door [A] +\$0
YR wardrobe only, right-hinged door [A] +\$0

For 30" wide (30)

YS wardrobe only, two symmetrical doors [A] +\$0

Step 7. Wardrobe Interior

For 15" deep (15)

K coat hook under fixed height shelf [A] +\$100

For 20" deep (20)

C coat rod under fixed height shelf [A] +\$200
K coat hook under fixed height shelf [A] +\$100

Step 8. Case/Door Material

For 15 5/8" wide (16)

L laminate case and door [A] +\$333
C laminate case/veneer door [A] +\$878
W veneer case and door [A] +\$1244
G laminate case/glass door [A] +\$921
R veneer case/glass door [A] +\$1286

For 24" wide (24)

L laminate case and door [A] +\$495
C laminate case/veneer door [A] +\$1586
W veneer case and door [A] +\$2242
G laminate case/glass door [A] +\$1761
R veneer case/glass door [A] +\$2416

For 30" wide (30)

L laminate case and door [A] +\$657
C laminate case/veneer door [A] +\$1958
W veneer case and door [A] +\$2814
G laminate case/glass door [A] +\$2111
R veneer case/glass door [A] +\$2967

Step 9. Top

T finished case top [A] +\$0
3 3/8" laminate thin top [A] +\$150
4 3/8" veneer thin top [A] +\$300

Step 10. Lock

For laminate case and door (L), laminate case/veneer door (C), or veneer case and door (W)

L lock [A] +\$0
N no lock [A] +\$0

For laminate case/glass door (G) or veneer case/glass door (R)

N no lock [A] +\$0

Wardrobe Hutch, Storage

Attached *continued*

Step 11. Case/Edge Finish

For laminate case and door (L), laminate case/veneer door (C), or laminate case/glass door (G)

76	light brown walnut <input type="checkbox"/>	+\$0
8Q	folkstone grey <input type="checkbox"/>	+\$0
91	white <input type="checkbox"/>	+\$0
98	studio white <input type="checkbox"/>	+\$0
CL	cool grey neutral <input type="checkbox"/>	+\$0
HM	natural maple <input type="checkbox"/>	+\$0
HP	light anigre <input type="checkbox"/>	+\$0
HX	aged cherry <input type="checkbox"/>	+\$0
HY	walnut on cherry <input type="checkbox"/>	+\$0
LA	light ash <input type="checkbox"/>	+\$0
LBA	clear on ash <input type="checkbox"/>	+\$0
LBR	phantom ecru <input type="checkbox"/>	+\$0
LBS	phantom cocoa <input type="checkbox"/>	+\$0
LBU	medium matte walnut <input type="checkbox"/>	+\$0
LBV	warm grey teak <input type="checkbox"/>	+\$0
LBB	oak on ash <input type="checkbox"/>	+\$0
LBC	walnut on ash <input type="checkbox"/>	+\$0
LBD	dark brown walnut <input type="checkbox"/>	+\$0
LBE	medium red walnut <input type="checkbox"/>	+\$0
LBF	neutral twill <input type="checkbox"/>	+\$0
LBG	sarum twill <input type="checkbox"/>	+\$0
LBH	earthen twill <input type="checkbox"/>	+\$0
LBJ	graphite twill <input type="checkbox"/>	+\$0
LBK	pewter mesh <input type="checkbox"/>	+\$0
LBL	steel mesh <input type="checkbox"/>	+\$0
LBM	crisp linen <input type="checkbox"/>	+\$0
LBN	classic linen <input type="checkbox"/>	+\$0
LBP	casual linen <input type="checkbox"/>	+\$0
LBQ	white twill <input type="checkbox"/>	+\$0
LU	soft white <input type="checkbox"/>	+\$0
WL	sandstone <input type="checkbox"/>	+\$0
WN	warm grey neutral <input type="checkbox"/>	+\$0

For veneer case and door (W) or veneer case/glass door (R)

2U	light brown walnut <input type="checkbox"/>	+\$0
40	dark brown walnut <input type="checkbox"/>	+\$0
ED	aged cherry <input type="checkbox"/>	+\$0
EK	medium red walnut <input type="checkbox"/>	+\$0
EW	medium matte walnut <input type="checkbox"/>	+\$0
ET	clear on ash <input type="checkbox"/>	+\$0
EU	oak on ash <input type="checkbox"/>	+\$0
EV	walnut on ash <input type="checkbox"/>	+\$0
UL	natural maple <input type="checkbox"/>	+\$0
UX	walnut on cherry <input type="checkbox"/>	+\$0

Step 12. Door/Edge Finish

For laminate case and door (L)

76	light brown walnut <input type="checkbox"/>	+\$0
8Q	folkstone grey <input type="checkbox"/>	+\$0
91	white <input type="checkbox"/>	+\$0
98	studio white <input type="checkbox"/>	+\$0
CL	cool grey neutral <input type="checkbox"/>	+\$0
HM	natural maple <input type="checkbox"/>	+\$0
HP	light anigre <input type="checkbox"/>	+\$0
HX	aged cherry <input type="checkbox"/>	+\$0
HY	walnut on cherry <input type="checkbox"/>	+\$0
LA	light ash <input type="checkbox"/>	+\$0
LBA	clear on ash <input type="checkbox"/>	+\$0
LBB	oak on ash <input type="checkbox"/>	+\$0
LBC	walnut on ash <input type="checkbox"/>	+\$0
LBD	dark brown walnut <input type="checkbox"/>	+\$0
LBE	medium red walnut <input type="checkbox"/>	+\$0
LBF	neutral twill <input type="checkbox"/>	+\$0
LBG	sarum twill <input type="checkbox"/>	+\$0
LBH	earthen twill <input type="checkbox"/>	+\$0
LBJ	graphite twill <input type="checkbox"/>	+\$0
LBK	pewter mesh <input type="checkbox"/>	+\$0
LBL	steel mesh <input type="checkbox"/>	+\$0
LBM	crisp linen <input type="checkbox"/>	+\$0
LBN	classic linen <input type="checkbox"/>	+\$0
LBP	casual linen <input type="checkbox"/>	+\$0
LBQ	white twill <input type="checkbox"/>	+\$0
LBR	phantom ecru <input type="checkbox"/>	+\$0
LBS	phantom cocoa <input type="checkbox"/>	+\$0
LBU	medium matte walnut <input type="checkbox"/>	+\$0
LBV	warm grey teak <input type="checkbox"/>	+\$0
LU	soft white <input type="checkbox"/>	+\$0
WL	sandstone <input type="checkbox"/>	+\$0
WN	warm grey neutral <input type="checkbox"/>	+\$0

Wardrobe Hutch, Storage Attached *continued*

Canvas Office Landscape® Attaching Storage

For laminate case/veneer door (C) or veneer case and door (W)

2U	light brown walnut <input type="checkbox"/>	+\$0
40	dark brown walnut <input type="checkbox"/>	+\$0
ED	aged cherry <input type="checkbox"/>	+\$0
EK	medium red walnut <input type="checkbox"/>	+\$0
EW	medium matte walnut <input type="checkbox"/>	+\$0
ET	clear on ash <input type="checkbox"/>	+\$0
EU	oak on ash <input type="checkbox"/>	+\$0
EV	walnut on ash <input type="checkbox"/>	+\$0
UL	natural maple <input type="checkbox"/>	+\$0
UX	walnut on cherry <input type="checkbox"/>	+\$0

For laminate case/glass door (G) or veneer case/glass door (R)

8Q	folkstone grey <input type="checkbox"/>	+\$0
91	white <input type="checkbox"/>	+\$0
98	studio white <input type="checkbox"/>	+\$0

Step 13. Top/Edge Finish

For ³/₈" laminate thin top (3)

76	light brown walnut <input type="checkbox"/>	+\$0
8Q	folkstone grey <input type="checkbox"/>	+\$0
91	white <input type="checkbox"/>	+\$0
98	studio white <input type="checkbox"/>	+\$0
CL	cool grey neutral <input type="checkbox"/>	+\$0
HM	natural maple <input type="checkbox"/>	+\$0
HP	light anigre <input type="checkbox"/>	+\$0
HX	aged cherry <input type="checkbox"/>	+\$0
HY	walnut on cherry <input type="checkbox"/>	+\$0
LA	light ash <input type="checkbox"/>	+\$0
LBA	clear on ash <input type="checkbox"/>	+\$0
LBR	phantom ecru <input type="checkbox"/>	+\$0
LBS	phantom cocoa <input type="checkbox"/>	+\$0
LBU	medium matte walnut <input type="checkbox"/>	+\$0
LBV	warm grey teak <input type="checkbox"/>	+\$0
LBB	oak on ash <input type="checkbox"/>	+\$0
LBC	walnut on ash <input type="checkbox"/>	+\$0
LBD	dark brown walnut <input type="checkbox"/>	+\$0
LBE	medium red walnut <input type="checkbox"/>	+\$0
LBF	neutral twill <input type="checkbox"/>	+\$0
LBG	sarum twill <input type="checkbox"/>	+\$0
LBH	earthen twill <input type="checkbox"/>	+\$0
LBJ	graphite twill <input type="checkbox"/>	+\$0
LBK	pewter mesh <input type="checkbox"/>	+\$0
LBL	steel mesh <input type="checkbox"/>	+\$0
LBM	crisp linen <input type="checkbox"/>	+\$0
LBN	classic linen <input type="checkbox"/>	+\$0
LBP	casual linen <input type="checkbox"/>	+\$0
LBQ	white twill <input type="checkbox"/>	+\$0
LU	soft white <input type="checkbox"/>	+\$0
WL	sandstone <input type="checkbox"/>	+\$0
WN	warm grey neutral <input type="checkbox"/>	+\$0

For ³/₈" veneer thin top (4)

2U	light brown walnut <input type="checkbox"/>	+\$85
40	dark brown walnut <input type="checkbox"/>	+\$85
ED	aged cherry <input type="checkbox"/>	+\$85
EK	medium red walnut <input type="checkbox"/>	+\$85
EW	medium matte walnut <input type="checkbox"/>	+\$85
ET	clear on ash <input type="checkbox"/>	+\$85
EU	oak on ash <input type="checkbox"/>	+\$85
EV	walnut on ash <input type="checkbox"/>	+\$85
UL	natural maple <input type="checkbox"/>	+\$85
UX	walnut on cherry <input type="checkbox"/>	+\$85

Wardrobe Hutch, Storage Attached *continued*

Step 14. Lock Option

For lock (L)

KA	keyed alike <input type="checkbox"/>	-\$10
KC	keyed differently, chrome <input type="checkbox"/>	+\$0
KD	keyed differently, black <input type="checkbox"/>	+\$0

Hutch, Partial Enclosure, Storage Attached FV456.

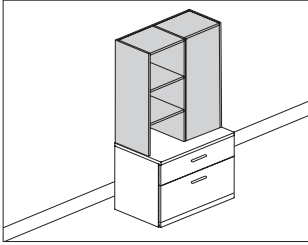

Canvas Office Landscape® Attaching Storage

Product Information

Description

This hutch attaches to a wood low or high credenza with 1 1/4" top and has the option of a door on one side with exposed shelves on the other side. Top options are a finished case top or 3/8" laminate or veneer thin top. Hutch doors have touch latches and optional locks. Attachment hardware included.

Notes

Partially enclosed hutch with finished case top aligns with top of bead on a frame attached tile. Adding a thin top increases overall height 1/2". Align like components next to like units: Finished case units with other finished case units, thin top units with other thin top units.

Hutch attaches to matching-width Canvas wood lateral files, wood low credenzas, and wood high credenzas with 1 1/4" top.

Hutch matches style of wood overhead storage in FV43 series.

Actual case widths are 29 7/8" (30), 35 7/8" (36), or 41 7/8" (42).

Actual case depths are 14 7/8" (15) and 19 7/8" (20).

- 15" deep (15) matches depth of overhead storage in FV43 series.

- 20" deep (20) matches depth of Canvas low storage.

15" deep (15) units have a coat hook; 20" deep (20) units have a coat rod in the wardrobe.

Storage compartment has 1 or more adjustable shelves that adjust in 1 1/4" increments.

Hutch case is available in laminate or veneer; door in laminate, veneer, or back-painted glass; 3/8" thin top in laminate or veneer.

Symmetric units have 3 nominal door widths: 15", 18", and 21".

Asymmetric units have 3 nominal door widths: 10", 12", and 15".

Glass doors are back-painted and writable with dry-erase marker. Glass doors cannot lock.

Grain direction is vertical on veneer, wood-grain, and patterned laminate case and fronts.

Dimensional illustration does not include all possible configurations.

For keyed-alike locks, see Keyed-Alike Information in appendices.

Dimensions

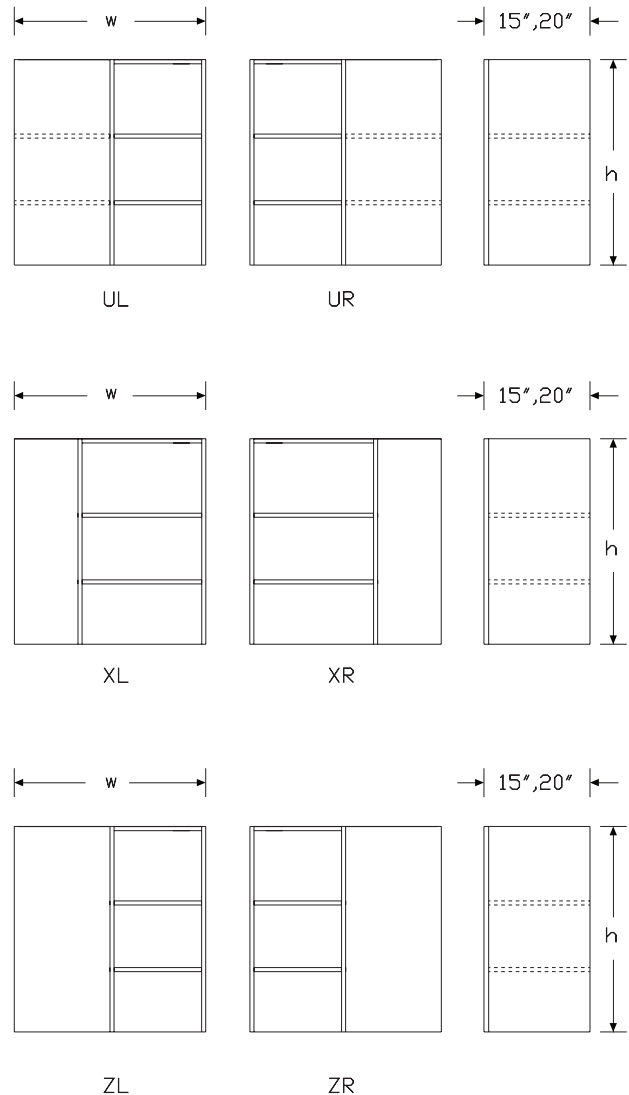

Hutch, Partial Enclosure, Storage Attached *continued*

Specification Information

Step 1.

FV456. A

Step 2. Base Attachment

LC2	low credenza, 2 ¹ / ₄ "-high base with 1 ¹ / ₄ " top A	+\$150
LC4	low credenza, 4"-high foot with 1 ¹ / ₄ " top A	+\$150
HC2	high credenza, 2 ¹ / ₄ "-high base with 1 ¹ / ₄ " top A	+\$0

Step 3. Datum Height

6	57" high A	+\$450
7	68" high A	+\$600

Step 4. Width

30	30" wide A	+\$550
36	36" wide A	+\$650
42	42" wide A	+\$850

Step 5. Depth

15	15" deep A	+\$200
20	20" deep A	+\$250

Step 6. Configuration

For low credenza, 2¹/₄"-high base with 1¹/₄" top (LC2) or low credenza, 4"-high foot with 1¹/₄" top (LC4) with 57" high (6)

UL	symmetric shelves left hinged door, open shelves right A	+\$0
UR	open shelves left, symmetric shelves right hinged door A	+\$0

For low credenza, 2¹/₄"-high base with 1¹/₄" top (LC2) or low credenza, 4"-high foot with 1¹/₄" top (LC4) with 68" high (7)

UL	symmetric shelves left hinged door, open shelves right A	+\$0
UR	open shelves left, symmetric shelves right hinged door A	+\$0
XL	asymmetric wardrobe left hinged door, open shelves right A	+\$0
XR	open shelves left, asymmetric wardrobe right hinged door A	+\$0
ZL	symmetric wardrobe left hinged door, open shelves right A	+\$0
ZR	open shelves left, symmetric wardrobe right hinged door A	+\$0

For high credenza, 2¹/₄"-high base with 1¹/₄" top (HC2) with 57" high (6) or 68" high (7)

UL	symmetric shelves left hinged door, open shelves right A	+\$0
UR	open shelves left, symmetric shelves right hinged door A	+\$0

Step 7. Case/Door Material

For 30" wide (30)

L	laminate case and door A	+\$377
C	laminate case/veneer door A	+\$1542
W	veneer case and door A	+\$2759
G	laminate case/glass door A	+\$723
R	veneer case/glass door A	+\$1940

For 36" wide (36)

L	laminate case and door A	+\$504
C	laminate case/veneer door A	+\$1861
W	veneer case and door A	+\$3354
G	laminate case/glass door A	+\$871
R	veneer case/glass door A	+\$2365

For 42" wide (42)

L	laminate case and door A	+\$594
C	laminate case/veneer door A	+\$2315
W	veneer case and door A	+\$4085
G	laminate case/glass door A	+\$1000
R	veneer case/glass door A	+\$2770

Step 8. Top

T	finished case top A	+\$0
3	³ / ₈ " laminate thin top A	+\$150
4	³ / ₈ " veneer thin top A	+\$300

Step 9. Lock

For laminate case and door (L), laminate case/veneer door (C), or veneer case and door (W)

L	lock A	+\$0
N	no lock A	+\$0

For laminate case/glass door (G) or veneer case/glass door (R)

N	no lock A	+\$0
----------	---	------

Hutch, Partial Enclosure, Storage Attached *continued*

Step 10. Case/Edge Finish

For laminate case and door (L), laminate case/veneer door (C), or laminate case/glass door (G)

76	light brown walnut <input type="checkbox"/>	+\$0
8Q	folkstone grey <input type="checkbox"/>	+\$0
91	white <input type="checkbox"/>	+\$0
98	studio white <input type="checkbox"/>	+\$0
CL	cool grey neutral <input type="checkbox"/>	+\$0
HM	natural maple <input type="checkbox"/>	+\$0
HP	light anigre <input type="checkbox"/>	+\$0
HX	aged cherry <input type="checkbox"/>	+\$0
HY	walnut on cherry <input type="checkbox"/>	+\$0
LA	light ash <input type="checkbox"/>	+\$0
LBA	clear on ash <input type="checkbox"/>	+\$0
LBR	phantom ecru <input type="checkbox"/>	+\$0
LBS	phantom cocoa <input type="checkbox"/>	+\$0
LBU	medium matte walnut <input type="checkbox"/>	+\$0
LBV	warm grey teak <input type="checkbox"/>	+\$0
LBB	oak on ash <input type="checkbox"/>	+\$0
LBC	walnut on ash <input type="checkbox"/>	+\$0
LBD	dark brown walnut <input type="checkbox"/>	+\$0
LBE	medium red walnut <input type="checkbox"/>	+\$0
LBF	neutral twill <input type="checkbox"/>	+\$0
LBG	sarum twill <input type="checkbox"/>	+\$0
LBH	earthen twill <input type="checkbox"/>	+\$0
LBJ	graphite twill <input type="checkbox"/>	+\$0
LBK	pewter mesh <input type="checkbox"/>	+\$0
LBL	steel mesh <input type="checkbox"/>	+\$0
LBM	crisp linen <input type="checkbox"/>	+\$0
LBN	classic linen <input type="checkbox"/>	+\$0
LBP	casual linen <input type="checkbox"/>	+\$0
LBQ	white twill <input type="checkbox"/>	+\$0
LU	soft white <input type="checkbox"/>	+\$0
WL	sandstone <input type="checkbox"/>	+\$0
WN	warm grey neutral <input type="checkbox"/>	+\$0

For veneer case and door (W) or veneer case/glass door (R)

2U	light brown walnut <input type="checkbox"/>	+\$0
40	dark brown walnut <input type="checkbox"/>	+\$0
ED	aged cherry <input type="checkbox"/>	+\$0
EK	medium red walnut <input type="checkbox"/>	+\$0
EW	medium matte walnut <input type="checkbox"/>	+\$0
ET	clear on ash <input type="checkbox"/>	+\$0
EU	oak on ash <input type="checkbox"/>	+\$0
EV	walnut on ash <input type="checkbox"/>	+\$0
UL	natural maple <input type="checkbox"/>	+\$0
UX	walnut on cherry <input type="checkbox"/>	+\$0

Step 11. Door/Edge Finish

For laminate case and door (L)

76	light brown walnut <input type="checkbox"/>	+\$0
8Q	folkstone grey <input type="checkbox"/>	+\$0
91	white <input type="checkbox"/>	+\$0
98	studio white <input type="checkbox"/>	+\$0
CL	cool grey neutral <input type="checkbox"/>	+\$0
HM	natural maple <input type="checkbox"/>	+\$0
HP	light anigre <input type="checkbox"/>	+\$0
HX	aged cherry <input type="checkbox"/>	+\$0
HY	walnut on cherry <input type="checkbox"/>	+\$0
LA	light ash <input type="checkbox"/>	+\$0
LBA	clear on ash <input type="checkbox"/>	+\$0
LBB	oak on ash <input type="checkbox"/>	+\$0
LBC	walnut on ash <input type="checkbox"/>	+\$0
LBD	dark brown walnut <input type="checkbox"/>	+\$0
LBE	medium red walnut <input type="checkbox"/>	+\$0
LBF	neutral twill <input type="checkbox"/>	+\$0
LBG	sarum twill <input type="checkbox"/>	+\$0
LBH	earthen twill <input type="checkbox"/>	+\$0
LBJ	graphite twill <input type="checkbox"/>	+\$0
LBK	pewter mesh <input type="checkbox"/>	+\$0
LBL	steel mesh <input type="checkbox"/>	+\$0
LBM	crisp linen <input type="checkbox"/>	+\$0
LBN	classic linen <input type="checkbox"/>	+\$0
LBP	casual linen <input type="checkbox"/>	+\$0
LBQ	white twill <input type="checkbox"/>	+\$0
LBR	phantom ecru <input type="checkbox"/>	+\$0
LBS	phantom cocoa <input type="checkbox"/>	+\$0
LBU	medium matte walnut <input type="checkbox"/>	+\$0
LBV	warm grey teak <input type="checkbox"/>	+\$0
LU	soft white <input type="checkbox"/>	+\$0
WL	sandstone <input type="checkbox"/>	+\$0
WN	warm grey neutral <input type="checkbox"/>	+\$0

Hutch, Partial Enclosure, Storage Attached *continued*

For laminate case/veneer door (C) or veneer case and door (W)

2U	light brown walnut <input type="checkbox"/>	+\$0
40	dark brown walnut <input type="checkbox"/>	+\$0
ED	aged cherry <input type="checkbox"/>	+\$0
EK	medium red walnut <input type="checkbox"/>	+\$0
EW	medium matte walnut <input type="checkbox"/>	+\$0
ET	clear on ash <input type="checkbox"/>	+\$0
EU	oak on ash <input type="checkbox"/>	+\$0
EV	walnut on ash <input type="checkbox"/>	+\$0
UL	natural maple <input type="checkbox"/>	+\$0
UX	walnut on cherry <input type="checkbox"/>	+\$0

For laminate case/glass door (G) or veneer case/glass door (R)

8Q	folkstone grey <input type="checkbox"/>	+\$0
91	white <input type="checkbox"/>	+\$0
98	studio white <input type="checkbox"/>	+\$0

Step 12. Top/Edge Finish

For 3/8" laminate thin top (3)

76	light brown walnut <input type="checkbox"/>	+\$0
8Q	folkstone grey <input type="checkbox"/>	+\$0
91	white <input type="checkbox"/>	+\$0
98	studio white <input type="checkbox"/>	+\$0
CL	cool grey neutral <input type="checkbox"/>	+\$0
HM	natural maple <input type="checkbox"/>	+\$0
HP	light anigre <input type="checkbox"/>	+\$0
HX	aged cherry <input type="checkbox"/>	+\$0
HY	walnut on cherry <input type="checkbox"/>	+\$0
LA	light ash <input type="checkbox"/>	+\$0
LBA	clear on ash <input type="checkbox"/>	+\$0
LBR	phantom ecru <input type="checkbox"/>	+\$0
LBS	phantom cocoa <input type="checkbox"/>	+\$0
LBU	medium matte walnut <input type="checkbox"/>	+\$0
LBV	warm grey teak <input type="checkbox"/>	+\$0
LBW	oak on ash <input type="checkbox"/>	+\$0
LBC	walnut on ash <input type="checkbox"/>	+\$0
LBD	dark brown walnut <input type="checkbox"/>	+\$0
LBE	medium red walnut <input type="checkbox"/>	+\$0
LBF	neutral twill <input type="checkbox"/>	+\$0
LBG	sarum twill <input type="checkbox"/>	+\$0
LBH	earthen twill <input type="checkbox"/>	+\$0
LBJ	graphite twill <input type="checkbox"/>	+\$0
LBK	pewter mesh <input type="checkbox"/>	+\$0
LBL	steel mesh <input type="checkbox"/>	+\$0
LBM	crisp linen <input type="checkbox"/>	+\$0
LBN	classic linen <input type="checkbox"/>	+\$0
LBP	casual linen <input type="checkbox"/>	+\$0
LBQ	white twill <input type="checkbox"/>	+\$0
LU	soft white <input type="checkbox"/>	+\$0
WL	sandstone <input type="checkbox"/>	+\$0
WN	warm grey neutral <input type="checkbox"/>	+\$0

For 3/8" veneer thin top (4)

2U	light brown walnut <input type="checkbox"/>	+\$0
40	dark brown walnut <input type="checkbox"/>	+\$0
ED	aged cherry <input type="checkbox"/>	+\$0
EK	medium red walnut <input type="checkbox"/>	+\$0
EW	medium matte walnut <input type="checkbox"/>	+\$0
ET	clear on ash <input type="checkbox"/>	+\$0
EU	oak on ash <input type="checkbox"/>	+\$0
EV	walnut on ash <input type="checkbox"/>	+\$0
UL	natural maple <input type="checkbox"/>	+\$0
UX	walnut on cherry <input type="checkbox"/>	+\$0

Hutch, Partial Enclosure, Storage
Attached *continued*

Canvas Office Landscape® Attaching Storage

Step 13. Lock Option		
<i>For lock (L)</i>		
KA	keyed alike <input type="checkbox"/> A	-\$10
KC	keyed differently, chrome <input type="checkbox"/> A	+\$0
KD	keyed differently, black <input type="checkbox"/> A	+\$0

Hutch, Partial Enclosure

FV450.

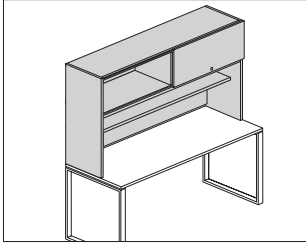

Product Information

Description

This hutch attaches onto a surface to provide partially enclosed overhead storage. It is available in 2 heights; the 29"-high has a storage area with a sliding door, the 40"-high has a storage area with sliding door and a shelf below. The sliding door with optional lock encloses 1 side of the storage area and can be locked on either side. The back panel is raised $1\frac{3}{8}$ " above the surface to provide routing of cords and cables. The underside of hutch accepts a task light.

Notes

For additional product options, see Vary Easy Program in Appendices.

Installation requires field drilling through top of surface.

Grain direction is vertical on veneer and wood-grain laminate hutch door.

59"- and 60"-wide hutches have 1 door. 65"-, 66"-, 71"- and 72"-wide hutches have 2 doors.

59"- and 60"-wide hutches have a center divider. 65"- and 66"-wide have 2 dividers and are divided as $\frac{1}{3}$, $\frac{1}{3}$, $\frac{1}{3}$. 71"-, and 72"-wide hutches have 2 dividers and are divided as $\frac{1}{4}$, $\frac{1}{2}$, $\frac{1}{4}$.

When attaching hutch to a rectangular surface or return, specify hutch width to match surface width. When attaching hutch to an extended corner surface or a corner application with a rectangular surface and return, specify hutch width 1" less than overall width.

Order optional task lights and accessories separately:

- Cord manager (FV984.)
- Performance task light (G6114.xxxxT)
- Utility task light (G6136.xxT)

For keyed-alike locks, see Keyed-Alike Information in Appendices.

Dimensions

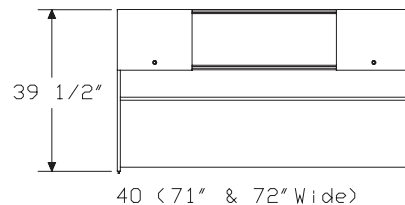
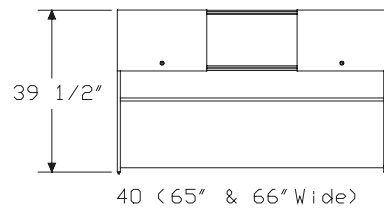
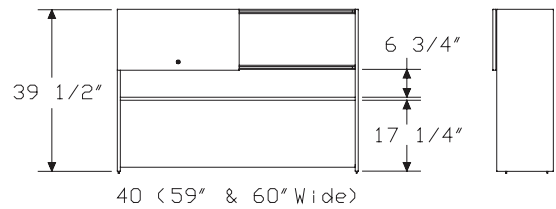
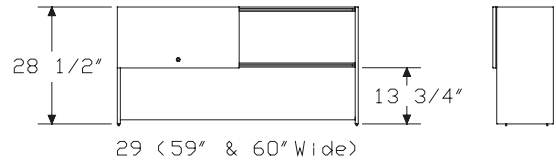
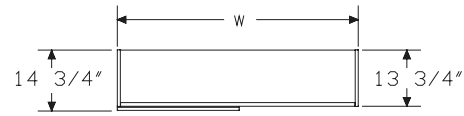

Hutch, Partial Enclosure *continued*

Canvas Office Landscape® Attaching Storage (Legacy Products)

Specification Information

Step 1.

FV450.

Step 2. Height

29	28½" high
40	39½" high

Step 3. Width

59	59" wide
60	60" wide
65	65" wide
66	66" wide
71	71" wide
72	72" wide

Step 4. Case/Door Material

L	laminate
C	laminate case/veneer door A
W	veneer A

Step 5. Lock

N	no lock
L	lock

Prices for Steps 1-5.

		LN	LL	CN	CL	WN	WL
FV450. 29	59	\$1660	1672	1933	1944	3286	3296
	60	\$1660	1672	1933	1944	3286	3296
	65	\$1777	1788	2059	2072	3499	3510
	66	\$1777	1788	2059	2072	3499	3510
	71	\$1893	1914	2186	2208	3714	3736
	72	\$1893	1914	2186	2208	3714	3736
40	59	\$1860	1870	2165	2175	3678	3690
	60	\$1860	1870	2165	2175	3678	3690
	65	\$1989	2000	2306	2317	3919	3930
	66	\$1989	2000	2306	2317	3919	3930
	71	\$2119	2142	2449	2469	4159	4182
	72	\$2119	2142	2449	2469	4159	4182

Step 6. Lock Option

For lock (L)

KA	keyed alike	-\$10
KC	keyed differently, chrome	+\$0

Step 7. Case/Stanchion Finish

Solid-Color Laminate

For 59" wide (59), 60" wide (60), 65" wide (65), 66" wide (66), 71" wide (71), or 72" wide (72) with laminate (L), or laminate case/veneer door (C)

8Q	folkstone grey	+\$0
91	white	+\$0
98	studio white	+\$0
CL	cool grey neutral	+\$0
LU	soft white	+\$0
WL	sandstone	+\$0
WN	warm grey neutral	+\$0

Linen Laminate

For 59" wide (59) or 60" wide (60) with laminate (L), or laminate case/veneer door (C)

LBM	crisp linen	+\$0
LBN	classic linen	+\$0
LBP	casual linen	+\$0

Mesh Laminate

For 59" wide (59) or 60" wide (60) with laminate (L), or laminate case/veneer door (C)

LBK	pewter mesh	+\$0
LBL	steel mesh	+\$0

Twill Laminate

For 59" wide (59) or 60" wide (60) with laminate (L), or laminate case/veneer door (C)

LBF	neutral twill	+\$0
LBG	sarum twill	+\$0
LBH	earthen twill	+\$0
LBJ	graphite twill	+\$0
LBQ	white twill	+\$0

Hutch, Partial Enclosure *continued*

Wood-Grain Laminate

For 59" wide (59) or 60" wide (60) with laminate (L), or laminate case/
veneer door (C)

HM	natural maple	+\$0
HP	light anigre	+\$0
LBA	clear on ash	+\$0
LBR	phantom ecru	+\$0
LBS	phantom cocoa	+\$0
LBU	medium matte walnut	+\$0
LBV	warm grey teak	+\$0
LBB	oak on ash	+\$0
LBC	walnut on ash	+\$0
LBD	dark brown walnut	+\$0
LBE	medium red walnut	+\$0
76	light brown walnut	+\$0
HX	aged cherry	+\$0
HY	walnut on cherry	+\$0

Wood Veneer

For veneer (W)

2U	light brown walnut A	+\$0
40	dark brown walnut	+\$0
ED	aged cherry A	+\$0
EK	medium red walnut	+\$0
EW	medium matte walnut	+\$0
ET	clear on ash A	+\$0
EU	oak on ash A	+\$0
EV	walnut on ash A	+\$0
UL	natural maple A	+\$0
UX	walnut on cherry	+\$0

Step 8. Door Finish

Solid-Color Laminate

For laminate (L)

8Q	folkstone grey	+\$0
91	white	+\$0
98	studio white	+\$0
CL	cool grey neutral	+\$0
LU	soft white	+\$0
WL	sandstone	+\$0
WN	warm grey neutral	+\$0

Linen Laminate

For laminate (L)

LBM	crisp linen	+\$0
LBN	classic linen	+\$0
LBP	casual linen	+\$0

Mesh Laminate

For laminate (L)

LBK	pewter mesh	+\$0
LBL	steel mesh	+\$0

Twill Laminate

For laminate (L)

LBF	neutral twill	+\$0
LBG	sarum twill	+\$0
LBH	earthen twill	+\$0
LBJ	graphite twill	+\$0
LBQ	white twill	+\$0

Wood-Grain Laminate

For laminate (L)

HM	natural maple	+\$0
HP	light anigre	+\$0
LBA	clear on ash	+\$0
LBR	phantom ecru	+\$0
LBS	phantom cocoa	+\$0
LBU	medium matte walnut	+\$0
LBV	warm grey teak	+\$0
LBB	oak on ash	+\$0
LBC	walnut on ash	+\$0
LBD	dark brown walnut	+\$0
LBE	medium red walnut	+\$0
76	light brown walnut	+\$0
HX	aged cherry	+\$0
HY	walnut on cherry	+\$0

Hutch, Partial Enclosure *continued*

Wood Veneer

For laminate case/veneer door (C) or veneer (W)

2U	light brown walnut <input type="checkbox"/> A	+\$0
40	dark brown walnut	+\$0
ED	aged cherry <input type="checkbox"/> A	+\$0
EK	medium red walnut	+\$0
EW	medium matte walnut	+\$0
ET	clear on ash <input type="checkbox"/> A	+\$0
EU	oak on ash <input type="checkbox"/> A	+\$0
EV	walnut on ash <input type="checkbox"/> A	+\$0
UL	natural maple <input type="checkbox"/> A	+\$0
UX	walnut on cherry	+\$0

Hutch, Full Enclosure

FV451.

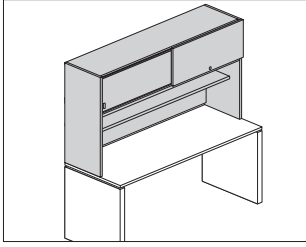

Product Information

Description

This hutch attaches onto a surface to provide fully enclosed overhead storage. It is available in 2 heights; the 29"-high has a storage area with sliding doors, the 40"-high has a storage area with sliding doors and a shelf below. It has 2 types of sliding doors; a solid primary door with an optional lock encloses 1 side, and a painted or translucent secondary door encloses the other side. Both doors can slide the entire width of the hutch. The primary door can be locked on either side. Secondary door handle finish is anodized aluminum. The underside of hutch accepts a task light.

Notes

For additional product options, see Vary Easy Program in Appendices.

Installation requires field drilling through top of surface.

Grain direction is vertical on veneer and wood-grain laminate hutch door.

59"- and 60"-wide hutches have 1 primary and 1 secondary door. 65"- and 66"-wide hutches have 2 primary doors and 1 secondary door. 71"- and 72"-wide hutches have 2 primary and 2 secondary doors. Primary doors lock at the ends of the hutch only.

59"- and 60"-wide hutches have a center divider. 65"- and 66"-wide have 2 dividers and are divided as $\frac{1}{3}$, $\frac{1}{3}$, $\frac{1}{3}$. 71"- and 72"-wide hutches have 2 dividers and are divided as $\frac{1}{4}$, $\frac{1}{2}$, $\frac{1}{4}$.

When attaching hutch to a rectangular surface or return, specify hutch width to match surface width. When attaching hutch to an extended corner surface or a corner application with a rectangular surface and return, specify hutch width 1" less than overall width.

Order optional task lights and accessories separately:

- Cord manager (FV984.)
- Performance task light (G6114.xxxT)
- Utility task light (G6136.xxT)

For keyed-alike locks, see Keyed-Alike Information in Appendices.

Dimensions

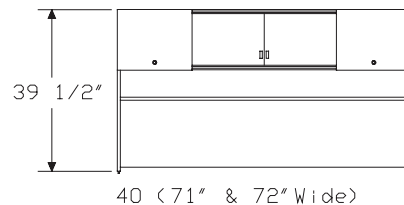
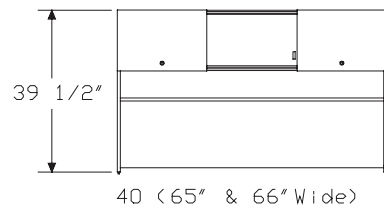
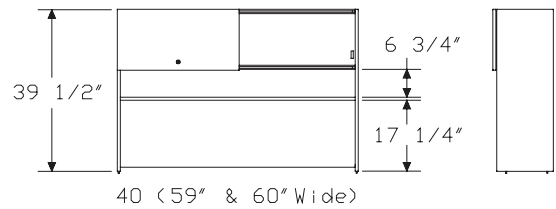
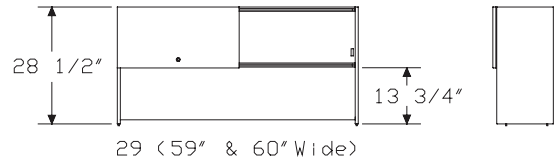
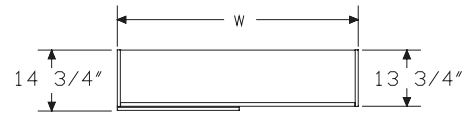

Specification Information

Step 1.

FV451.

Step 2. Height

- 29** 28½" high
- 40** 39½" high

Step 3. Width

- 59** 59" wide
- 60** 60" wide
- 65** 65" wide
- 66** 66" wide
- 71** 71" wide
- 72** 72" wide

Step 4. Case/Primary Door Material

- L** laminate
- C** laminate case/veneer door A
- W** veneer A

Step 5. Secondary Door Material

- A** translucent plastic
- P** painted

Step 6. Lock

- N** no lock
- L** lock

Prices for Steps 1-6.

	LAN	LAL	LPN	LPL	CAN	CAL
FV451. 29 59	\$1909	1921	1826	1838	2222	2234
60	\$1909	1921	1826	1838	2222	2234
65	\$2044	2054	1953	1965	2369	2379
66	\$2044	2054	1953	1965	2369	2379
71	\$2175	2197	2082	2104	2513	2536
72	\$2175	2197	2082	2104	2513	2536
40 59	\$2138	2150	2046	2056	2489	2500
60	\$2138	2150	2046	2056	2489	2500
65	\$2288	2298	2188	2198	2651	2663
66	\$2288	2298	2188	2198	2651	2663
71	\$2437	2459	2331	2353	2814	2837
72	\$2437	2459	2331	2353	2814	2837

	CPN	CPL	WAN	WAL	WPN	WPL
FV451. 29 59	\$2127	2137	3777	3788	3612	3624
60	\$2127	2137	3777	3788	3612	3624
65	\$2266	2276	4024	4035	3850	3860
66	\$2266	2276	4024	4035	3850	3860
71	\$2404	2426	4272	4293	4086	4107
72	\$2404	2426	4272	4293	4086	4107
40 59	\$2380	2391	4230	4241	4046	4058
60	\$2380	2391	4230	4241	4046	4058
65	\$2537	2548	4507	4518	4310	4322
66	\$2537	2548	4507	4518	4310	4322
71	\$2692	2714	4783	4805	4576	4597
72	\$2692	2714	4783	4805	4576	4597

Step 7. Lock Option

- For lock (L)*
- KA** keyed alike -\$10
 - KC** keyed differently, chrome +\$0

Step 8. Case/Stanchion Finish

- Solid-Color Laminate
- For 59" wide (59), 60" wide (60), 65" wide (65), 66" wide (66), 71" wide (71), or 72" wide (72) with laminate (L), or laminate case/veneer door (C)*
- 8Q** folkstone grey +\$0
 - 91** white +\$0
 - 98** studio white +\$0
 - CL** cool grey neutral +\$0
 - LU** soft white +\$0
 - WL** sandstone +\$0
 - WN** warm grey neutral +\$0

- Linen Laminate
- For 59" wide (59) or 60" wide (60) with laminate (L), or laminate case/veneer door (C)*
- LBM** crisp linen +\$0
 - LBN** classic linen +\$0
 - LBP** casual linen +\$0

- Mesh Laminate
- For 59" wide (59) or 60" wide (60) with laminate (L), or laminate case/veneer door (C)*
- LBK** pewter mesh +\$0
 - LBL** steel mesh +\$0

Hutch, Full Enclosure *continued*

Twill Laminate

For 59" wide (59) or 60" wide (60) with laminate (L), or laminate case/
veneer door (C)

LBF	neutral twill	+\$0
LBG	sarum twill	+\$0
LBH	earthen twill	+\$0
LBJ	graphite twill	+\$0
LBQ	white twill	+\$0

Wood-Grain Laminate

For 59" wide (59) or 60" wide (60) with laminate (L), or laminate case/
veneer door (C)

HM	natural maple	+\$0
HP	light anigre	+\$0
LBA	clear on ash	+\$0
LBR	phantom ecru	+\$0
LBS	phantom cocoa	+\$0
LBU	medium matte walnut	+\$0
LBV	warm grey teak	+\$0
LBB	oak on ash	+\$0
LBC	walnut on ash	+\$0
LBD	dark brown walnut	+\$0
LBE	medium red walnut	+\$0
76	light brown walnut	+\$0
HX	aged cherry	+\$0
HY	walnut on cherry	+\$0

Wood Veneer

For veneer (W)

2U	light brown walnut A	+\$0
40	dark brown walnut A	+\$0
ED	aged cherry A	+\$0
EK	medium red walnut A	+\$0
EW	medium matte walnut A	+\$0
ET	clear on ash A	+\$0
EU	oak on ash A	+\$0
EV	walnut on ash A	+\$0
UL	natural maple A	+\$0
UX	walnut on cherry A	+\$0

Step 9. Primary Door Finish

Solid-Color Laminate

For laminate (L)

8Q	folkstone grey	+\$0
91	white	+\$0
98	studio white	+\$0
CL	cool grey neutral	+\$0
LU	soft white	+\$0
WL	sandstone	+\$0
WN	warm grey neutral	+\$0

Linen Laminate

For laminate (L)

LBM	crisp linen	+\$0
LBN	classic linen	+\$0
LBP	casual linen	+\$0

Mesh Laminate

For laminate (L)

LBK	pewter mesh	+\$0
LBL	steel mesh	+\$0

Twill Laminate

For laminate (L)

LBF	neutral twill	+\$0
LBG	sarum twill	+\$0
LBH	earthen twill	+\$0
LBJ	graphite twill	+\$0
LBQ	white twill	+\$0

Wood-Grain Laminate

For laminate (L)

HM	natural maple	+\$0
HP	light anigre	+\$0
LBA	clear on ash	+\$0
LBR	phantom ecru	+\$0
LBS	phantom cocoa	+\$0
LBU	medium matte walnut	+\$0
LBV	warm grey teak	+\$0
LBB	oak on ash	+\$0
LBC	walnut on ash	+\$0
LBD	dark brown walnut	+\$0
LBE	medium red walnut	+\$0
76	light brown walnut	+\$0
HX	aged cherry	+\$0
HY	walnut on cherry	+\$0

Hutch, Full Enclosure *continued*

Wood Veneer

For laminate case/veneer door (C) or veneer (W)

2U	light brown walnut A	+\$0
40	dark brown walnut A	+\$0
ED	aged cherry A	+\$0
EK	medium red walnut A	+\$0
EW	medium matte walnut A	+\$0
ET	clear on ash A	+\$0
EU	oak on ash A	+\$0
EV	walnut on ash A	+\$0
UL	natural maple A	+\$0
UX	walnut on cherry A	+\$0

Step 10. Secondary Door Finish

Translucent Plastic

For translucent plastic (A)

J9	opal frosted	+\$0
-----------	--------------	------

Sand Texture Paint

For painted (P)

8Q	folkstone grey	+\$0
98	studio white	+\$0
WL	sandstone	+\$0

Bright Sand Texture Paint

For painted (P)

91	white	+\$0
CL	cool grey neutral	+\$0
G1	graphite	+\$0
WN	warm grey neutral	+\$0

Metallic Paint

For painted (P)

CN	metallic champagne	+\$0
EH	metallic bronze	+\$0
MS	metallic silver	+\$0

Grommet Kit, Storage

FV983.

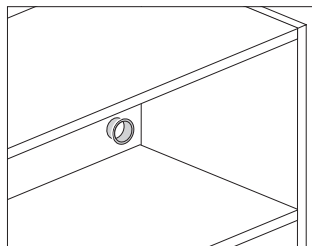

Product Information

Description

This grommet kit allows cords and cables to be routed through a storage cabinet. Includes a template for proper placement. Package of 6.

Notes

Grommet kit requires field-drilling of cabinet.

Dimensions

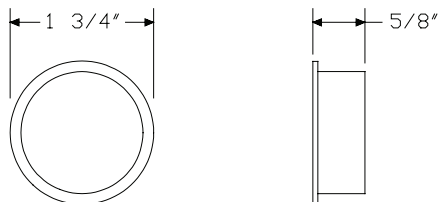

Specification Information

Step 1.

FV983.	\$89
---------------	------

Step 2. Grommet Finish

A	light finish	+ \$0
B	medium finish	+ \$0
C	dark finish	+ \$0

Cord Manager

FV984.

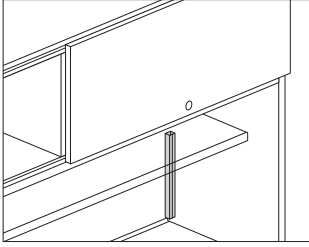

Product Information

Description
 This cord manager routes a cord from the underside of a hutch to the surface when a task light is attached. Color is black. Package of 6.

Dimensions

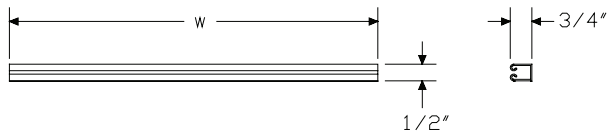

Specification Information

Step 1.

FV984.

Step 2. Height

- 12** 12" high
- 24** 24" high
- 30** 29 1/2" high

Prices for Steps 1-2.

FV984. 12	\$77
24	\$117
30	\$142

Canvas Office Landscape® Storage Accessories

Tackboard

FV980.

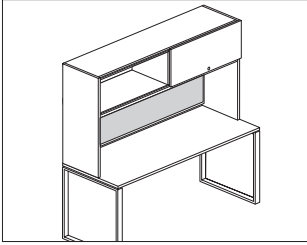

Product Information

Description

This tackboard attaches below a hutch or to an architectural wall.

Notes

For additional product options, see Vary Easy Program in Appendices.

For hutch-mount option (HM), match tackboard width to hutch width.

Vary Easy Program offers the tackboard in 15"- to 30"-high in 1" increments and 24"-72"-wide in 1" increments

Tackboard accepts Customer's Own Material (COM). Yardage is estimated for directional, 54"-wide fabrics.

For hutch mounted (HM) with tackable fabric, horizontal (R)

Width—Yardage

59", 60"—1.86

65", 66"—2.02

71", 72"—2.19

For wall mounted (WM) with tackable fabric (T)

Height—Yardage

12"—.58

16"—.69

23"—.88

24"—.91

30"—1.05

For wall mounted (WM) with tackable fabric, horizontal (R)

Width—Yardage

24"—.91

30"—1.08

36"—1.25

42"—1.41

48"—1.58

54"—1.75

60"—1.91

66"—2.08

72"—2.25

For information on multiple quantities or nondirectional fabrics, contact COM Department. See Order Information in Appendices.

Dimensions

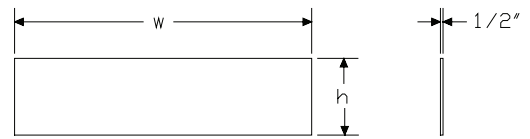

Specification Information

Step 1.

FV980.

Step 2. Mount Option

HM hutch mounted

WM wall mount

Step 3. Height

For hutch mounted (HM)

12 12" high

15 15" high

For wall mount (WM)

12 12" high

16 16" high

23 23" high

24 24" high

29 28½" high

Step 4. Width

For hutch mounted (HM)

59 59" wide

60 60" wide

65 65" wide

66 66" wide

71 71" wide

72 72" wide

For wall mount (WM)

24 24" wide

30 30" wide

36 36" wide

42 42" wide

48 48" wide

54 54" wide

60 60" wide

66 66" wide

72 72" wide

Step 5. Surface Material

For 24" wide (24), 30" wide (30), 36" wide (36), 42" wide (42), or 48" wide (48)

T tackable fabric

R tackable fabric, horizontal

For 54" wide (54), 59" wide (59), 60" wide (60), 65" wide (65), 66" wide (66), 71" wide (71), or 72" wide (72)

R tackable fabric, horizontal

Prices for Steps 1-5.

		24T	24R	30T	30R	36T	36R
FV980. WM	12	\$130	130	162	162	190	190
	16	\$154	154	185	185	217	217
	23	\$275	275	308	308	337	337
	24	\$275	275	308	308	337	337
	29	\$311	311	344	344	375	375
		42T	42R	48T	48R	54R	59R
FV980. HM	12	—	—	—	—	—	\$321
	15	—	—	—	—	—	\$332
	WM 12	\$225	225	260	260	308	—
	16	\$250	250	283	283	332	—
	23	\$372	372	407	407	490	—
	24	\$372	372	407	407	490	—
	29	\$409	409	441	441	527	—
		60R	65R	66R	71R	72R	
FV980. HM	12	\$321	332	332	344	344	
	15	\$332	344	344	357	357	
	WM 12	\$321	—	332	—	344	
	16	\$344	—	357	—	368	
	23	\$502	—	516	—	527	
	24	\$502	—	516	—	527	
	29	\$539	—	552	—	563	

Tackboard *continued*

Step 6. Fabric

See application chart and textiles list for fabric usage and numbers.

First 2 digits of number indicate fabric line; remaining digit(s) indicate fabric color.

	12	15	16	23	24
Price Category 1	+\$0	0	0	0	0
Price Category 2	+\$19	21	21	25	25
Price Category 3	+\$33	37	37	42	42
Price Category 4	+\$51	55	55	66	66
Price Category 5	+\$103	113	113	136	136
Price Category B	+\$35	41	41	52	54
Price Category C	+\$47	56	56	72	74
Price Category D	+\$60	71	71	91	94
Price Category E	+\$72	86	86	110	114
Price Category F	+\$94	111	111	142	147
Price Category G	+\$122	145	145	184	191
				29	
Price Category 1					+\$0
Price Category 2					+\$31
Price Category 3					+\$49
Price Category 4					+\$73
Price Category 5					+\$146
Price Category B					+\$63
Price Category C					+\$86
Price Category D					+\$108
Price Category E					+\$131
Price Category F					+\$169
Price Category G					+\$220

Tackboard Cable Manager

FV985.

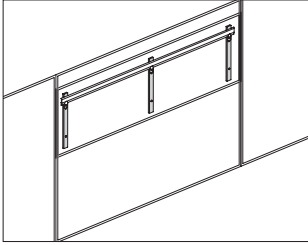

Product Information

Description

This spacer strip allows for cable management behind a tackboard used in a wall-mount application. Package contains 12. Finish is black.

Notes

Attachment hardware must be customer supplied.

Specify spacer strip as follows:

Tackboard size—spacer required

12"–14" (must be field cut to accommodate 12" tackboard)

16"–14"

23"–21"

24"–21"

29"–27"

Recommended maximum of 16" spacing between spacer strips.

Dimensions

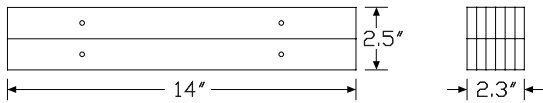

Specification Information

Step 1.

FV985. A

Step 2. Size

14 for use with 12" and 16" high A

21 for use with 23" and 24" high A

27 for use with 29" high A

Prices for Steps 1-2.

FV985. 14	\$133
21	\$140
27	\$150

Index by Product Name

Canvas Office Landscape® Freestanding and Surface Attached Storage

Bookcase Hutch, Storage Attached	page(s) 284
Canvas Cabinet/Wall Attachment Bracket	283
Cord Manager	308
Grommet Kit, Storage	307
Hutch, Full Enclosure	303
Hutch, Partial Enclosure	299
Hutch, Partial Enclosure, Storage Attached	294
Tackboard	309
Tackboard Cable Manager	312
Wardrobe Hutch, Storage Attached	289

Canvas Office Landscape® Metal Storage

Canvas Vertical Tower Attachment Bracket	page(s) 35
Connect™-Block Connector, 4-Circuit	107
Connect™-Junction Block to Junction Block Jumper, 4-Circuit	105
Connect™-Power Entry, 4-Circuit	104
Connect™ - S310 Electrical Unit with Connect Modular Connection	103
Credenza Cushion Top	97
Credenza Top for Metal Credenza	95
Credenza Top for Metal Credenza, with Pari Screen, Storage Attached	91
Drawer Divider for Box Drawer	22
Drawer Organizer Kit	23
File Compressor	25
File Drawer Organizer	111, 26, 12
Front-to-Back Filing Rail	108, 9
Meridian® Vertical Tower Attachment Bracket	37
Metal Credenza Shelf	90
Metal Freestanding Lateral File	5
Metal Freestanding Pedestal	13
Metal High Credenza, Open	67
Metal High Credenza, with Doors	69
Metal Low Credenza, Doors with Drawers	59
Metal Low Credenza, Open	38
Metal Low Credenza, Open with Drawers	51
Metal Low Credenza, with Doors	41
Metal Low Credenza, with Drawers	46
Metal Mobile Pedestal	17
Metal Vertical Tower, Thin Top	27
Metal Vertical Tower, Thin Top Side Facing Bookcase	32
Movable Divider	110, 11
Open Shelf Organizer	112
Open Shelf Organizer, Divider	114
Pari Screen, Storage Attached	93
Pedestal Cushion Top	20
Pencil Tray for Box Drawer	21
Powered Metal Low Credenza, Doors with Drawers	84

Powered Metal Low Credenza, Open with Drawers	77
Powered Metal Low Credenza, with Drawers	73
Powered Storage Cable Cover	100
Powered Storage Distributor Cover	102
Powered Storage Ganging Bracket Kit	99
Side-to-Side Filing Rail	109, 10
Stationary Tray for Box Drawer	24
Support Bracket, Low Credenza-to-Frame	98
Tu® Storage Tower Attachment Bracket	36

Canvas Office Landscape® Wood Storage

Canvas Cabinet/Wall Attachment Bracket	page(s) 144
Connect™-Block Connector, 4-Circuit	276
Connect™-Junction Block to Junction Block Jumper, 4-Circuit	274
Connect™-Power Entry, 4-Circuit	273
Connect™ - S310 Electrical Unit with Connect Modular Connection	272
Credenza Cushion Top	249
Credenza Top for Wood Credenza	245
Credenza Top for Wood Credenza, with Pari Screen, Storage Attached	243
Open Shelf Organizer	277
Open Shelf Organizer Attachment Bracket	280
Open Shelf Organizer, Divider	279
Pari Screen, Storage Attached	247
Pedestal Cushion Top	130
Powered Storage Cable Cover	258
Powered Storage Distributor Cover	271
Powered Storage Ganging Bracket Kit	252
Powered Wood Low Credenza, Doors with Drawers	266
Powered Wood Low Credenza, Open with Drawers	260
Powered Wood Low Credenza, with Drawers	253
Support Bracket, Low Credenza-to-Frame	239
Thick Top, 27" High Wood Storage	240
Wood Credenza Shelf	250
Wood Freestanding Bookcase	172, 145
Wood Freestanding Lateral File	117
Wood Freestanding Pedestal	121
Wood High Credenza, Open	232
Wood High Credenza, Open with Access to Power	229
Wood High Credenza, with Doors	235
Wood Low Credenza, Doors with Drawers	212
Wood Low Credenza, Open	176
Wood Low Credenza, Open, Height Adjustable Leg Integration	219
Wood Low Credenza, Open, Power Access	224
Wood Low Credenza, Open with Drawers	191
Wood Low Credenza, Open with Drawers, Height Adjustable Leg Integration	199
Wood Low Credenza, Open with Drawers, Power Access	206

Index by Product Name *continued*

Index: Product Name

Wood Low Credenza, with Doors	180
Wood Low Credenza, with Drawers	185
Wood Mobile Pedestal	126
Wood Vertical Storage Cabinet, Thin Top	164
Wood Vertical Tower	131
Wood Vertical Tower with Lower Storage	138
Wood Vertical Tower with Partial Enclosure	158
Wood Wardrobe Tower	151

Index by Product Number

FF10A. Wood Freestanding Pedestal	page(s) 121	FFV73K	
FF10K.		FFV700 Wood Low Credenza, Open, Power Access	224
FF11A. Wood Mobile Pedestal	126	FFV800 Wood High Credenza, Open with Access to Power	229
FF11K.		FM10A. Metal Freestanding Pedestal	13
FF20A. Wood Freestanding Lateral File	117	FM10K.	
FF20K.		FM11A. Metal Mobile Pedestal	17
FF50M. Wood Vertical Storage Cabinet, Thin Top	164	FM11K.	
FF52M. Wood Vertical Tower	131	FM20A. Metal Freestanding Lateral File	5
FF53M. Wood Vertical Tower with Lower Storage	138	FM20K.	
FF54M. Wood Freestanding Bookcase	145	FM71A. Metal Low Credenza, with Doors	41
FF55M. Wood Wardrobe Tower	151	FM71K.	
FF56M. Wood Vertical Tower with Partial Enclosure	158	FM72A. Metal Low Credenza, with Drawers	46
FF81A. Wood High Credenza, with Doors	235	FM72K.	
FF81K.		FM73A. Metal Low Credenza, Open with Drawers	51
FF300. Wood Freestanding Bookcase	172	FM73K.	
FF800. Wood High Credenza, Open	232	FM74A. Metal Low Credenza, Doors with Drawers	59
FF888. Thick Top, 27" High Wood Storage	240	FM74K.	
FF889. Credenza Top for Wood Credenza, with Pari Screen, Storage Attached	243	FM80A. Metal High Credenza, with Doors	69
FF890. Credenza Top for Wood Credenza	245	FM80K.	
FF891. Credenza Cushion Top	249, 97	FM90A. Metal Vertical Tower, Thin Top	27
FF892. Wood Credenza Shelf	250	FM90K.	
FF893. Pedestal Cushion Top	130	FM91A. Metal Vertical Tower, Thin Top Side Facing Bookcase	32
FF900. Open Shelf Organizer	277, 112	FM91K.	
FF901. Open Shelf Organizer, Divider	279, 114	FM700. Metal Low Credenza, Open	38
FF902. Open Shelf Organizer Attachment Bracket	280	FM800. Metal High Credenza, Open	67
FFC71A Wood Low Credenza, with Doors	180	FM889. Credenza Top for Metal Credenza, with Pari Screen, Storage Attached	91
FFC71K		FM890. Credenza Top for Metal Credenza	95
FFC72A Wood Low Credenza, with Drawers	185	FM892. Metal Credenza Shelf	90
FFC72K		FM893. Pedestal Cushion Top	20
FFC73A Wood Low Credenza, Open with Drawers	191	FM920. Front-to-Back Filing Rail	108, 9
FFC73K		FM921. Side-to-Side Filing Rail	109, 10
FFC74A Wood Low Credenza, Doors with Drawers	212	FM922. Movable Divider	110, 11
FFC74K		FM923. File Drawer Organizer	111, 26, 12
FFC700 Wood Low Credenza, Open	176	FM924. Pencil Tray for Box Drawer	21
FFD72A Powered Wood Low Credenza, with Drawers	253	FM925. Drawer Divider for Box Drawer	22
FFD72K		FM926. Drawer Organizer Kit	23
FFD73A Powered Wood Low Credenza, Open with Drawers	260	FM927. Stationary Tray for Box Drawer	24
FFD73K		FM928. File Compressor	25
FFD74A Powered Wood Low Credenza, Doors with Drawers	266	FM929. Movable Divider	110, 11
FFD74K		FM930. Canvas Vertical Tower Attachment Bracket	35
FFH73A Wood Low Credenza, Open with Drawers, Height Adjustable Leg Integration	199	FMP72A Powered Metal Low Credenza, with Drawers	73
FFH73K		FMP72K	
FFH700 Wood Low Credenza, Open, Height Adjustable Leg Integration	219	FMP73A Powered Metal Low Credenza, Open with Drawers	77
FFV73A Wood Low Credenza, Open with Drawers, Power Access	206	FMP73K	
		FMP74A Powered Metal Low Credenza, Doors with Drawers	84
		FMP74K	

Index by Product Number *continued*

Index: Product Number

FPS910	Powered Storage Cable Cover	258, 100
FPS911	Powered Storage Distributor Cover	271, 102
FT292.	Support Bracket, Low Credenza-to-Frame	239, 98
FV360.	Pari Screen, Storage Attached	247, 93
FV450.	Hutch, Partial Enclosure	299
FV451.	Hutch, Full Enclosure	303
FV454.	Bookcase Hutch, Storage Attached	284
FV455.	Wardrobe Hutch, Storage Attached	289
FV456.	Hutch, Partial Enclosure, Storage Attached	294
FV692.	Canvas Cabinet/Wall Attachment Bracket	283, 144
FV980.	Tackboard	309
FV983.	Grommet Kit, Storage	307
FV984.	Cord Manager	308
FV985.	Tackboard Cable Manager	312
LG692	Tu® Storage Tower Attachment Bracket	36
MTAB.	Meridian® Vertical Tower Attachment Bracket	37
PS900	Powered Storage Ganging Bracket Kit	252, 99
Y1329.	Connect™ - S310 Electrical Unit with Connect Modular Connection	272, 103
Y1351.	Connect™-Power Entry, 4-Circuit	273, 104
Y1353.	Connect™-Junction Block to Junction Block Jumper, 4-Circuit	274, 105
Y1354.	Connect™-Block Connector, 4-Circuit	276, 107

20-Day or Less/Assigned Lead-Time Order Information

20-Day or Less and Assigned Lead-Time Programs

20-day or less and assigned lead-time products are designed for established Herman Miller dealers with pre-approved credit.

Products are distributed from multiple manufacturing facilities across the United States. All products and options not designated by an Assigned Lead-Time icon **A** will ship in 20 business days or less after being acknowledged by Herman Miller. Products and options designated by an **A** are on the assigned lead-time program and will ship in 20 days, less than 20 days, or more than 20 days from order acknowledgement.

Ordering Procedure

Please place orders through Order Manager. If this is not available to you, place orders through mail or fax. Verbal purchase orders will not be accepted.

Order Entry fax number for Passage®, 5000 Series, and Meridian® Filing and Storage: (616) 846 9236.

Order Entry fax number for all other products:
(616) 654 3085.

For more information, contact your Customer Care representative at:
(866) 854 3048 EXT 3400.

Shipments and Delivery

Per Herman Miller Terms and Conditions.

Changes and Cancellation

Per Herman Miller Terms and Conditions.



Keyed-Alike Information

Keyed-Alike Locks

All components with locks may be specified keyed alike. Products with keyed-alike locks will be shipped with lock chassis installed.

Installation of lock cylinders will be on-site according to instructions provided. Herman Miller, Inc., will not be responsible for lock cylinder installation.

When specifying product keyed-alike, include separate lines on your order for the lock cylinders.

For Action Office®, Ethospace®, Passage®, Quadrant®, Resolve®, and Supplemental products, list cylinder part number and key number (232092-XXX); select a key number (or numbers) between 226 and 427, excluding numbers 408 and 412.

The following products require a different lock cylinder part number. Specify UKY001-XXX for these products only; select a key number (or numbers) between 226 and 427, excluding numbers 408 and 412.

- A3013.
- A3053.
- G5180.
- G5181.
- G5280.

The keys provided in 232092-XXX and UKY001-XXX kits work with either cylinder type, provided the key numbers match.

For Tu® Storage, Canvas Office Landscape®, 5000 Series, and Meridian® Storage, see the following charts.

Keyed-alike locks are field installed.

To order keyed-alike locks for Action Office® Series 1 and 2 door panels, please contact Customer Care.

A master key can be used to open any lock on an attached or freestanding component. In addition, a removal key or lock change tool is required to remove lock plugs. Customers interested in ordering master keys, removal keys, or lock change tools should contact Customer Care.

For Canvas overhead and lower storage units, specify as follows:

Specification Code	Part Number	Color	Lock Series
KA	1B2JK7-XXX ¹	chrome	UM series 226-427

For Canvas Metal Storage, Meridian Storage, Tu Storage, and 5000 Series desk components with pedestals, specify as follows:

Specification Code	Key Number	Color	Lock Series
KA	232092-XXX ¹	black	UM series 226-427
KA	1B2JK7-XXX ¹	chrome	UM series 226-427

For 5000 Series flipper door unit with bezel or credenza storage cabinet with bezel, specify as follows:

Specification Code	Key Number	Color	Lock Series
KA	232092-XXX ¹	black	UM series 226-427

Key Number:

XXX¹ = a key number between 226 and 427 (excluding 408 and 412)

Vary Easy Program

Program Overview

Vary Easy is a program designed to help dealers specify standard products with a larger breadth of options. For example, depending on the type of product being specified, choices include additional size, finish, edge types, and cable management features. Vary Easy 3D, specIT, and third-party text-based specification packages support the Vary Easy program. Vary Easy 3D enables designers to create a 3D image, CAD symbols, and a price book page. A Vary Easy product number is assigned for each product as the user selects specific options. Once the product is completely specified, the order can be submitted via Kiosk's Order Manager or a dealer's business system.

Accessing and Specifying Vary Easy

To view the full product vocabulary, go to the Vary Easy Product Offering on Kiosk. To specify Vary Easy, go to the Vary Easy 3D website on Kiosk, specIT, or your third-party text-based specification package.

Once you've made your product line selection, continue to follow through each option and enter the specific options that represent the product you need. When the product is fully specified, Vary Easy will generate an orderable product number and instantly calculate a price.

Note: Failure to completely specify a product will cause a delay in order acknowledgements. Be sure to make a selection for all options offered.

The acknowledgement process for Vary Easy products is the same as for any standard order. Vary Easy products ship with a standardized lead time and are competitively priced.

For more information, contact your Customer Care Line at (866) 854 3048 EXT 3400.

Stain-to-Match Program

Stain-to-Match Program

Program Overview

The Stain-to-Match program gives you the option of using veneer finishes that are not listed in the standard offering. The program allows Herman Miller to match a customer's existing recut or natural veneer, or create a new finish that is unique to an installation.

Specific information on approval, ordering, pricing, and warranty for the Stain-to-Match program is listed below. Questions and requests for assistance may be directed to Herman Miller Options at:

(800) 654 3910

Ordering Products with Stain-to-Match Veneers

1. Fill out the Options Stain-to-Match Request Form and send along with a color sample (2" x 3" minimum) to the Herman Miller Options Applications Team at the address provided on the form. The form can be found on Omni.
2. Within 7-10 working days, Herman Miller Options will send a sample of the color-matched stain on Herman Miller veneer to the requester for the customer's signed approval.
3. If the sample meets the customer's approval, sign the reverse side of the sample, scan and email the approval to:
options@hermanmiller.com.
4. After the stain has been approved, a formal quotation with special number and pricing can be provided, or the product can be specified through the Vary Easy program, if available. Work with the Options team on final product needs and how to specify.
5. A purchase order can then be placed.

Stain-to-Match Warranty

Herman Miller warrants its products to be free from defects in craftsmanship from the date of delivery for the applicable warranty period. Herman Miller is responsible for the physical properties of the veneers available through the Stain-to-Match program, which include:

- STA: Stain-to-Match on Recut Ash
- STB: Stain-to-Match on Beech
- STC: Stain-to-Match on Cherry
- STD: Stain-to-Match on Oak
- STK: Stain-to-Match on Reltech Anigre (Geiger)
- STM: Stain-to-Match on Recut Mahogany
- STP: Stain-to-Match on Maple
- STU: Stain-to-Match on Walnut (Geiger)

See your specification tool for product specific finish offering limitations.



Customer's Own Material/ Customer's Own Leather Order Information — Cushion Tops

Customer's Own Material/Customer's Own Leather

Program Overview

The Customer's Own Material (COM) and Customer's Own Leather (COL) program gives you the option of using textiles other than those listed. Herman Miller will test textiles for application to Herman Miller products and will process orders for those with approved COM/COL textiles only. COM/COL are assigned lead time textiles.

Omni lists an overview of fabrics and leathers that have been tested and indicates whether or not they were approved for application to Herman Miller products.

Specific information on the terms and conditions, testing, approval, and ordering process for COM/COL is listed below. Questions about the COM/COL program and requests for assistance may be directed to your COM representative at:

(616) 654 3400

(866) 854 3048 EXT 6543400

Customer's Own Material/Customer's Own Leather Warranty

Herman Miller does not warrant COM/COL textiles. COM/COL textiles are tested for application only; they are not tested for performance. The Herman Miller warranty does apply to the underlying products.

Suppliers of COM/COL textiles are responsible for color consistency within commercial tolerances, UV stability, and resistance to soiling and perspiration.

Customer's Own Material/Customer's Own Leather Pricing

COM is a Category 1 fabric. There are no application charges for COM fabrics. COL is a Category 7 textile; refer to prices on specific products to determine the application charge.

Ordering and payment for COM/COL textile yardage are the responsibility of the customer and the textile supplier.

If desired, Herman Miller will purchase COM textiles directly from True Textiles, C.F. Stinson, Luna Textiles, Maharam, and Momentum Textiles to simplify ordering and shipment. For this service, refer to the Supplier Connection program.

Application Note

Herman Miller does not guarantee that Customer's Own Material (COM) fabric patterns will align across panels/tiles or from one screen to the next. We also do not guarantee that COM fabric designs will be positioned consistently in the same location across several panels, tiles, or screens.

Textile Approval

1. Select a COM/COL textile.
2. If your textile is not listed on Omni, obtain a test number from a COM representative at (616) 654 3400. You can also submit your request within Omni. Please have the following information ready before calling: textile name, number, pattern, and the product you will apply it to.
3. Herman Miller will notify you of approval or disapproval within 4 days from receipt of the test yardage.

Customer's Own Material/ Customer's Own Leather Order Information — Cushion Tops

continued

Ordering Products with COM/COL

1. Refer to the specific products to determine the yardage required for COM/COL textiles.
2. If your textile is not listed on Omni, call a COM representative at (616) 654 3400 or (866) 854 3048 EXT 6543400. The representative will assign an identification number for your textile (ID#) and will verify yardage requirements for your order. Yardage requirements are based on directional, 54"-wide textiles. Additional yardage may be needed due to the unique characteristics of a textile.
3. Enter your order on Order Manager in Omni.
4. Upon receipt of your purchase order, Herman Miller will send you a PO acknowledgment.
5. Arrangements must be made for the textiles to be shipped from the supplier to Herman Miller for application to the seating products. See Omni for shipping procedures and current shipping addresses or contact a COM representative at (616) 654 3400 or (866) 854 3048 EXT 6543400.

Products will be scheduled for production when COM/COL textiles are received at Herman Miller. Standard lead times in effect at that time will apply.

Note: If textiles are to be purchased directly by Herman Miller through the Supplier Connection program, Herman Miller will handle the ordering and shipping process and will schedule your order for production upon receipt of your purchase order (dependent on textile availability). Refer to the Supplier Connection program for more information.

Supplier Connection

Program Overview

The Supplier Connection program is a service offered by Herman Miller to purchase approved COM textiles directly from True Textiles, C.F. Stinson, Luna Textiles, Maharam, and Momentum Textiles. When you select a textile through this program, Herman Miller will facilitate the ordering, scheduling, and shipment of the textile directly with the supplier.

Suppliers included in the Supplier Connection program keep an active inventory of textiles that are pre-approved for application to Herman Miller products. Pre-approval applies only to the suitability of a textile for manufacturing and application to a Herman Miller product. Omni provides an overview of fabrics that have been tested and indicates whether or not they were approved for application to Herman Miller products.

Specific information on the terms and conditions, testing, approval, and ordering process for the Supplier Connection program is listed below. Questions and requests for assistance may be directed to your COM representative at:

(616) 654 3400
(866) 854 3048 EXT 6543400

Supplier Connection Warranty

Textiles purchased by Herman Miller through the Supplier Connection program are COM and are not warranted by Herman Miller. COM textiles are tested for application only; they are not tested for performance. The Herman Miller warranty does apply to the underlying products.

Suppliers of COM textiles are responsible for color consistency within commercial tolerances, UV stability, and resistance to soiling and perspiration.

Customer's Own Material/ Customer's Own Leather Order Information — Cushion Tops

continued

Supplier Connection Pricing

Textiles purchased by Herman Miller through the Supplier Connection program are COM. COM is a Category 1 fabric. There are no application charges for COM fabrics.

Payment for textiles purchased by Herman Miller through the Supplier Connection program is the responsibility of the customer or dealer. Herman Miller will invoice the order at the supplier's prices published at the time of the order.

Textile Approval

1. Refer to Omni to identify the approval status of the textile. If your textile is not listed, contact the COM Department to request testing for application to Herman Miller products.
2. Herman Miller will notify you of approval or disapproval in approximately 4 days from receipt of the test yardage. If the textile is approved, it will be assigned a COM identification number.

Ordering Products with Supplier Connection COM

1. Identify and include the following information on your purchase order:
 - Product number and option
 - Herman Miller's COM identification number
2. Enter your order on Order Manager in Omni.
3. Upon receipt of the purchase order, Herman Miller will process your order and send you a PO acknowledgment. Herman Miller will determine the yardage required to produce your product and will order and schedule for delivery the required textile. Standard lead times in effect at the time the textile is allocated at the supplier will apply to products ordered through this program.



Proprietary Textiles Application Chart — Seating

• Available

[A] Assigned lead-time textile.

See following page for exception notes.

[N] Non-woven textile.

Price Category 1

	Aeron® Chairs	Cosm™ Chairs	Mirra® 2 Chairs/Stools	Celle® Chairs/Stools	Embody® Chairs	Sayl® Work Chairs/Stools	Sayl Side Chairs	Setu® Chairs/Stools	Setu Lounge Chair/Ottoman	Verus™ Work Chairs/Stools Back	Verus Work Chairs/Stools Seat	Verus Side Chairs Back	Verus Side Chairs Seat	Equa 2 Fully Upholstered Chairs/Stools	Equa 2 Split-Pad Upholstered Chairs/Stools	Aside® Chairs	Caper® Chairs/Stools	Celeste™ Seating	Keyn Chair Group Back	Keyn Chair Group Seat	Lino™ Chairs Back	Lino Chairs Seat	Locale® Bench Cushion	Public Office Landscape® Back	Public Office Landscape Seat	Plex™ Lounge Furniture	Swoop™ Lounge Seating - Fully Upholstered	Swoop Lounge Seating - Plywood	Eames Tandem Sling Seating	Cushion Tops	Workspaces		
COM Customer's Own Material [A]			14			1	1							1	1	1		1		1		1	1			1	1	1	1	1	1	1	
231__ 8Z Pellicle®	•																																
1A7__ AireWeave™ 2			•																														
3P__ ColorGuard [N]				15		•	22	•	•	•	•	•	•		3	8		•	•	•			•										
8T__ Crossing				•				•	•					•	•	•						•											
3DE__ Dex				14		•	•	•	•	•	•	•	•					•		•				•	19	•							
4RM__ Duo																					•												
6V__ Flexnet™																	•																
95__ Gem				14				•	•					•	•	•		•					•			•	•						
845__ Intercept		•																															
65__ Interweave										•			•																				
4W__ Lyriss 2™								•	•																								
1MN__ Monologue				14		24	22	•	•	•	•	•	•					•	•	•		•	•		•	•	•	•	•	•	•	•	
3DK__ Stretch Knit [A]								21																									
235__ Tailored [A]				•		•	•	•	•	•	•	•	•					•	•	•		•			•	23							
1WS__ Whisper				14		24	•	•	•	•	•	•	•	•	•	•		•	•	•		•	•		•	•	•	•	•	•	•	•	

Price Category 2

3AR__ Aristo				14		•	•	•	•	•	•	•	•				•	•	•	•	•	•	•	•	•	•	•	•	•	•	•	•	•	
92__ Crepe				•		•	•	•	•	•	•	•	•	•	•	•		•	•	•	•	•	•	•	•	•	•	•	•	•	•	•	•	
3EP__ Epic				14		•	•			•	•	•	•					•	•	•		•												
22Q__ Fish Net				•		•	•	•	•	•	•	•	•	•	•	•		•	•	•		•												
1LM__ Loom				14		•	•			•	•	•	•					•	•	•		•	•											
1MV__ Marvel								21	22									•	•															
1HA__ Medley				14		•	•	22		•	•	•	•	•	•	•		•	•	•		•	•		•	•	•	•	•	•	•	•	•	
3A__ Moiré				14		•	•	•	•	•	•	•	•	•	•	•		•	•	•		•	•		•	•	•	•	•	•	•	•	•	
30__ Rhythm						•	23	•	•	•	•	•	•	•	•	•		•	•	•		•	•		•	•	•	•	•	•	•	•	•	
1RV__ Rivet				14		21	22			•	•	•	•	•	•	•		•	•	•		•	•		•	•	•	•	•	•	•	•	•	
8R__ Twist				•		•	•	•	•	•	•	•	•	•	•	•		•	•	•		•	•		•	•	•	•	•	•	•	•	•	
22T__ Well Suited														•	8											•	23						•	

Price Category 3

3AC__ Ace [N]						21	•			•	•	•	•	•	3	8		•	•	•		•	•		•	19						•		
70__ Bento							•	•	•	•	•	•	•	•	•	8						•											•	
8M__ Latitude™					23		•								3							•												
22R__ Pins and Needles				14		•	•	•		•	•	•	•	•	•	•		•	•	•					•		•							
8U__ Stitches				•		•	•	•	•	•	•	•	•	•	•	•		•	•	•		•	•		•	•	•	•	•	•	•	•	•	
22V__ String Plaid				14		•	•			•	•	•	•					•	•	•		•	•		•									

Price Category 4

7Y__ Bingo [N]						•	•	•	•	•	•	•	•	•	3	8		•	•	•		•											•	
1DL__ Dialogue																							•											
213__ Mercer				14		•	21	22		•	•	•	•					•	•	•		•		•			•	•	•	•	•	•	•	
1A9__ Network																							•											
6J__ Plateau														•	•	•																		•
6S__ Quilty				14		•	•			•	•	•	•					•	•	•		•	•				•	•	•	•	•	•	•	•
8Y__ Spools				14		21	•	•	•	•	•	•	•	•	•	•		•	•	•		•	•		•	•	•	•	•	•	•	•	•	•
22P__ Strata						•	•	•		•	•	•	•					•	•	•		•	•		•	•	•	•	•	•	•	•	•	•

continued on next page

Proprietary Textiles Application Chart — Seating

continued

- Available

[A] Assigned lead-time textile.

See below for exception notes.

[N] Non-woven textile.

	Aeron® Chairs	Cosm™ Chairs	Mirra® 2 Chairs/Stools	Celle® Chairs/Stools	Embody® Chairs	Sayl® Work Chairs/Stools	Sayl Side Chairs	Setu® Chairs/Stools	Setu Lounge Chair/Ottoman	Verus™ Work Chairs/Stools Back	Verus Work Chairs/Stools Seat	Verus Side Chairs Back	Verus Side Chairs Seat	Equa 2 Fully Upholstered Chairs/Stools	Equa 2 Split-Pad Upholstered Chairs/Stools	Aside® Chairs	Caper® Chairs/Stools	Celeste™ Seating	Keyn Chair Group Back	Keyn Chair Group Seat	Lino™ Chairs Back	Lino Chairs Seat	Locale® Bench Cushion	Public Office Landscape® Back	Public Office Landscape Seat	Plex™ Lounge Furniture	Swoop™ Lounge Seating - Fully Upholstered	Swoop Lounge Seating - Plywood	Eames Tandem Sling Seating	Cushion Tops	Workspaces					
Price Category 5																																				
14A__ Hopsak			14																																	
22N__ Noble (22H__)			14				25								3	8																				
Price Category 6																																				
35__ Balance					•																															
Price Category 7																																				
COL Customer's Own Leather		1	14											1	1	8																			1	
Price Category 8																																				
No fabrics available at this time																																				
Price Category 9																																				
21__ Leather		23	14																																	

continued on next page

Proprietary Textiles Application Chart — Seating

• Available

[A] Assigned lead-time textile.

See following page for exception notes.

[N] Non-woven textile.

All foam and Proprietary Textiles on

HermanMiller seating comply with California TB 117-2013.

Fire-Retardant Chairs/Fabrics

	Aeron® Chairs - Graphite	Mirra® 2 Chairs/Stools with Butterfly Back	Celle® Chairs/Stools	Embody® Chairs	Sayl® Work Chairs/Stools	Sayl Side Chairs	Setu® Chairs/Stools	Setu Lounge Chair/Ottoman	Equa 2® Fully Upholstered Chairs/Stools	Equa 2 Split-Pad Upholstered Chairs/Stools	Aside® Chairs	Caper® Chairs/Stools	Celeste™ Seating	Plex™ Lounge Furniture	Swoop™ Lounge Seating - Fully Upholstered	Fames® Tandem Sling Seating
Price Category 1																
COM Customer's Own Material [A]									1	1	1	1				
23103 8Z Pellicle - Graphite	•															
1A7__ AireWeave™ 2		•														
3P__ ColorGuard [N]			15	24	22				3	8					•	6
8T__ Crossing			14			•	•	•	•	•			•		•	
3DE__ Dex			14		•	•	•			•			•	19	•	
6V__ Flexnet™											•					
95__ Gem			14			•	•	•	•	•			•	•	•	
4W__ Lyris 2™						18	•									
1MN__ Monologue			14	21	22	•	•						•	•	•	
235__ Tailored [A]		•				•							•	•	•	
1WS__ Whisper			14	21	22	•	•	•	•	•			•	•	•	
Price Category 2																
3AR__ Aristo			14		•	•	•	•			•		•	•	•	
92__ Crepe			14		•	•			•	•	•		•	•	•	
3EP__ Epic			14		•	•					•		•	•	•	
22Q__ Fish Net			•	•	•	•								•		
3A__ Moiré			14		•	•	•	•	•	•			•			
30__ Rhythm			14	24	•						8				•	
1RV__ Rivet			14	21	22	•					•		•	•	•	
8R__ Twist			14		•	•	•	•			•	8		•	•	•
Price Category 3																
70__ Bento					•	•	•	•	•		8				•	
8M__ Latitude™			•		•	•										
22R__ Pins and Needles					•	•	•									
8U__ Stitches			14		•	•	•	•	•	•	•			•	•	•
22V__ String Plaid					•								•			
Price Category 4																
6J__ Plateau											•					
6S__ Quilty			14		•	•									•	
Price Category 5																
14A__ Hopsak			14		•			•	•	•	•			•	•	
Price Category 6																
35__ Balance				17												
Price Category 9																
21__ Leather			14								8					

Application Note: Herman Miller cannot guarantee material/pattern alignment in adjacent products. For example, a fabric's pattern may not align from one pedestal cushion top to the next, or from one chair to another.

- 1 Refer to price book appendices and Omni for COM/COL information.
- 3 Available on A-and B-size Equa 2 split-pad upholstered chairs.
- 4 See specific products for information on specifying leather in combination with fabric.
- 6 Only available in 3P02 Navy, 3P03 Spruce, 3P14 Black, 3P19 Slate, and 3PC7 Bucksuede.
- 8 Only available on nonupholstered outer back option (PB).
- 14 Available on Celle UC (upholstered seat) and HC (upholstered seat with protective edge) Chairs.
- 15 Available only on Celle HC (upholstered seat with protective edge) Chairs.
- 17 Only available in 3512 Carbon and 3513 Black.
- 18 Only available in 4W26 Slate Grey, 4W30 Java, and 4W31 Graphite.
- 19 Available on Plex seat only.
- 21 Not available on Sayl upholstered back work chairs.
- 22 Not available on Sayl side chairs with upholstered backs.
- 23 Available in select colors. Refer to "Proprietary Textile Colors-Seating" for color offering.
- 24 Not available on Sayl upholstered High-Back Work Chairs.
- 25 Not available on Sayl side chairs with upholstered backs. Available in select colors. Refer to "Proprietary Textile Colors-Seating" for color offering.



Proprietary Textile Colors — Seating

Price Category 1

Customer's Own Material
See Order Information in
Appendices.
Assigned lead-time textile. A

8Z Pellicle®
For New Aeron® Chairs
56% elastomeric
44% polyester
23101 Mineral
23102 Carbon
23103 Graphite

AireWeave™ 2
For Mirra® 2 Chairs
67% elastomeric
33% antimony-free polyester
1A701 Alpine
1A702 Slate Grey
1A703 Graphite
1A704 Lime Green
1A705 Cappuccino
1A706 Urban Orange
1A707 Dark Turquoise
1A708 Twilight

ColorGuard
54" wide
100% vinyl
3P01 Grey
3P02 Navy *
3P03 Spruce * A
3P08 Blueberry A
3P12 Black Plum A
3P14 Black *
3P19 Slate *
3P31 Horizon Blue A
3P33 Pumice
3P54 Candy Apple A
3P72 Allspice A
3P96 Manzanita A
3P97 Fudge A
3PB2 Sea Grass A
3PB5 Vizcaya Palm A
3PB9 Neptune A
3PC7 Bucksuede * A
3PD4 Otter A

* Colors available on Eames®
Tandem Sling Seating.
A Assigned lead-time color.

Crossing
54" wide
86% antimony-free polyester
14% polyester
8T03 Wicker
8T04 Porcelain
8T05 Warm Grey
8T06 Sepia
8T07 Pumpkin
8T08 Copper
8T09 Cranberry
8T10 Tomato
8T11 Mulberry
8T12 Plum
8T13 Green Apple
8T14 Loden
8T15 Spruce
8T16 Periwinkle
8T17 Cerulean
8T18 Indigo
8T19 Shale
8T20 Brownstone
8T21 Bark
8T22 Tin
8T23 Graphite
8T24 Black

Dex
54" wide
50% recycled polyester
50% polyester
3DE01 Frost
3DE02 Silver Pine
3DE03 Stone
3DE04 Shale
3DE05 Charcoal

Duo
For Lino™ Chairs
52% polyester
48% elastomeric
4RM01 Mineral
4RM02 Poppy
4RM03 Green Leaf
4RM04 Jade
4RM05 Shadow
4RM06 Graphite

Flexnet™
For Caper® Chairs
69% elastomeric
31% polyester
6V01 Black
6V02 Silver Grey

Gem
54" wide
100% antimony-free polyester
9501 Sesame
9502 Tangerine
9503 Red
9504 Red Violet
9505 Mulberry
9506 Java
9507 Twilight
9508 Bayou
9509 Iris
9510 Berry Blue
9511 Aqua Green
9512 Green Apple
9513 Spruce
9514 Black
9515 Slate Grey
9516 Fog

Intercept
For Cosm™ Chairs
60% elastomeric
40% polyester
84501 Graphite
84502 Carbon
84503 Mineral
84504 Nightfall
84505 Glacier
84506 Canyon

Interweave
For Verus™ Chairs
71% elastomeric
29% polyester
6504 Pewter
6505 Charcoal
6506 Black

Price category 1 continued on
next page

Proprietary Textile Colors — Seating

continued

Price Category 1

continued

Lyris 2™

For Setu® Chairs

74% elastomeric

26% polyester

4W21 Alpine

4W22 Mango

4W23 Chartreuse

4W25 Berry Blue

4W26 Slate Grey

4W28 Chino

4W29 Rattan

4W30 Java

4W31 Graphite

Monologue

54" wide

56% recycled polyester

44% polyester

1MN01 Linen

1MN02 Alabaster

1MN03 Truffle

1MN04 Folkstone

1MN05 Silver Pine

1MN06 Slate

1MN07 Seed

1MN08 Yellow Oxide

1MN09 Persimmon

1MN10 Tundra

1MN11 Meadow

1MN12 Blue Sky

1MN13 Blue Spruce

1MN14 Deep Sea

Stretch Knit

Assigned lead-time textile. A

Available only on Sayl®

Suspension Back Work Chairs

97% polyester, 3% spandex

3DK01 Fog

3DK02 Slate Grey

3DK03 Java

3DK04 Black

3DK05 Red

3DK06 Green Apple

3DK07 Berry Blue

Tailored

Assigned lead-time textile. A

54" wide

56% polyester

44% recycled polyester

23501 Studio White *

23502 Sugar *

23503 Tomato

23504 Orchid

23505 Boysenberry

23506 Chive

23507 Bluegrass

23508 Cobalt

23509 Cadet

23510 Fog

23511 Graphite

23512 Black

23513 Coffee

* Colors not available on Plex™
Lounge Furniture.

Whisper

54" wide

73% recycled polyester

27% polyester

1WS01 Sand Dollar

1WS02 Pebble

1WS03 Silver Birch

1WS04 Iceberg

1WS05 Silver Pine

1WS06 Carbon

1WS07 Cumin

1WS08 Adobe

1WS09 Strawberry

1WS10 Blush

1WS11 Eggplant

1WS12 Willow

1WS13 Sea Grass

1WS14 Pool

1WS15 Blueberry

Price Category 2

Aristo

54" wide

88% recycled polyester

12% polyester

Acrylic backing

3AR01 Forest Moss

3AR02 Light Brindle

3AR03 Mink

3AR04 Copper

3AR05 Adobe

3AR06 Cherry

3AR07 Lilac

3AR08 Green Apple

3AR09 Surf

3AR10 Waterfall

3AR11 Cadet

3AR12 Tin

3AR13 Pewter

3AR14 Grey Brindle

3AR15 Grey Black

Crepe

54" wide

100% recycled polyester

9201 Licorice

9203 Smoke

9207 Cherry

9209 Claret

9212 Raisin

9218 Aquamarine

9223 Cadet

9241 Beachglass

9243 Midnight

9244 Artichoke

9248 Warm White

9249 Stone

9250 Earth

9251 Fog

9252 Slate Grey

9253 Yellow Dark

9254 Coral

9255 Blush Grey

9256 Wild Berry

9257 Clover

9258 Caribbean

9259 Cerulean

Crepe continued

9260 Brownstone

9261 Shale

9262 Graphite

9263 Tomato

9264 Green Apple

Epic

54" wide

56% recycled polyester

44% polyester

Acrylic backing

3EP01 Alabaster

3EP02 Smoke

3EP03 Falcon

3EP04 Citrus Spring

3EP05 Copper

3EP06 Urban Orange

3EP07 Poppy

3EP08 Wild Plum

3EP09 Sugar Plum

3EP10 Clover

3EP11 Loden

3EP12 Everglade

3EP13 Mist

3EP14 Peacock

3EP15 Cadet

3EP16 Indigo

3EP17 Spring Wood

3EP18 Grey Brindle

3EP19 Seed

3EP20 Carbon Dark

Price category 2 continued on
next page

Proprietary Textile Colors — Seating

continued

Price Category 2

continued

Fish Net

55" wide	
100% recycled polyester	
22Q01	Oyster
22Q02	Stone
22Q03	Citrus
22Q04	Curry
22Q05	Chipotle
22Q06	Cherry
22Q07	Fuschia
22Q08	Claret
22Q09	Purple
22Q10	Clover
22Q11	Pesto
22Q12	Peacock
22Q13	Lagoon
22Q14	Twilight
22Q15	Bluestone
22Q16	Storm
22Q17	Black
22Q18	Cocoa

Loom

54" wide	
100% polyester	
1LM01	Linen
1LM02	Brown Sugar and Spice
1LM03	Brick and Mortar
1LM04	Salt and Pepper
1LM05	Black
1LM06	Lemongrass
1LM07	Poppy
1LM08	Wild Berry
1LM09	Loden
1LM10	Jade
1LM11	Deep Sea

Marvel

54" wide	
100% pvc-free polyurethane	
1MV01	Summer White
1MV02	Sand Dollar
1MV03	Espresso
1MV04	Folkstone Grey
1MV05	Graphite
1MV06	Onyx
1MV07	Polar Blue
1MV08	Blush Grey
1MV09	Woodrose
1MV10	Citrus
1MV11	Adobe
1MV12	Red
1MV13	Kiwi Green
1MV14	Pine
1MV15	Teal Green
1MV16	Twilight

Medley

54" wide	
100% polyester	
1HA01	Stone
1HA02	Trail
1HA03	Charcoal
1HA04	Cinder
1HA05	Citrus
1HA06	Papaya
1HA07	Chutney
1HA08	Tundra
1HA09	Feather Grey
1HA10	Chartreuse
1HA11	Loden
1HA12	Peacock
1HA13	Bayou
1HA14	Blue Grotto
1HA15	Blueberry
1HA22	Khaki
1HA23	Pewter
1HA24	Yellow Oxide
1HA25	Vintage Rose
1HA26	Raspberry
1HA27	Acai Berry

Moiré

54" wide	
100% recycled polyester	
3A01	Concrete
3A02	Biscotti
3A03	Rattan
3A04	Chambray
3A05	Fern
3A08	Violet
3A09	Zin
3A10	Curry
3A11	Spice
3A12	Cork

Rhythm

54" wide	
100% polyester	
3001	Kiwi Green *
3002	Green Apple
3003	Peacock
3004	Bayou *
3005	Berry Blue
3006	Iris
3007	Twilight
3008	Pumpkin *
3009	Poppy *
3010	Molasses
3011	Mulberry
3012	Khaki *
3013	Mink
3014	Black
3015	Charcoal

* Colors not available on Embody® Chair.

Rivet

54" wide	
100% recycled polyester	
1RV01	Twig
1RV02	Deep Clay
1RV03	Woodrose
1RV04	Otter
1RV05	Hemlock
1RV06	Olive
1RV07	Lagoon
1RV08	Deep Sea
1RV09	Charcoal
1RV10	Grey Brindle

Twist

54" wide	
80% antimony-free polyester	
13% recycled polyester	
7% polyester	
8R05	Wicker
8R10	Poppy
8R14	Tin
8R15	Shale
8R16	Graphite
8R17	Birch
8R18	Sepia
8R22	Blueberry
8R23	Green Apple
8R26	Gunmetal
8R27	Cinder
8R28	Citrus
8R29	Pekoe
8R30	Tangerine
8R31	Red Plum
8R32	Wisteria
8R33	Forest
8R34	Jade Dark
8R35	Waterfall
8R36	Midnight Blue
8R37	Carbon Dark

Price category 2 continued on next page

Proprietary Textile Colors — Seating

continued

Price Category 2

continued

Well Suited

55" wide
79% polyester
21% recycled polyester

22T01	Oyster *
22T02	Raffia *
22T03	Peppermint *
22T04	Wild Berry *
22T05	Spring Green *
22T06	Mint *
22T07	Periwinkle *
22T08	Cool Grey *
22T09	Citrus *
22T10	Pumpkin
22T11	Red
22T12	Fuschia
22T13	Orchid
22T14	Chartreuse *
22T15	Green Apple
22T16	Jade
22T17	Peacock
22T18	Blueberry
22T19	Bluestone *
22T20	Mink

* Colors not available on Swoop™ Plywood Lounge Seating.

Price Category 3

Ace

54" wide
100% polyurethane
Polyester knit backing
Stain resistant finish

3AC01	Summer White
3AC02	White Ash
3AC03	Rye
3AC04	Metal
3AC05	Clay
3AC06	Chestnut
3AC07	Citrus
3AC08	Camelback
3AC09	Chipotle
3AC10	Claret
3AC11	Slate Purple
3AC12	Artichoke
3AC13	Sepia Dark
3AC14	Aloe
3AC15	Flint
3AC16	Blue Sky
3AC17	Oceanside
3AC18	Midnight
3AC19	Spring Wood
3AC20	Frost
3AC21	Lead
3AC22	Black

Bento

54" wide
100% antimony-free polyester

7001	Frost
7002	Linen
7003	Khaki
7004	Truffle
7005	Grey Black
7006	Pumpkin
7007	Cranberry
7008	Everglade
7009	Cobalt

Latitude™

61" wide
100% polyester

8M01	Graphite
8M02	Shadow
8M10	Alpine
8M17	Black
8M21	Slate Grey
8M22	Lime Green
8M23	French Press
8M24	Urban Orange
8M25	Dark Turquoise
8M26	Twilight

Latitude

Colors for Mirra 2 Chairs
100% polyester

8M10	Alpine
8M17	Black
8M21	Slate Grey
8M22	Lime Green
8M23	French Press
8M24	Urban Orange
8M25	Dark Turquoise
8M26	Twilight

Pins and Needles

58" wide
76% recycled polyester
24% polyester

22R01	Day and Night
22R02	Night and Day

Stitches

54" wide
54% polyester
46% recycled polyester

8U02	Rye
8U03	Khaki
8U04	Honey
8U05	Cattail
8U08	Cool Grey
8U09	Slate Blue
8U11	Evening Blue
8U12	Charcoal
8U13	Kiwi Green
8U16	Cocoa
8U17	Seed

String Plaid

54" wide
100% recycled polyester

22V01	Warm White on Khaki
22V02	Mint on Yellow Green
22V03	Mist on Blue Grey
22V04	Sky Blue on Red
22V05	Lime on Magenta
22V06	Bright Green on Green
22V07	Aqua Blue on Cerulean
22V08	Ivory on Black

Proprietary Textile Colors — Seating

continued

Price Category 4

Bingo

54" wide
100% PVC-free polyurethane
Resilience® finish

7Y01	Oyster
7Y02	Natural
7Y03	Cashew
7Y05	Rattan
7Y06	Root
7Y07	Woodland
7Y10	Allspice
7Y11	Canyon
7Y17	Seed
7Y18	Mushroom
7Y19	Blue Grey
7Y21	Black
7Y22	Mint
7Y23	Seaport
7Y24	Evening Blue
7Y26	Kiwi Green
7Y27	Celadon
7Y29	Pesto

Dialogue

For Public Office Landscape®
Sectional Back/Social Chair Back
knit to size
100% polyester

1DL01	Light Brindle
1DL02	Dark Brindle

Mercer

54" wide
50% solution dyed recycled nylon
50% solution dyed nylon
BLOCKaide

21301	Stone
21303	Cayenne
21305	Pesto
21306	Teal Blue
21307	Ultramarine
21310	Charcoal

Network

For Public Office Landscape®
Sectional Back/Social Chair Back
knit to size
100% polyester

1A901	Warm White
1A902	Fog
1A903	Red
1A904	Wildberry
1A905	Green Apple
1A906	Twilight
1A907	Graphite

Plateau

Perspectives® Collection

knit to size
100% polyester

6J01	Feather Grey
6J02	Trail
6J06	Twig
6J08	Sagebrush
6J09	Winter Berry
6J10	Thunder
6J11	Blueberry
6J12	Rosemary
6J14	Black

Quilty

56" wide
100% antimony-free polyester
GreenShield

6S03	Khaki
6S04	Straw
6S07	Brick
6S10	Mink
6S11	Green Apple
6S13	Indigo
6S14	Zinc
6S15	Slate
6S16	Beachwood
6S17	Paprika
6S18	Plum
6S19	Juniper
6S20	Grey Black

Spools

54" wide
51% recycled polyester
49% polyester
Crypton® Green

8Y03	Trail
8Y05	Copper
8Y08	Bluegrass
8Y09	Lagoon
8Y11	Beachglass
8Y12	Marsh
8Y13	Bud

Strata

54" wide
50% solution dyed recycled nylon
50% solution dyed nylon
BLOCKaide

22P04	Pesto
22P05	Peacock
22P06	Blue Jay
22P07	Blueberry
22P09	Mango
22P10	Paprika
22P12	Wheat
22P13	Brownstone
22P14	Bayou

Price Category 5

Hopsak

56" wide
100% recycled polyester

14A20	Black
14A22	Raw Umber Dark
14A26	Grey Blue Dark
14A30	Sepia Dark
14A38	Emerald Dark
14A39	Yellow Dark
14A40	Orange
14A41	Sienna
14A42	Olive Green Dark
14A43	Crimson
14A44	Crimson Dark Dark
14A45	Violet Dark
14A46	Pink Dark Dark
14A47	Ultramarine Dark
14A48	Cobalt Blue
14A49	Terra Cotta
14A50	Ochre Dark

Noble

Assigned lead-time textile. ^A

54" wide 100% wool	
22N02	Chipotle *
22N04	Cherry *
22N07	Cadet *
22N08	Berry Blue *
22N09	Peacock *
22N11	Pesto *
22N12	Blue Grey Mix *
22H15	Heathered Black **
22H16	Heathered Grey **
22H17	Heathered Twilight **
22H18	Heathered Rye Grass **
22N19	Lemongrass Mix *
22H20	Heathered Red **
22H21	Heathered Wild Berry **
22N22	Pesto Mix *
22N23	Lagoon Mix *

* Colors not available on Sayl® Side Chairs.

** Colors not available on Sayl Side Chairs Back.

Proprietary Textile Colors — Seating

continued

Appendix: Proprietary Textile Colors | Seating

Price Category 6

Balance	
For Embody® chairs	
100% polyester	
3506	Green Apple
3507	Blue Moon
3509	Berry Blue
3510	Iris
3512	Carbon
3513	Black

Price Category 7

Customer's Own Leather
See Order Information in Appendices. Assigned lead-time textile. A

Price Category 8

No fabrics available at this time.

Price Category 9

Leather	
approx. 50 sq. ft. per hide	
100% leather	
2101	Ivory
2109	Black *
2110	Smoke
2111	Graphite
2112	Khaki
2113	Rattan
2114	Truffle
2115	Alpine
2116	Haze
2117	Sable Grey
2118	Dark Mineral **
2119	Dark Carbon ***
2120	Cranberry
2121	Deep Sea

* Armpad color available on Aeron® Chair, Graphite.

** Armpad color available on Aeron Chair, Mineral.

*** Armpad color available on Aeron Chair, Carbon.

Maharam® Application Chart — Seating

- Available

See below for exception notes.

Maharam textiles are on assigned lead times. A

[N] Non-woven textile.

	Mirra® Chairs/Stools	Celle® Chairs	Sayl® Work Chairs/Stools	Sayl® Side Chairs	Setu® Chairs/Stools	Setu Lounge Chair/Ottoman	Verus™ Work Chairs/Stools Back	Verus Work Chairs/Stools Seat	Verus Side Chairs Back	Verus Side Chairs Seat	Equa 2® Fully Upholstered Chairs/Stools	Equa 2 Split-Pad Upholstered Chairs/Stools	Aside® Chairs	Caper® Chairs/Stools	Celeste™ Seating	Keyn Chair Group Back	Keyn Chair Group Seat	Lino™ Chairs Seat	Locale® Bench Cushions	Public Office Landscape® Seat	Plex™ Lounge Furniture	Swoop™ Lounge Seating - Fully Upholstered	Swoop Lounge Seating - Plywood	Cushion Tops	Workspaces	
Price Category 1-2																										
No fabrics available at this time.																										
Price Category 3																										
ZM2__ Meld - Maharam		14	•	•	•	•	•	•	•	•	•	•	8				•		•	•	•	•	•	•	•	•
Price Category 4-9																										
No fabrics available at this time.																										
Price Category A																										
No fabrics available at this time.																										
Price Category B																										
VM__ Medium - Maharam		14	•	•			•	•		•	•	3	•		•	•	•	•			•	•	•	•	•	•
TI__ Messenger - Maharam *		14	•	•	•	•	•	•	•	•		•	•		•	•	•	•			•	•	•	•	•	•
Price Category C																										
ZLR__ Lariat - Maharam [N]		14	•	•			•	•		•						•	•			•	20			•		
Z27__ Manner - Maharam		14	•	•			•		•	•	•	•			•	•	•	•			•	•	•	•	•	
Z3__ Metric - Maharam		14	•	•			•	•	•	•	•	•			•	•	•	•			•	•	•	•	•	
Price Category D																										
ZMD__ Mode - Maharam		14	18	•			•	•		•	•						•		•		•	•	•	•	•	
Price Category E																										
ZFS__ Focus - Maharam		14	16	16								•					•								•	
VgG__ Ledger - Maharam [N]		14	18	16			•	•		•						•	•	•							•	
ZBQ__ Oblique - Maharam				16			•		•			•					•					•	•	•		
ZP2__ Pick - Maharam				18	•			•		•							•	•				•	•	•		
Z32__ Skein - Maharam		14	16	16	•							•					•								•	
ZT3__ Technic - Maharam		14	18	•								•					•									
Price Category F																										
ZCH__ Chock - Maharam					•								•													
ZC8__ Coin - Maharam		14	•	16									•				•								•	
ZCJ__ Coincide - Maharam				16	•												•								•	
VS__ Crush - Maharam						•	•									•						•			•	
ZD1__ Disc - Maharam		14	18	16								•					•	•							•	
ZD3__ Divide - Maharam		14	18	•								•					•								•	
ZEE__ Exchange - Maharam		14	18	16				•		•		•					•	•			20				•	
Z29__ Plait - Maharam		14		16	•		•	•		•						•	•					•	•	•	•	
V26__ Remix - Maharam				16	16											•	•	•			•		•	•	•	
ZRV__ Rove - Maharam		14	16	•				•		•							•	•								
ZRA__ Runner Standard - Maharam		14	18	•													•									
ZSM__ Seam - Maharam		14	•	•									•				•	•								
Z31__ Sequence - Maharam		14	•	•			•				•	•				•	•					•			•	
ZSS__ Shuttle Standard - Maharam		14	•	•													•									
Z33__ Strum - Maharam [N]				16												•	•					•				

* Available in select colors on 20-day lead-time.
Refer to "Maharam Colors - Seating" for 20-day colors.

continued on next page

Maharam® Application Chart — Seating *continued*

- Available

See below for exception notes.

Maharam textiles are on assigned lead times. A

[N] Non-woven textile.

Mirra® Chairs/Stools	Celle® Chairs	Sayl® Work Chairs/Stools	Sayl Side Chairs	Setu® Chairs/Stools	Setu Lounge Chair/Ottoman	Verus™ Work Chairs/Stools Back	Verus Work Chairs/Stools Seat	Verus Side Chairs Back	Verus Side Chairs Seat	Equa 2® Fully Upholstered Chairs/Stools	Equa 2 Split-Pad Upholstered Chairs/Stools	Aside® Chairs	Caper® Chairs/Stools	Celeste™ Seating	Keyn Chair Group Back	Keyn Chair Group Seat	Lino™ Chairs Seat	Locale® Bench Cushions	Public Office Landscape® Seat	Plex™ Lounge Furniture	Swoop™ Lounge Seating - Fully Upholstered	Swoop Lounge Seating - Plywood	Cushion Tops	Workspaces
----------------------	---------------	--------------------------	------------------	---------------------	---------------------------	--------------------------------	-------------------------------	------------------------	------------------------	---	--	---------------	----------------------	------------------	-----------------------	-----------------------	-------------------	------------------------	-------------------------------	------------------------	---	--------------------------------	--------------	------------

Price Category G

ZC9__ Coin Crypton - Maharam			• 16				•										•							
ZCF__ Coincide High Performance - Maharam	14	16	16				•		•								•							
ZCQ__ Colline - Maharam																								
ZC2__ Compound - Maharam [N]			16	16			•		•			• 8					•	•		•		•		
ZD2__ Disc Crypton - Maharam	14	16	16														•							
ZD4__ Divide Crypton - Maharam	14	16	•									•					•							
Z23__ Divina MD - Maharam	14	• 16	•		•	•	•	•	•	•	•			•	•	•	•			•		•	•	
TF__ Divina - Maharam	14	•	•	•	•	•	•	•	•	•	•	8		•	•	•	•			•	•	•	•	
TG__ Divina Melange - Maharam	14	•	•	•	•	•	•	•	•	•	•	8		•	•	•	•			•	•	•	•	
ZEM__ Emboss - Maharam [N]	14	16															•							
ZF1__ Fold - Maharam [N]	14	16	16														•							
ZH1__ Hero by Kvadrat - Maharam	14	• 16			•	•	•	•				•			•	•	•							
ZQM__ Omen - Maharam	14	18	16									•					•							
ZP1__ Pick Crypton - Maharam	14	16	•									•					•	•						
ZP3__ Pocket - Maharam	14		•				•		•			•					•	•			•		•	
ZRG__ Ring - Maharam	14	16	16														•							
ZRF__ Runner - Maharam	14	16	16														•						•	
ZSN__ Sheen - Maharam	14	18	•			•	•		•			•					•							
ZSE__ Steelcut - Maharam			•	•			•	•	•								•	•		•				
V25__ Steelcut Trio - Maharam	14	16	•					•						•		•				•			•	
ZS1__ Stride - Maharam	14	•	•									•					•	•						
ZT4__ Ticker - Maharam	14	•	•				•		•			•					•	•					•	•
ZVT__ Vestige - Maharam	14	18	•									•					•	•						

Price Category H

ZT__ Circles - Maharam	14	16	16														•	•						•
ZS__ Crosspatch - Maharam	14		•														•	•						•
Z2D__ Ditto - Maharam	14	• 16															•	•			•		•	
ZK__ Dot Pattern - Maharam	14	•	•	•	•		•		•	•	•	•					•	•						•
Z24__ Hallingdal - Maharam	14	•	•	•		•	•	•	•	•							•	•	•		•		•	
ZQF__ Offset - Maharam	14	16	•									•					•	•						•
ZL__ Small Dot Pattern - Maharam	14	•	•	•	•		•		•	•	•	•					•	•						•
ZTN__ Tonus - Maharam			16	16													•			•				

Price Category I

ZLC__ Latch - Maharam	14	•	•				•		•			•					•							
ZT2__ Teatro - Maharam			•	•			•		•															

Price Category J

ZT1__ Tokyo - Maharam																					•			
-----------------------	--	--	--	--	--	--	--	--	--	--	--	--	--	--	--	--	--	--	--	--	---	--	--	--

Price Category K

ZC7__ Coda by Kvadrat - Maharam	14	16	16									•											•	•
---------------------------------	----	----	----	--	--	--	--	--	--	--	--	---	--	--	--	--	--	--	--	--	--	--	---	---

Price Category L

ZMK__ Minicheck - Maharam	14	•	•									•					•	•						
---------------------------	----	---	---	--	--	--	--	--	--	--	--	---	--	--	--	--	---	---	--	--	--	--	--	--

Price Category M

ZF2__ Fruit - Maharam	14		16									•												
-----------------------	----	--	----	--	--	--	--	--	--	--	--	---	--	--	--	--	--	--	--	--	--	--	--	--

Price Category N-Z

No fabrics available at this time.																									
------------------------------------	--	--	--	--	--	--	--	--	--	--	--	--	--	--	--	--	--	--	--	--	--	--	--	--	--

- 3 Available on A- and B-size Equa 2 split-pad upholstered chairs.
- 8 Only available on nonupholstered outer back option (PB).
- 14 Available on Celle UC (upholstered seat) and HC (upholstered seat with protective edge) chairs.
- 16 Available on Sayl Chair seat.

- 18 Available on Sayl Chair seat and upholstered mid-back.
- 20 Not available on Plex Club Chair with Headrest.

Maharam® Colors — Seating

Price Category 1-2

No fabrics available at this time.

Price Category 3

Meld – Maharam

54" wide
 68% post-consumer recycled polyester
 32% polyester
 PFOA-Free stain resistant

ZM201/466387-201 Vast
 ZM202/466387-202 Panda
 ZM203/466387-203 Skyline
 ZM204/466387-204 Knight
 ZM205/466387-205 Quill
 ZM206/466387-206 Pipe
 ZM207/466387-207 Grate
 ZM208/466387-208 Gloss
 ZM209/466387-209 Bulb
 ZM210/466387-210 Bride
 ZM211/466387-211 Stark
 ZM212/466387-212 Seashell
 ZM213/466387-213 Antler
 ZM214/466387-214 Crater
 ZM215/466387-215 Perennial
 ZM216/466387-216 Mulberry
 ZM217/466387-217 Fuchsia
 ZM218/466387-218 Amethyst
 ZM219/466387-219 Merlot
 ZM220/466387-220 Magma
 ZM221/466387-221 Rooster
 ZM222/466387-222 Heat
 ZM223/466387-223 Clementine
 ZM224/466387-224 Fox
 ZM225/466387-225 Kiss
 ZM226/466387-226 Bare
 ZM227/466387-227 Blonde
 ZM228/466387-228 Mimosa
 ZM229/466387-229 Comet
 ZM230/466387-230 Honeydew
 ZM231/466387-231 Wild
 ZM232/466387-232 Vine
 ZM233/466387-233 Seed
 ZM234/466387-234 Kale

Meld continued

ZM235/466387-235 Waterfall
 ZM236/466387-236 Nordic
 ZM237/466387-237 Reef
 ZM238/466387-238 Wave
 ZM239/466387-239 Isle
 ZM240/466387-240 Creek
 ZM241/466387-241 Mariner
 ZM242/466387-242 Globe
 ZM243/466387-243 Spa

Price Category 4-9

No fabrics available at this time.

- Maharam textiles are on assigned lead times A unless otherwise noted.
- Fabric numbers are listed as Herman Miller fabric number/Maharam fabric number.

Maharam® Colors — Seating

continued

Price Category A

No fabrics available at this time.

Price Category B

Medium – Maharam

54" wide

100% polyester

VM01/463490-001	Raven
VM02/463490-002	Smoke
VM03/463490-003	Alloy
VM04/463490-004	Flax
VM06/463490-006	Bark
VM07/463490-007	Espresso
VM08/463490-008	Pecan
VM12/463490-012	Pumpkin
VM13/463490-013	Persimmon
VM14/463490-014	Laser
VM16/463490-016	Port
VM22/463490-022	Marina
VM29/463490-029	Pistachio
VM32/463490-032	Prospect
VM36/463490-036	Delight
VM39/463490-039	Nautical
VM40/463490-040	Pool
VM44/463490-044	Washed
VM45/463490-045	Sculpture
VM46/463490-046	Thatched
VM47/463490-047	Hike
VM48/463490-048	Tangle
VM49/463490-049	Pacific
VM50/463490-050	Cosmic
VM51/463490-051	Cascade
VM52/463490-052	Blackberry
VM53/463490-053	Nasturtium
VM54/463490-054	Wooded

Messenger – Maharam

54" wide

78% recycled polyester

15% polyester, 7% nylon

TI01/458640-001	Balsa
TI06/458640-006	Tobacco
TI07/458640-007	Shadow *
TI08/458640-008	Bayou *
TI10/458640-010	Zinc
TI24/458640-024	Poppy
TI25/458640-025	Mao
TI29/458640-029	Onyx
TI31/458640-031	Cloud *
TI38/458640-038	Depth *
TI40/458640-040	Nile
TI41/458640-041	Azure *
TI45/458640-045	Cactus *
TI46/458640-046	Ice *
TI48/458640-048	Neon *
TI50/458640-050	Hydrangea *
TI51/458640-051	Lilac
TI52/458640-052	Chestnut
TI53/458640-053	Tangelo
TI54/458640-054	Lumine *
TI58/458640-058	Snow
TI59/458640-059	Fennel
TI60/458640-060	Peridot *
TI61/458640-061	Capri
TI62/458640-062	Ultramarine
TI63/458640-063	Squall
TI66/458640-066	Cassis
TI67/458640-067	Aster
TI68/458640-068	Spice
TI69/458640-069	Cherry
TI70/458640-070	Vibrant
TI71/458640-071	Satsuma *
TI72/458640-072	Maize

Messenger continued

TI76/458640-076	Fossil
TI77/458640-077	Ash
TI78/458640-078	Tusk
TI79/458640-079	Oyster
TI80/458640-080	Pensive
TI81/458640-081	Husk
TI82/458640-082	Fireside
TI83/458640-083	Chili
TI84/458640-084	Robust
TI85/458640-085	Beyond
TI86/458640-086	Voyage
TI87/458640-087	Everglade
TI88/458640-088	Electric

* Colors available on 20-day lead time.

- Maharam textiles are on assigned lead times A unless otherwise noted.
- Fabric numbers are listed as Herman Miller fabric number/Maharam fabric number.

Maharam® Colors — Seating

continued

Price Category C

Lariat – Maharam	
54" wide	
100% vinyl	
ZLR01/440401-001	001
ZLR02/440401-002	002
ZLR03/440401-003	003
ZLR04/440401-004	004
ZLR06/440401-006	006
ZLR07/440401-007	007
ZLR08/440401-008	008
ZLR10/440401-010	010
ZLR11/440401-011	011
ZLR12/440401-012	012
ZLR13/440401-013	013
ZLR14/440401-014	014
ZLR15/440401-015	015
ZLR16/440401-016	016
ZLR18/440401-018	018
ZLR20/440401-020	020
ZLR21/440401-021	021
ZLR23/440401-023	023
ZLR24/440401-024	024
ZLR25/440401-025	025
ZLR26/440401-026	026
ZLR27/440401-027	027
ZLR28/440401-028	028
ZLR29/440401-029	029
ZLR30/440401-030	030
ZLR31/440401-031	031
ZLR32/440401-032	032
ZLR33/440401-033	033
ZLR34/440401-034	034
ZLR35/440401-035	035
ZLR36/440401-036	036
ZLR37/440401-037	037
ZLR38/440401-038	038

Manner - Maharam	
54" wide	
100% recycled polyester	
Z2701/466177-001	Magic
Z2702/466177-002	Carob
Z2703/466177-003	Porpoise
Z2704/466177-004	Flint
Z2705/466177-005	Hush
Z2706/466177-006	Nuance
Z2707/466177-007	Thicket
Z2708/466177-008	Cocoa
Z2709/466177-009	Pathway
Z2710/466177-010	Cola
Z2711/466177-011	Ember
Z2712/466177-012	Wagon
Z2713/466177-013	Ablaze
Z2714/466177-014	Peel
Z2715/466177-015	Penny
Z2716/466177-016	Butterscotch
Z2717/466177-017	Harvest
Z2718/466177-018	Lioness
Z2719/466177-019	Caper
Z2720/466177-020	Parakeet
Z2721/466177-021	Greenway
Z2722/466177-022	Aquatic
Z2723/466177-023	Cottage
Z2724/466177-024	Dahlia
Z2725/466177-025	Vivid
Z2726/466177-026	Basin
Z2727/466177-027	Schooner

Metric – Maharam	
54" wide	
51% recycled polyester	
49% polyester	
Z301/466014-001	Phantom
Z302/466014-002	Fog
Z303/466014-003	Fleece
Z304/466014-004	Sourdough
Z305/466014-005	Toffee
Z306/466014-006	Driftwood
Z307/466014-007	Mineral
Z308/466014-008	Bittersweet
Z309/466014-009	Arabica
Z310/466014-010	Cerise
Z311/466014-011	Brick
Z312/466014-012	Cardinal
Z313/466014-013	Lava
Z314/466014-014	Oriole
Z315/466014-015	Cedar
Z317/466014-017	Caramel
Z318/466014-018	Pollen
Z319/466014-019	Tupelo
Z320/466014-020	Alligator
Z321/466014-021	Envy
Z322/466014-022	Bonsai
Z323/466014-023	Tar
Z324/466014-024	Anchor
Z325/466014-025	Twilight
Z326/466014-026	Admiral
Z327/466014-027	Seaport
Z328/466014-028	Scuba

Price Category D

Mode – Maharam	
54" wide	
80% post-consumer recycled polyester	
20% polyester	
PFOA-Free stain resistant finish	
ZMD01/466337-001	Stroll
ZMD02/466337-002	Intaglio
ZMD03/466337-003	Ominous
ZMD04/466337-004	Machine
ZMD05/466337-005	Talus
ZMD06/466337-006	Marsh
ZMD07/466337-007	Hollow
ZMD08/466337-008	Sycamore
ZMD09/466337-009	Clavicle
ZMD10/466337-010	Billygoat
ZMD11/466337-011	Spindle
ZMD12/466337-012	Lemon
ZMD13/466337-013	Oxeye
ZMD14/466337-014	Henge
ZMD15/466337-015	Goldenrod
ZMD16/466337-016	Cottontail
ZMD17/466337-017	Lioness
ZMD18/466337-018	Oriole
ZMD19/466337-019	Rust
ZMD20/466337-020	Carotene
ZMD21/466337-021	Blush
ZMD22/466337-022	Vermillion
ZMD23/466337-023	Alder
ZMD24/466337-024	Kermes
ZMD25/466337-025	Barberry
ZMD26/466337-026	Petal
ZMD27/466337-027	Valley
ZMD28/466337-028	Odyssey
ZMD29/466337-029	Ballpoint
ZMD30/466337-030	Toile
ZMD31/466337-031	Paradise
ZMD32/466337-032	Angelfish
ZMD33/466337-033	Denim

Price category D continued on next page

- Maharam textiles are on assigned lead times **A** unless otherwise noted.
- Fabric numbers are listed as Herman Miller fabric number/Maharam fabric number.

Maharam® Colors — Seating

continued

Price Category D

continued

Mode continued

ZMD34/466337-034	Crush
ZMD35/466337-035	Jetty
ZMD36/466337-036	Saltwater
ZMD37/466337-037	Mallard
ZMD38/466337-038	Celtic
ZMD39/466337-039	Eucalyptus
ZMD40/466337-040	Bonsai
ZMD41/466337-041	Sassafras
ZMD42/466337-042	Yucca
ZMD43/466337-043	Lichen

Focus - Maharam

57" wide	
54% post-industrial recycled polyester	
33% polyester	
13% post-consumer recycled polyester	
ZFS01/465910-001	Ivory
ZFS02/465910-002	Allow
ZFS04/465910-004	Lichen
ZFS06/465910-006	Sierra
ZFS07/465910-007	Merlot
ZFS08/465910-008	Clove
ZFS09/465910-009	Carbon
ZFS10/465910-010	Regatta
ZFS11/465910-011	Emerald

Ledger – Maharam

54" wide	
100% polyurethane	
V9G1/463770-001	001
V9G2/463770-002	002
V9G3/463770-003	003
V9G4/463770-004	004
V9G6/463770-006	006
V9G7/463770-007	007
V9GG/463770-017	017
V9GH/463770-018	018
V9GJ/463770-019	019
V9GM/463770-022	022
V9GQ/463770-025	025
V9GS/463770-026	026
V9GU/463770-028	028
V9GV/463770-029	029
V9GW/463770-030	030
V9GX/463770-031	031
V9GY/463770-032	032
V9GZ/463770-033	033
V9G10/463770-034	034
V9G11/463770-035	035
V9G12/463770-036	036
V9G13/463770-037	037
V9G14/463770-038	038

V9G14/463770-038 038

Ledger continued

V9G15/463770-039	039
V9G16/463770-040	040
V9G17/463770-041	041
V9G18/463770-042	042
V9G19/463770-043	043
V9G20/463770-044	044
V9G21/463770-045	045
V9G22/463770-046	046

Oblique - Maharam

58" wide	
100% polyester	
with stain resistant finish	
ZBQ01/466222-001	001
ZBQ02/466222-002	002
ZBQ03/466222-003	003
ZBQ04/466222-004	004
ZBQ05/466222-005	005
ZBQ06/466222-006	006
ZBQ07/466222-007	007

Pick - Maharam

58" wide	
100% polyester	
with stain resistant finish	
ZP201/466224-001	001
ZP202/466224-002	002
ZP203/466224-003	003
ZP204/466224-004	004
ZP205/466224-005	005
ZP206/466224-006	006
ZP207/466224-007	007
ZP208/466224-008	008
ZP209/466224-009	009
ZP210/466224-010	010

Skein - Maharam

54" wide	
56% recycled polyester	
44% polyester	
Z3201/466170-001	Burrow
Z3204/466170-004	Sumac
Z3205/466170-005	Pomegranate
Z3206/466170-006	Cavern
Z3207/466170-007	Bitter
Z3208/466170-008	Cinder
Z3209/466170-009	Dock
Z3210/466170-010	Cadet
Z3211/466170-011	Marsh

Technic - Maharam

56" wide	
60% post-industrial recycled polyester	
40% post-consumer recycled polyester	
PFOA-Free stain resistant finish	
Acrylic backing	
ZT301/466226-001	Cumin
ZT302/466226-002	Evergreen
ZT303/466226-003	Cobalt
ZT304/466226-004	Bear
ZT305/466226-005	Squirrel

- Maharam textiles are on assigned lead times ^A unless otherwise noted.
- Fabric numbers are listed as Herman Miller fabric number/Maharam fabric number.

Maharam® Colors — Seating

continued

Price Category F

Chock - Maharam	
59" wide	
36% rayon	
35% cotton	
29% solution-dyed post-industrial recycled nylon	
PFOA-Free stain resistant finish	
Acrylic backing	
ZCH01/466219-001	Beige
ZCH02/466219-002	Stone
ZCH03/466219-003	Brown
ZCH04/466219-004	Red
ZCH05/466219-005	Copper
ZCH07/466219-007	Smoke
ZCH08/466219-008	Ebony

Coin - Maharam	
57" wide	
43% polyester	
37% post-industrial recycled polyester	
20% post-consumer recycled polyester	
PFOA-Free stain resistant finish	
Acrylic backing	
ZC801/466233-001	Nickel
ZC802/466233-002	Diner
ZC803/466233-003	Copper
ZC804/466233-004	Maroon
ZC805/466233-005	Penny
ZC806/466233-006	Exchange
ZC807/466233-007	Lead

Coincide - Maharam	
54" wide	
100% polyester	
ZCJ01/465808-001	Mist
ZCJ02/465808-002	Drizzle
ZCJ03/465808-003	Cicada
ZCJ04/465808-004	Bungalow
ZCJ05/465808-005	Aurora
ZCJ06/465808-006	Currant
ZCJ07/465808-007	Raisin
ZCJ08/465808-008	Tranquil
ZCJ09/465808-009	Caribbean
ZCJ10/465808-010	Woodland
ZCJ11/465808-011	Acre

Crush - Maharam	
54" wide	
85% solution-dyed nylon	
13% polyester	
2% polyolefin	
VS01/464780-001	001
VS02/464780-002	002
VS05/464780-005	005
VS08/464780-008	008
VS13/464780-013	013
VS16/464780-016	016
VS17/464780-017	017
VS18/464780-018	018
VS19/464780-019	019
VS20/464780-020	020
VS22/464780-022	022
VS23/464780-023	023
VS26/464780-026	026
VS27/464780-027	027

Disc - Maharam	
57" wide	
100% polyester	
PFOA-Free stain resistant finish	
Acrylic backing	
ZD101/466221-001	Nude
ZD102/466221-002	Khaki
ZD103/466221-003	Festive
ZD104/466221-004	Vibrant
ZD105/466221-005	Somber
ZD106/466221-006	Warm
ZD107/466221-007	Steel

Divide - Maharam	
57" wide	
45% polyester	
36% post-industrial recycled polyester	
19% post-consumer recycled polyester	
PFOA-Free stain resistant finish	
Acrylic backing	
ZD301/466220-001	Ecru
ZD302/466220-002	Café
ZD303/466220-003	Concrete
ZD304/466220-004	Forest
ZD305/466220-005	Tropic
ZD306/466220-006	Lagoon
ZD307/466220-007	Mocha
ZD308/466220-008	Singe
ZD309/466220-009	Cayenne

Exchange - Maharam	
58" wide	
58% post-industrial recycled polyester	
42% post-consumer recycled polyester	
ZEE01/466027-001	Cinder
ZEE02/466027-002	Sable
ZEE04/466027-004	Gull
ZEE06/466027-006	Coastline
ZEE07/466027-007	Clay
ZEE08/466027-008	Buck
ZEE10/466027-010	Rhubarb
ZEE11/466027-011	Punch

Plait - Maharam	
58" wide	
68% recycled polyester	
32% polyester	
Z2901/466052-001	Cobblestone
Z2902/466052-002	Sachet
Z2903/466052-003	Mesa
Z2904/466052-004	Tavern
Z2905/466052-005	Sequoia
Z2906/466052-006	Rhubarb
Z2907/466052-007	Sangria
Z2908/466052-008	Reef
Z2909/466052-009	Stormy
Z2910/466052-010	Dapper

Remix - Maharam	
54" wide	
90% wool	
10% nylon	
V2601/465956-113	113
V2602/465956-123	123
V2603/465956-133	133
V2604/465956-143	143
V2605/465956-152	152
V2606/465956-163	163
V2607/465956-173	173
V2608/465956-183	183
V2609/465956-223	223
V2610/465956-233	233
V2611/465956-242	242
V2612/465956-252	252
V2613/465956-362	362
V2614/465956-373	373
V2615/465956-383	383
V2616/465956-393	393
V2617/465956-412	412
V2618/465956-422	422
V2619/465956-433	433
V2620/465956-443	443
V2621/465956-452	452
V2622/465956-543	543
V2623/465956-612	612

Price category F continued on next page

- Maharam textiles are on assigned lead times ^A unless otherwise noted.
- Fabric numbers are listed as Herman Miller fabric number/Maharam fabric number.

Maharam® Colors — Seating

continued

Price Category F

continued

Remix continued	
V2624/465956-632	632
V2625/465956-643	643
V2626/465956-653	653
V2627/465956-662	662
V2628/465956-672	672
V2629/465956-682	682
V2630/465956-692	692
V2631/465956-722	722
V2632/465956-733	733
V2633/465956-743	743
V2634/465956-753	753
V2635/465956-762	762
V2636/465956-773	773
V2637/465956-783	783
V2638/465956-823	823
V2639/465956-842	842
V2640/465956-852	852
V2641/465956-873	873
V2642/465956-912	912
V2643/465956-923	923
V2644/465956-933	933
V2645/465956-942	942
V2646/465956-962	962
V2647/465956-973	973
V2648/465956-982	982
V2649/465956-954	954

Rove - Maharam	
54" wide	
100% solution-dyed polyolefin with silver-based antimicrobial	
ZRV01/466096-001	Rice
ZRV02/466096-002	Soba
ZRV03/466096-003	Owl
ZRV04/466096-004	Till
ZRV05/466096-005	Dijon
ZRV06/466096-006	Mum
ZRV07/466096-007	Nasturtium
ZRV08/466096-008	Vixen
ZRV09/466096-009	Roast
ZRV10/466096-010	Llama
ZRV11/466096-011	Rind
ZRV12/466096-012	Grackle
ZRV13/466096-013	Indigo
ZRV14/466096-014	Drip
ZRV15/466096-015	Neptunia
ZRV16/466096-016	Pomelo
ZRV17/466096-017	Fairy

Runner Standard - Maharam	
58" wide	
57% post-industrial recycled polyester	
43% post-consumer recycled polyester	
ZRA07/466167-007	Bluff
ZRA08/466167-008	Arid
ZRA09/466167-009	Grove
ZRA10/466167-010	Starboard
ZRA11/466167-011	Plot
ZRA12/466167-012	Carousel

Seam - Maharam	
54" wide	
100% polyester	
PFOA-Free stain resistant finish	
Acrylic backing	
ZSM01/466289-001	Reed
ZSM02/466289-002	Console
ZSM03/466289-003	Play
ZSM04/466289-004	Jock
ZSM05/466289-005	Engine
ZSM06/466289-006	Haunted
ZSM07/466289-007	Transmit
ZSM08/466289-008	Spark
ZSM09/466289-009	Storm
ZSM10/466289-010	Tunnel

Sequence - Maharam	
54" wide	
100% solution-dyed polyolefin with silver-based antimicrobial	
Z3101/466179-001	Driftwood
Z3102/466179-002	Boardwalk
Z3103/466179-003	Rattan
Z3104/466179-004	Alfresco
Z3105/466179-005	Plunge
Z3106/466179-006	Starboard
Z3107/466179-007	Veranda
Z3108/466179-008	Lodge
Z3109/466179-009	Flare

Shuttle Standard - Maharam	
54" wide	
84% post-industrial recycled polyester	
16% post-consumer recycled polyester	
ZSS16/466168-016	Clam
ZSS17/466168-017	Plateau
ZSS18/466168-018	Shoal

Strum - Maharam	
54" wide	
100% polyurethane with silver-based antimicrobial	
Z3301/466122-001	Overcast
Z3302/466122-002	Ridge
Z3303/466122-003	Twilight
Z3304/466122-004	Pigeon
Z3305/466122-005	Char
Z3306/466122-006	Cabin
Z3307/466122-007	Bur
Z3308/466122-008	Abalone
Z3309/466122-009	Prawn
Z3310/466122-010	Gourd
Z3311/466122-011	Wheat
Z3312/466122-012	Lemongrass

- Maharam textiles are on assigned lead times A unless otherwise noted.
- Fabric numbers are listed as Herman Miller fabric number/Maharam fabric number.

Maharam® Colors — Seating

continued

Price Category G

Coin Crypton - Maharam	
54" wide	
43% polyester	
37% post-industrial recycled polyester	
20% post-consumer recycled polyester	
Crypton Green finish and backing	
ZC901/466236-001	Nickel
ZC902/466236-002	Diner
ZC903/466236-003	Copper
ZC904/466236-004	Maroon
ZC905/466236-005	Penny
ZC906/466236-006	Exchange
ZC907/466236-007	Lead

Coincide High Performance-Maharam	
54" wide	
100% polyester	
ZCF02/466132-002	Drizzle
ZCF03/466132-003	Cicada
ZCF04/466132-004	Bungalow
ZCF07/466132-007	Raisin
ZCF10/466132-010	Woodland
ZCF11/466132-011	Acre

Colline - Maharam	
55" wide	
75% wool	
17% acrylic	
8% nylon	
ZCQ01/466155-108	108
ZCQ02/466155-118	118
ZCQ03/466155-148	148
ZCQ04/466155-188	188
ZCQ05/466155-228	228
ZCQ06/466155-348	348
ZCQ07/466155-448	448
ZCQ08/466155-548	548
ZCQ09/466155-568	568
ZCQ10/466155-668	668
ZCQ11/466155-688	688
ZCQ12/466155-788	788

Compound - Maharam	
54" wide	
100% polyurethane	
silane-based antimicrobial	
ZC201/466196-001	001
ZC202/466196-002	002
ZC203/466196-003	003
ZC204/466196-004	004
ZC205/466196-005	005
ZC206/466196-006	006
ZC207/466196-007	007
ZC208/466196-008	008
ZC209/466196-009	009
ZC210/466196-010	010
ZC211/466196-011	011
ZC212/466196-012	012
ZC213/466196-013	013
ZC214/466196-014	014
ZC215/466196-015	015
ZC216/466196-016	016
ZC217/466196-017	017
ZC218/466196-018	018
ZC219/466196-019	019

Disc Crypton - Maharam	
57" wide	
100% polyester	
Crypton finish and backing	
ZD204/466237-004	Vibrant
ZD205/466237-005	Somber
ZD207/466237-007	Steel

Divide Crypton - Maharam	
57" wide	
45% polyester	
36% post-industrial recycled polyester	
19% post-consumer recycled polyester	
Crypton Green finish and backing	
ZD401/466238-001	Ecru
ZD402/466238-002	Café
ZD403/466238-003	Concrete
ZD404/466238-004	Forest
ZD405/466238-005	Tropic
ZD406/466238-006	Lagoon
ZD407/466238-007	Mocha
ZD408/466238-008	Singe

Divina MD - Maharam	
59" wide	
100% wool	
Z2301/466150-193	193
Z2302/466150-203	203
Z2303/466150-213	213
Z2304/466150-293	293
Z2305/466150-343	343
Z2306/466150-353	353
Z2307/466150-363	363
Z2308/466150-413	413
Z2309/466150-433	433
Z2310/466150-453	453
Z2311/466150-613	613
Z2312/466150-633	633
Z2313/466150-653	653
Z2314/466150-673	673
Z2315/466150-683	683
Z2316/466150-713	713
Z2317/466150-733	733
Z2318/466150-743	743
Z2319/466150-753	753
Z2320/466150-773	773
Z2321/466150-783	783
Z2322/466150-813	813
Z2323/466150-843	843
Z2324/466150-873	873
Z2325/466150-913	913
Z2326/466150-943	943
Z2327/466150-973	973

Divina - Maharam	
59" wide	
100% wool	
TF01/460730-154	154
TF03/460730-171	171
TF04/460730-173	173
TF05/460730-181	181
TF06/460730-191	191
TF08/460730-224	224
TF10/460730-334	334
TF13/460730-384	384
TF14/460730-393	393
TF16/460730-444	444
TF17/460730-462	462
TF18/460730-542	542

- Maharam textiles are on assigned lead times ^A unless otherwise noted.
- Fabric numbers are listed as Herman Miller fabric number/Maharam fabric number.

Price category G continued on next page

Maharam® Colors — Seating

continued

Price Category G

continued

Divina continued	
TF19/460730-552	552
TF20/460730-562	562
TF22/460730-584	584
TF23/460730-623	623
TF25/460730-652	652
TF26/460730-662	662
TF27/460730-671	671
TF29/460730-684	684
TF30/460730-691	691
TF31/460730-692	692
TF33/460730-712	712
TF37/460730-742	742
TF41/460730-782	782
TF42/460730-791	791
TF43/460730-793	793
TF47/460730-893	893
TF49/460730-922	922
TF51/460730-944	944
TF53/460730-984	984
TF55/460730-106	106
TF56/460730-236	236
TF57/460730-246	246
TF58/460730-346	346
TF59/460730-356	356
TF60/460730-376	376
TF61/460730-426	426
TF62/460730-526	526
TF63/460730-536	536
TF64/460730-626	626
TF65/460730-636	636
TF66/460730-666	666
TF67/460730-676	676
TF68/460730-686	686
TF69/460730-696	696
TF70/460730-756	756
TF71/460730-826	826
TF72/460730-836	836
TF73/460730-846	846
TF74/460730-856	856
TF75/460730-876	876
TF76/460730-886	886
TF77/460730-936	936
TF78/460730-956	956
TF79/460730-966	966

Divina Melange — Maharam	
59" wide	
100% wool	
TG01/460830-120	120
TG02/460830-170	170
TG03/460830-180	180
TG04/460830-220	220
TG05/460830-260	260
TG06/460830-280	280
TG07/460830-871	871
TG08/460830-821	821
TG09/460830-771	771
TG10/460830-721	721
TG11/460830-731	731
TG12/460830-681	681
TG13/460830-631	631
TG15/460830-671	671
TG16/460830-581	581
TG17/460830-531	531
TG18/460830-521	521
TG19/460830-571	571
TG20/460830-421	421
TG21/460830-471	471
TG22/460830-931	931
TG24/460830-971	971
TG25/460830-925	925
TG26/460830-620	620

Emboss - Maharam	
54" wide	
100% polyurethane	
Polyester backing	
ZEM01/466281-001	Bronze
ZEM02/466281-002	Brass
ZEM03/466281-003	Gold
ZEM04/466281-004	Platinum
ZEM05/466281-005	Silver
ZEM06/466281-006	Aqua
ZEM07/466281-007	Aegean
ZEM08/466281-008	Cobalt
ZEM09/466281-009	Ultraviolet
ZEM10/466281-010	Copper
ZEM11/466281-011	Molten

Fold - Maharam	
54" wide	
100% polyurethane	
Polyester backing	
ZF101/466292-001	Jet
ZF102/466292-002	Chalk
ZF103/466292-003	Smoke
ZF104/466292-004	Putty
ZF105/466292-005	Fatigue
ZF106/466292-006	Splash
ZF107/466292-007	Apple
ZF108/466292-008	Moss
ZF109/466292-009	Graphite
ZF110/466292-010	Midnight

Hero by Kvadrat - Maharam	
55" wide	
96% wool	
4% nylon	
ZH101/466318-101	101
ZH102/466318-141	141
ZH103/466318-151	151
ZH104/466318-181	181
ZH105/466318-191	191
ZH106/466318-201	201
ZH107/466318-211	211
ZH108/466318-231	231
ZH109/466318-311	311
ZH110/466318-381	381
ZH111/466318-411	411
ZH112/466318-441	441
ZH113/466318-451	451
ZH114/466318-481	481
ZH115/466318-511	511
ZH116/466318-541	541
ZH117/466318-551	551
ZH118/466318-601	601
ZH119/466318-681	681
ZH120/466318-701	701
ZH121/466318-711	711

Hero by Kvadrat continued	
ZH122/466318-751	751
ZH123/466318-791	791
ZH124/466318-901	901
ZH125/466318-931	931
ZH126/466318-941	941
ZH127/466318-981	981
ZH128/466318-991	991

Omen - Maharam	
54" wide	
75% polyester	
16% post-industrial recycled polyester	
9% post-consumer recycled polyester	
ZQM01/466172-001	Clam
ZQM02/466172-002	Pewter
ZQM03/466172-003	Hazel
ZQM04/466172-004	Grain
ZQM05/466172-005	Bundle
ZQM07/466172-007	Glacier
ZQM08/466172-008	Surf
ZQM09/466172-009	Wade
ZQM10/466172-010	Marble
ZQM11/466172-011	Silt
ZQM12/466172-012	Persimmon
ZQM13/466172-013	Rocket

Pick Crypton - Maharam	
54" wide	
100% polyester	
Crypton finish and backing	
ZP102/466235-002	Olive
ZP103/466235-003	Slate
ZP104/466235-004	Espresso
ZP105/466235-005	Pepper
ZP106/466235-006	Masala
ZP107/466235-007	Fresh
ZP108/466235-008	Cool
ZP109/466235-009	Ink
ZP110/466235-010	Jet

Price category G continued on next page

- Maharam textiles are on assigned lead times **A** unless otherwise noted.
- Fabric numbers are listed as Herman Miller fabric number/Maharam fabric number.

Maharam® Colors — Seating

continued

Price Category G

continued

Pocket - Maharam	
54" wide	
76% recycled polyester	
24% nylon	
ZP301/466243-001	001
ZP302/466243-002	002
ZP303/466243-003	003
ZP304/466243-004	004
ZP305/466243-005	005
ZP306/466243-006	006
ZP307/466243-007	007

Ring - Maharam	
54" wide	
48% polyester	
34% post-industrial recycled polyester	
18% post-consumer recycled polyester	
ZRG02/466182-002	Flax
ZRG04/466182-004	Black
ZRG05/466182-005	Scarlet
ZRG06/466182-006	Rust
ZRG07/466182-007	Green
ZRG09/466182-009	Royal

Runner - Maharam	
54" wide	
57% post-industrial recycled polyester	
43% post-consumer recycled polyester	
ZRF01/466108-001	Bluff
ZRF02/466108-002	Arid
ZRF03/466108-003	Grove
ZRF04/466108-004	Starboard
ZRF05/466108-005	Plot
ZRF06/466108-006	Carousel

Sheen - Maharam	
54" wide	
100% polyurethane with silane-based antimicrobial	
ZSN01/466246-001	Sail
ZSN02/466246-002	Silver
ZSN03/466246-003	Pewter
ZSN04/466246-004	Hearth
ZSN05/466246-005	Fern
ZSN06/466246-006	Bog
ZSN07/466246-007	Cricket
ZSN08/466246-008	Clove
ZSN09/466246-009	Mystic
ZSN10/466246-010	Vat
ZSN11/466246-011	Huckleberry
ZSN12/466246-012	Mauve
ZSN13/466246-013	Brick
ZSN14/466246-014	Ruby
ZSN15/466246-015	Dragon
ZSN16/466246-016	Kumquat
ZSN17/466246-017	Cinnamon
ZSN18/466246-018	Alder

Steelcut - Maharam	
55" wide	
90% wool	
10% nylon	
ZSE01/464470-110	110
ZSE02/464470-120	120
ZSE03/464470-135	135
ZSE04/464470-140	140
ZSE05/464470-155	155
ZSE06/464470-160	160
ZSE07/464470-180	180
ZSE08/464470-190	190
ZSE09/464470-220	220
ZSE10/464470-240	240
ZSE11/464470-255	255
ZSE12/464470-265	265
ZSE13/464470-365	365
ZSE14/464470-370	370
ZSE15/464470-380	380
ZSE16/464470-435	435
ZSE17/464470-445	445
ZSE18/464470-535	535
ZSE19/464470-545	545
ZSE20/464470-550	550
ZSE21/464470-605	605
ZSE22/464470-615	615
ZSE23/464470-625	625
ZSE24/464470-635	635
ZSE25/464470-655	655
ZSE26/464470-660	660
ZSE27/464470-685	685
ZSE28/464470-695	695
ZSE29/464470-760	760
ZSE30/464470-775	775
ZSE31/464470-780	780
ZSE32/464470-820	820
ZSE33/464470-835	835
ZSE34/464470-935	935
ZSE35/464470-950	950
ZSE36/464470-975	975
ZSE37/464470-985	985

Steelcut Trio - Maharam	
55" wide	
90% wool	
10% nylon	
V2501/465906-105	105
V2502/465906-113	113
V2503/465906-124	124
V2504/465906-133	133
V2506/465906-153	153
V2507/465906-195	195
V2508/465906-205	205
V2509/465906-213	213
V2513/465906-253	253
V2514/465906-283	283
V2518/465906-383	383
V2523/465906-453	453
V2525/465906-515	515
V2526/465906-533	533
V2527/465906-553	553
V2529/465906-645	645
V2534/465906-713	713
V2542/465906-865	865
V2543/465906-883	883
V2544/465906-915	915
V2545/465906-933	933
V2546/465906-945	945
V2547/465906-953	953
V2548/465906-965	965
V2549/465906-983	983
V2550/465906-176	176
V2551/465906-226	226
V2552/465906-236	236
V2553/465906-246	246
V2554/465906-266	266
V2555/465906-276	276
V2556/465906-336	336
V2557/465906-376	376
V2558/465906-416	416
V2559/465906-426	426
V2560/465906-436	436
V2561/465906-446	446

Appendix: Maharam Colors — Seating

Price category G continued on next page

- Maharam textiles are on assigned lead times A unless otherwise noted.
- Fabric numbers are listed as Herman Miller fabric number/Maharam fabric number.

Maharam® Colors — Seating

continued

Price Category G

continued

Steelcut Trio *continued*

V2562/465906-466	466
V2563/465906-476	476
V2564/465906-506	506
V2565/465906-526	526
V2566/465906-576	576
V2567/465906-616	616
V2568/465906-636	636
V2569/465906-666	666
V2570/465906-686	686
V2571/465906-716	716
V2572/465906-746	746
V2573/465906-756	756
V2574/465906-776	776
V2575/465906-796	796
V2576/465906-806	806
V2577/465906-906	906
V2578/465906-916	916
V2579/465906-946	946
V2580/465906-966	966
V2581/465906-976	976
V2582/465906-996	996

Stride - Maharam

58" wide
40% post-industrial recycled polyester
39% polyester
21% post-consumer recycled polyester
PFOA-Free stain resistant finish
Acrylic backing
ZS103/466252-003 Midnight
ZS104/466252-004 Moss
ZS106/466252-006 Ember

Ticker - Maharam

54" wide
47% polyester
31% post-industrial recycled polyester
22% post-consumer recycled polyester
Crypton green finish and backing
ZT401/466304-001 Calm
ZT402/466304-002 Millet
ZT403/466304-003 Sow
ZT404/466304-004 Beaver
ZT405/466304-005 Patch
ZT406/466304-006 Balloon
ZT407/466304-007 Squad
ZT408/466304-008 Bale
ZT409/466304-009 Fecund
ZT410/466304-010 Aquarium
ZT411/466304-011 Drink
ZT412/466304-012 Depth
ZT413/466304-013 Far

Vestige - Maharam

54" wide
71% polyester
29% rayon
ZVT01/466259-001 001
ZVT02/466259-002 002
ZVT03/466259-003 003
ZVT04/466259-004 004
ZVT05/466259-005 005
ZVT06/466259-006 006
ZVT07/466259-007 007
ZVT08/466259-008 008
ZVT09/466259-009 009
ZVT10/466259-010 010

Price Category H

Circles — Maharam

55" wide
70% cotton
30% polyester
ZT01/458310-001 Khaki
ZT02/458310-002 Fatigue
ZT03/458310-003 Document
ZT04/458310-004 Engine
ZT05/458310-005 Charcoal

Crosspatch — Maharam

54" wide
75% rayon
25% polyester
ZS01/458920-001 Song
ZS02/458920-002 Fresh
ZS04/458920-004 Document
ZS06/458920-006 Circus
ZS08/458920-008 Grounded

Ditto — Maharam

54" wide
77% recycled polyester
23% solution dyed nylon
Z2D1/465993-001 Nacre
Z2D2/465993-002 Shadow
Z2D3/465993-003 Saddle
Z2D9/465993-009 Fern
Z2DA/465993-010 Fountain
Z2DB/465993-011 Cobalt
Z2DC/465993-012 Iron
Z2DD/465993-013 Driftwood

Dot Pattern — Maharam

55" wide
71% cotton
29% polyester
ZK01/458300-001 Document
ZK02/458300-002 Taupe
ZK04/458300-004 Red
ZK05/458300-005 Navy

Hallingdal - Maharam

51" wide
70% wool
30% rayon
Z2401/460760-100 100
Z2402/460760-103 103
Z2403/460760-110 110
Z2404/460760-113 113
Z2405/460760-116 116
Z2406/460760-123 123
Z2407/460760-126 126
Z2408/460760-130 130
Z2409/460760-143 143
Z2410/460760-153 153
Z2411/460760-166 166
Z2412/460760-173 173
Z2413/460760-180 180
Z2414/460760-190 190
Z2415/460760-200 200
Z2416/460760-220 220
Z2417/460760-224 224
Z2418/460760-227 227
Z2419/460760-270 270
Z2420/460760-350 350
Z2421/460760-368 368
Z2422/460760-370 370
Z2423/460760-376 376
Z2424/460760-390 390
Z2425/460760-407 407
Z2426/460760-420 420
Z2427/460760-457 457
Z2428/460760-526 526
Z2429/460760-547 547
Z2430/460760-563 563
Z2431/460760-573 573
Z2432/460760-590 590
Z2433/460760-596 596
Z2434/460760-600 600
Z2435/460760-657 657
Z2436/460760-660 660
Z2437/460760-674 674
Z2438/460760-680 680
Z2439/460760-687 687

Price category H continued on next page

- Maharam textiles are on assigned lead times **A** unless otherwise noted.
- Fabric numbers are listed as Herman Miller fabric number/Maharam fabric number.

Maharam® Colors — Seating

continued

Price Category H

continued

Hallingdal continued

Z2440/460760-694	694
Z2441/460760-702	702
Z2442/460760-723	723
Z2443/460760-733	733
Z2444/460760-750	750
Z2445/460760-753	753
Z2446/460760-754	754
Z2447/460760-763	763
Z2448/460760-764	764
Z2449/460760-773	773
Z2450/460760-810	810
Z2451/460760-840	840
Z2452/460760-850	850
Z2453/460760-890	890
Z2454/460760-907	907
Z2455/460760-944	944
Z2456/460760-960	960
Z2457/460760-968	968
Z2458/460760-980	980

Offset – Maharam

54" wide	
40% cotton	
36% nylon	
24% wool	
ZQF01/465951-001	Passage
ZQF02/465951-002	Fieldstone
ZQF03/465951-003	Coast
ZQF04/465951-004	Esplanade
ZQF05/465951-005	Oasis
ZQF06/465951-006	Spice
ZQF07/465951-007	Bloom

Small Dot Pattern — Maharam

55" wide	
71% cotton	
29% polyester	
ZL01/458320-001	Document
ZL02/458320-002	Sand
ZL03/458320-003	Khaki
ZL04/458320-004	Taupe
ZL05/458320-005	Charcoal
ZL06/458320-006	Document
Reverse	
ZL07/458320-007	Red
ZL08/458320-008	Yellow
ZL09/458320-009	Green

Tonus - Maharam

51" wide	
90% wool	
10% helanka	
ZTN01/460800-100	100
ZTN03/460800-109	109
ZTN05/460800-118	118
ZTN10/460800-125	125
ZTN13/460800-128	128
ZTN14/460800-129	129
ZTN15/460800-130	130
ZTN16/460800-131	131
ZTN17/460800-132	132
ZTN19/460800-135	135
ZTN21/460800-207	207
ZTN23/460800-210	210
ZTN26/460800-216	216
ZTN27/460800-240	240
ZTN29/460800-440	440
ZTN32/460800-508	508

Tonus continued

ZTN34/460800-605	605
ZTN35/460800-608	608
ZTN36/460800-609	609
ZTN37/460800-610	610
ZTN38/460800-613	613
ZTN40/460800-615	615
ZTN41/460800-619	619
ZTN51/460800-631	631
ZTN54/460800-634	634
ZTN56/460800-636	636
ZTN59/460800-690	690
ZTN62/460800-840	840
ZTN63/460800-940	940
ZTN65/460800-224	224
ZTN66/460800-244	244
ZTN67/460800-364	364
ZTN68/460800-374	374
ZTN69/460800-394	394
ZTN70/460800-424	424
ZTN71/460800-454	454
ZTN72/460800-464	464
ZTN73/460800-474	474
ZTN74/460800-554	554
ZTN75/460800-654	654
ZTN76/460800-664	664
ZTN77/460800-684	684
ZTN78/460800-754	754
ZTN79/460800-764	764
ZTN80/460800-854	854
ZTN81/460800-914	914
ZTN82/460800-934	934
ZTN83/460800-954	954
ZTN84/460800-964	964
ZTN85/460800-974	974

Price Category I

Latch - Maharam

55" wide	
61% cotton	
39% solution-dyed post-industrial recycled nylon	
16% rayon	
PFOA-Free stain resistant finish	
Acrylic backing	
ZLC01/466301-001	Rescue
ZLC02/466301-002	Guide
ZLC03/466301-003	Rotary
ZLC04/466301-004	Radar
ZLC05/466301-005	Sphere
ZLC06/466301-006	Solemn

Teatro - Maharam

55" wide	
100% polyester	
Polyester/Cotton backing	
ZT201/466309-001	Crumb
ZT202/466309-002	Dorper
ZT203/466309-003	Herd
ZT204/466309-004	Deep
ZT205/466309-005	Robe
ZT206/466309-006	Heat
ZT207/466309-007	Caspian
ZT208/466309-008	Misty
ZT209/466309-009	Boulder
ZT210/466309-010	Elixir
ZT211/466309-011	Guard
ZT212/466309-012	Throne

- Maharam textiles are on assigned lead times ^A unless otherwise noted.
- Fabric numbers are listed as Herman Miller fabric number/Maharam fabric number.

Maharam® Colors — Seating

continued

Appendix: Maharam Colors — Seating

Price Category J	Price Category K	Price Category L	Price Category M
Tokyo - Maharam 59" wide 67% wool 24% polyester 9% nylon ZT101/466247-112 112 ZT102/466247-132 132 ZT103/466247-182 182 ZT104/466247-242 242 ZT105/466247-252 252 ZT106/466247-352 352 ZT107/466247-432 432 ZT108/466247-632 632 ZT109/466247-652 652 ZT110/466247-682 682 ZT111/466247-692 692 ZT112/466247-732 732 ZT113/466247-782 782 ZT114/466247-952 952 ZT115/466247-982 982	Coda by Kvadrat - Maharam 55" wide 90% wool 10% nylon ZC701/464480-100 100 ZC702/464480-103 103 ZC703/464480-116 116 ZC704/464480-182 182 ZC705/464480-222 222 ZC706/464480-232 232 ZC707/464480-242 242 ZC708/464480-362 362 ZC709/464480-382 382 ZC710/464480-410 410 ZC711/464480-422 422 ZC712/464480-442 442 ZC713/464480-610 610 ZC714/464480-632 632 ZC715/464480-642 642 ZC716/464480-722 722 ZC717/464480-762 762 ZC718/464480-962 962	Minicheck - Maharam 55" wide 78% cotton 22% polyester PFOA-Free stain resistant finish ZMK01/466268-001 Black/White	Fruit - Maharam 54" wide 55% cotton 32% nylon 13% post-consumer recycled polyester PFOA-Free stain resistant finish Acrylic backing ZF201/466262-001 Opal ZF202/466262-002 Lime ZF203/466262-003 Olive ZF204/466262-004 Sky ZF205/466262-005 Kernal ZF206/466262-006 Droplet ZF207/466262-007 Russet

- Maharam textiles are on assigned lead times A unless otherwise noted.
- Fabric numbers are listed as Herman Miller fabric number/Maharam fabric number.

Maharam® Colors — Seating

continued

Price Category N-Z

No fabrics available at this time.

- Maharam textiles are on assigned lead times **A** unless otherwise noted.
- Fabric numbers are listed as Herman Miller fabric number/Maharam fabric number.

For more information about our products and services or to see a list of dealers, please visit us at HermanMiller.com or call (800) 851 1196.

© 2018 Herman Miller, Inc., Zeeland, Michigan

® **HermanMiller**, 3D Intelligent, AO, Action Office, Aeron, ArcSpan, Aside, Avall, Avive, Bubble Lamps, Canvas Office Landscape, Caper, Celle, Co/Struc, Daisiyone, Distil, Eames, Eco-Dematerialized, Embody, Envelop, Equa 2, Ergon 3, Ethospace, Exclave, Fine-Tune, FlexFront, Flo, Formcoat, Formwork, Ground Cloth, Herman Miller for the Home, Herman Miller for Healthcare, Intersect, Kinemat, Lapjack, Layout Studio, Lifework, Limerick, Live Unframed, Living Office, Locale, Maharam, Meridian, Mirra, Passage, Pellicle, Perspectives, PostureFit, Public Office Landscape, Resolve, Rodney, Sayl, Setu, Thrive, Tu, Wishbone, and Y-Tower are among the registered trademarks of Herman Miller, Inc., and its owned subsidiaries.

™ 8Z Pellicle, About Face, AireWeave, Albert, Backfit, Bubbletack, Burdick Group, Butterfly Back, Celeste, Cellular Suspension, Clam, Compass, Connect, Cosm, Cubert, DOT, Duracare, Durawrap, Eames Soft Pad, EnhancedAccess, Everywhere, Flex-Edge, Flute, Harmonic, Herman Miller Select, Hopsak 2, Intent, Iota, Jaw, Keyless Entry, Keyn Chair Group by Herman Miller, Latitude, Lino, Locale, Logic Mini, Logic Power Access Solutions, Live OS, Loop, Lyris, Lyris 2, Made-to-Measure Storage, Metaform Portfolio, Mora, Motia, Multiscrim, Nelson, Pari, Pixelated Support, Plex, PostureFit SL, Prospect, Q, Renew, Sense, Soft Pad, Stackable, Stackable Storage, Striad, Swoop, Tone, TriFlex, Twist, Ubi, Verus and Wireframe are among the trademarks of Herman Miller, Inc., and its owned subsidiaries.

SM Herman Miller Options is among the service marks of Herman Miller, Inc.

Alexander Girard® is a registered trademark of The Alexander Girard Estate.

Chemsurf® is a registered trademark of Wilsonart International.

Corian® is a registered trademark of E. I. du Pont de Nemours and Company Corporation.

Crypton® is a registered trademark of Crypton, Inc.

DACRON® is a registered trademark of INVISTA S.a r.l.

Edelman® Leather is a registered trademark of Edelman Leather, Inc.

FENIX NTM® is a registered trademark of Arpa Industriale S.p.A.

FLEXNET™ is a trademark of Milliken & Company.

Floor Saver Glide® is a registered trademark of Carpin Manufacturing, Inc.

Geiger® is a registered trademark, and Bumper™, Saiba™, and Ward Bennett™ are trademarks, of Geiger International.

Goetz™ is a trademark of Mark W. Goetz.

Hang-It-All® is a registered trademark of Lucia Eames Demetrios, d.b.a. Eames Office.

Holophane® is a registered trademark of Holophane.

Ingeo™ is a trademark of Cargill Dow LLC.

iPad® is a registered trademark of Apple, Inc.

LifeSize® is a registered trademark of LifeSize Communications, Inc.

Magis®, Bombo®, and Me Too® are registered trademarks of Magis S.p.A.

Microsoft® and Natural® Keyboard are registered trademarks of Microsoft Corporation.

Noguchi® and the Noguchi table configuration (trade dress) are registered trademarks, and Rudder Table™ is a trademark, of The Isamu Noguchi Foundation and Garden Museum.

Place Textiles® is a registered trademark of Place Textiles.

SuperSeat™ is a trademark of Dahti Seating, a division of ITW.